

# CATÁLOGO GENERAL



# GASOLINA



# ÍNDICE

## ÍNDICE

Presentación .....	V
Garantía .....	VII

### CATÁLOGO 2012

#### SECCIÓN I

Diagramación .....	2
<i>Consecutivo Soportes Automotrices</i> .....	3
Soportes especiales .....	25

#### SECCIÓN II

Diagramación .....	28
--------------------	----

Acura .....	29	Mazda .....	178
Audi .....	32	Mercedes Benz .....	188
BMW .....	33	Mitsubishi .....	190
Chevrolet .....	34	Nissan .....	196
Chrysler .....	92	Peugeot .....	215
Dodge .....	109	Rambler .....	217
Ford .....	121	Renault .....	218
Honda .....	155	Seat .....	220
Hundai .....	164	Subarú .....	221
Infiniti .....	165	Suzuki .....	222
Isuzu .....	167	Toyota .....	225
Jeep .....	171	Volkswagen .....	238
Lexus .....	177	Nuevos Varios .....	247

# ÍNDICE

## ÍNDICE

Presentación .....	V
Garantía .....	VII

### CATÁLOGO 2012

#### SECCIÓN I

Diagramación .....	2
<i>Consecutivo Soportes Automotrices</i> .....	3
Soportes especiales .....	25

#### SECCIÓN II

Diagramación .....	28
--------------------	----

Acura .....	29	Mazda .....	178
Audi .....	32	Mercedes Benz .....	188
BMW .....	33	Mitsubishi .....	190
Chevrolet .....	34	Nissan .....	196
Chrysler .....	92	Peugeot .....	215
Dodge .....	109	Rambler .....	217
Ford .....	121	Renault .....	218
Honda .....	155	Seat .....	220
Hundai .....	164	Subarú .....	221
Infiniti .....	165	Suzuki .....	222
Isuzu .....	167	Toyota .....	225
Jeep .....	171	Volkswagen .....	238
Lexus .....	177	Nuevos Varios .....	247

# ÍNDICE

---

## ÍNDICE

### SECCIÓN III

#### MISCELÁNEA HULE-METAL

Aumento Resorte .....	249
Barra Estabilizadora .....	250
Base Amortiguador .....	256
Buje Suspensión .....	258
Caliper .....	271
Cardanes .....	273
Castas/Chasis .....	275
Fuelles .....	278
Golletes .....	281
Gomas Alternador .....	282
Gomas Amortiguador .....	283
Gomas Cofre .....	284
Gomas Dirección .....	287
Gomas Escape .....	289
Gomas Muelle .....	291
Gomas Varias .....	293
Pedales .....	295
Punterías (Gomas) .....	300
Tapón de Agua (Gomas) .....	301
Radiador (Gomas) .....	301
Rebote (Gomas) .....	303
Rótulas (Cubre Polvo) .....	305
Topes Cofre (Niveladores) .....	307
Suspensión (Topes) .....	311
Sordinas (Topes) .....	313
Tornillos Estabilizadores .....	314
Válvulas .....	315
Machetas Santoprene .....	317
Abrazaderas Metal .....	326
Directorio .....	327

MR

# PRESENTACIÓN

---

## **Bufalo AHM**

Empresa 100% mexicana que surge en los años 50's bajo el nombre de Artefactos de Hule México como un negocio familiar en busca del sueño de lograr ser una de las empresas más fuertes en el mercado de las Auto Partes Hule Metal.

Años mas tarde y después de una reestructuración integral se cambia el nombre a Bufalo AHM y se incorpora en el logo el Bufalo americano, ejemplar que nos representa por la fuerza que simboliza.

Bufalo AHM, es una empresa con más de 50 años de experiencia dentro del mercado nacional e internacional en la fabricación de productos Automotrices Hule Metal con las normas de calidad más altas.

Valores como la honestidad, respeto, responsabilidad, compromiso y lealtad nos representan día a día con cada uno de nuestros clientes y socios comerciales.

## **Bufalo AHM**

Una empresa líder en ventas en el mercado nacional e internacional, siendo así la primera opción de compra por la calidad, garantía y precio de todos nuestro productos, con el mercado de distribución más grande a nivel nacional y con el personal mas calificado, brindamos a todos nuestros clientes un excelente servicio y accesoria técnica.

CATÁLOGO  
*Dosmil12*

GRUPO BUFALO AHM



MR

# CATÁLOGO

## *Dosmil12*

# GARANTÍA

## GARANTÍA

Todos nuestros productos se garantizan por dos años ó 40,000 Kms. contra cualquier defecto de material o fabricación en uso y condiciones normales.

Nuestros soportes están fabricados bajo las más altas normas de calidad y de fabricación automotriz. Todos los productos son sometidos a largas pruebas que dan como resultado una excelente amortiguación, resistencia y duración, que garantiza la calidad en sus materiales y procesos de fabricación.

Dado el caso, la empresa solo substituirá con producto equivalente (*cambio físico*) a la(s) pieza(s) que resultara(n) defectuosa(as).

La empresa no asume responsabilidad alguna por instalación incorrecta, daños consecuentes o incidentales en ningún caso.

No se aceptarán cargos por ningún otro concepto.

## ABREVIATURAS

<b>1a V.</b> PRIMERA VERSIÓN	<b>Ext.</b> EXTERIOR	<b>Jgo.</b> JUEGO	<b>Rep.</b> REPUESTOS
<b>Aut.</b> AUTOMÁTICO	<b>Front.</b> FRONTAL	<b>Lat.</b> LATERAL	<b>Sop.</b> SOPORTE
<b>Cil.</b> CILINDRO	<b>Hidra.</b> HIDRÁULICO	<b>Long.</b> LONGITUD	<b>Sup.</b> SUPERIOR
<b>CIAC</b> CON AIRE ACONDICIONADO	<b>Inf.</b> INFERIOR	<b>Lts.</b> LITROS	<b>Std.</b> ESTANDAR
<b>Del.</b> DELANTERO	<b>Izq.</b> IZQUIERDA	<b>Mod.</b> MODELO	<b>Tras.</b> TRASERO
<b>Der.</b> DERECHO	<b>Int.</b> INTERIOR	<b>Mot.</b> MOTOR	<b>Vel.</b> VELOCIDADES





# BUFALO AHM

---

## CATÁLOGO



MR

**CONSECUTIVO  
SOPORTES AUTOMOTRICES**

**AUTOS, TODO TERRENO,  
PICK UP Y VAN**

---

SECCIÓN I



# DIAGRAMACIÓN

AUTOS Y CAMIONETAS

**NÚMERO DE PIEZA**

**1111**

**FOTOGRAFÍA DE PIEZA**



**PÁGINA UBICACIÓN**

**38**

**NOTA: TODAS LAS FOTOGRAFÍAS USADAS TIENEN UN FIN ILUSTRATIVO Y NO CORRESPONDEN AL TAMAÑO ORIGINAL. ( PARA MAYORES INFORMES ACERCA DE CUALQUIER PRODUCTO, CONSULTE A SU DISTRIBUIDOR AUTORIZADO)**

# CONSECUTIVO

AUTOS Y CAMIONETAS



<p><b>200</b></p>  <p>63</p>	<p><b>200-A</b></p>  <p>83</p>	<p><b>200-B</b></p>  <p>83</p>	<p><b>218</b></p>  <p>83</p>	<p><b>219</b></p>  <p>83</p>
<p><b>223</b></p>  <p>60, 63, 80, 82, 171, 175</p>	<p><b>223-A</b></p>  <p>42, 59, 63, 82</p>	<p><b>240*</b></p>  <p>139, 149</p>	<p><b>254*</b></p>  <p>148</p>	<p><b>500</b></p>  <p>244</p>
<p><b>513*</b></p>  <p>126, 134</p>	<p><b>514*</b></p>  <p>126, 134</p>	 <p>MR</p>	<p><b>515*</b></p>  <p>126, 134</p>	<p><b>517</b></p>  <p>129</p>
<p><b>520</b></p>  <p>141, 148, 152</p>	<p><b>521</b></p>  <p>148</p>	<p><b>539</b></p>  <p>113, 115</p>	<p><b>541</b></p>  <p>113</p>	<p><b>542*</b></p>  <p>113</p>
<p><b>546</b></p>  <p>217</p>	<p><b>552</b></p>  <p>244</p>	<p><b>565</b></p>  <p>93, 97, 108</p>	<p><b>568*</b></p>  <p>113</p>	<p><b>571</b></p>  <p>129</p>
<p><b>572</b></p>  <p>129</p>	<p><b>573</b></p>  <p>198</p>	<p><b>574</b></p>  <p>198</p>	 <p>MR</p>	<p><b>575*</b></p>  <p>113</p>
<p><b>579-A</b></p>  <p>93, 97, 108</p>	<p><b>585</b></p>  <p>93, 97, 108</p>	<p><b>587</b></p>  <p>129</p>	<p><b>588</b></p>  <p>132</p>	<p><b>598*</b></p>  <p>126, 134</p>



# CONSECUTIVO

AUTOS Y CAMIONETAS

<b>599*</b>  126, 134	<b>709</b>  217	<b>711</b>  29, 43, 52, 59, 60, 79, 82	<b>715*</b>  126	<b>716*</b>  126
<b>718</b>  244	<b>720</b>  217		<b>721</b>  198	<b>722</b>  43, 80, 82, 83, 85, 87
<b>722-A</b>  43, 80, 82, 83, 85, 87	<b>723</b>  198	<b>724</b>  97, 108	<b>725</b>  97, 108	<b>726</b>  108
<b>726-A</b>  108	<b>727</b>  42, 43, 59, 82, 83, 84	<b>728</b>  171	<b>729</b>  171, 175	<b>730</b>  220
<b>731</b>  220	<b>732</b>  217	<b>734</b>  244	<b>734-A</b>  239	<b>735</b>  112, 113
	<b>738</b>  198	<b>739</b>  125, 134	<b>739-A</b>  125	<b>740</b>  125, 134
<b>740-A</b>  125	<b>741</b>  112, 113	<b>743</b>  97, 108, 111, 112	<b>744</b>  219	<b>745</b>  219

# CONSECUTIVO

AUTOS Y CAMIONETAS

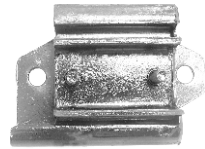

<p><b>746</b></p>  <p>219</p>	<p><b>754</b></p>  <p>239</p>	<p><b>761</b></p>  <p>238</p>	 <p>MR 63</p>	<p><b>761-A</b></p>  <p>238</p>
<p><b>762</b></p>  <p>141, 148, 152</p>	<p><b>766</b></p>  <p>238</p>	<p><b>768</b></p>  <p>217</p>	<p><b>769</b></p>  <p>130, 141, 148, 152, 153</p>	<p><b>775</b></p>  <p>198</p>
<p><b>777</b></p>  <p>239</p>	<p><b>778</b></p>  <p>220</p>	 <p>MR</p>	<p><b>779</b></p>  <p>148</p>	<p><b>780</b></p>  <p>148</p>
<p><b>781*</b></p>  <p>134</p>	<p><b>782*</b></p>  <p>220</p>	<p><b>786</b></p>  <p>220</p>	<p><b>787*</b></p>  <p>198, 244</p>	<p><b>788</b></p>  <p>97, 99, 101, 103, 105, 119</p>
<p><b>790</b></p>  <p>121, 125, 134, 139</p>	<p><b>791</b></p>  <p>97, 101, 103, 105, 119</p>	<p><b>792</b></p>  <p>124, 131, 138</p>	<p><b>792-A</b></p>  <p>124, 131, 138</p>	<p><b>793</b></p>  <p>97, 99, 101, 103, 105, 119</p>
<p><b>794</b></p>  <p>37, 40, 42, 43, 44, 49, 50, 51 58, 62, 70, 72, 73, 89, 90, 91</p>	<p><b>794-R</b></p>  <p>37, 40, 42, 43, 44, 49, 50, 51 58, 62, 70, 72, 73, 89, 90, 91</p>	<p><b>797</b></p>  <p>198, 208, 210, 211</p>	<p><b>797-A</b></p>  <p>215</p>	<p><b>799</b></p>  <p>210</p>
<p><b>800</b></p>  <p>138</p>	<p><b>800-C</b></p>  <p>138</p>	<p><b>802</b></p>  <p>138</p>	<p><b>802-B</b></p>  <p>138</p>	<p><b>803</b></p>  <p>205</p>



# CONSECUTIVO

AUTOS Y CAMIONETAS

<b>803-R</b>  205	<b>804</b>  37, 40, 42, 43, 44 49, 52, 53, 62, 72, 89, 90, 91	<b>805</b>  40 42, 43, 44, 49, 72, 89, 90, 91	<b>806</b>  97, 99, 101, 103, 105, 119	<b>810</b>  125, 134
<b>820</b>  239, 243	<b>821</b>  217	<b>823</b>  138	<b>823-A</b>  141, 148	<b>824</b>  40, 42, 43, 44, 49, 72
<b>825</b>  112, 114, 116		<b>827</b>  205	<b>827-A</b>  205	<b>827-R</b>  205
<b>829</b>  205	<b>829-R</b>  205	<b>832</b>  205	<b>833</b>  198, 202, 205	<b>834</b>  198, 202, 205
<b>835</b>  205, 206	<b>835-A</b>  205, 206	<b>835-B</b>  153, 206	<b>835-BC</b>  200, 213	<b>836</b>  40, 42, 44 49, 51, 70, 72, 73, 89, 90, 91
<b>839</b>  141, 148	<b>840</b>  113	<b>841</b>  240, 243	<b>841-A</b>  240	<b>841-273A</b>  241
<b>841-273C</b>  220, 241	<b>843</b>  239	<b>846</b>  49, 58, 60, 79, 80, 83, 89	<b>848</b>  220, 240, 241, 243	<b>848-A</b>  220, 221, 240, 243

# CONSECUTIVO

AUTOS Y CAMIONETAS



<p><b>850</b></p> <p>99, 101, 103, 105, 117, 119</p>	<p><b>851</b></p> <p>99, 103, 105, 117, 119</p>		<p><b>852</b></p> <p>99, 105, 117, 119</p>	<p><b>855</b></p> <p>122, 136, 137, 139, 153</p>
<p><b>860</b></p> <p>137</p>	<p><b>860-A</b></p> <p>136, 137</p>	<p><b>860-B</b></p> <p>137, 153</p>	<p><b>862</b></p> <p>113</p>	<p><b>863</b></p> <p>112, 113</p>
<p><b>864</b></p> <p>198</p>	<p><b>865</b></p> <p>210, 211</p>	<p><b>866</b></p> <p>36, 40, 45, 49, 57, 72</p>	<p><b>867</b></p> <p>240, 243</p>	<p><b>871</b></p> <p>244</p>
<p><b>872</b></p> <p>244</p>	<p><b>873</b></p> <p>138</p>	<p><b>874</b></p> <p>195, 201, 206</p>	<p><b>875</b></p> <p>138</p>	<p><b>876</b></p> <p>138</p>
<p><b>877</b></p> <p>80, 82, 83, 86</p>	<p><b>879</b></p> <p>196, 198, 211</p>	<p><b>880</b></p> <p>141, 148, 152</p>	<p><b>880-A</b></p> <p>141, 143, 148, 149</p>	<p><b>882</b></p> <p>36, 40, 45, 49, 57, 72</p>
<p><b>884</b></p> <p>94, 100, 107</p>	<p><b>885</b></p> <p>76, 81, 116</p>	<p><b>890</b></p> <p>36, 40, 45, 49, 57, 72</p>	<p><b>890-A</b></p> <p>40, 45, 49, 57</p>	<p><b>891</b></p> <p>141, 148, 152</p>
<p><b>891-A</b></p> <p>141, 148, 152</p>	<p><b>893</b></p> <p>94, 100, 107</p>	<p><b>894</b></p> <p>97, 99, 101, 103, 105, 119</p>	<p><b>895</b></p> <p>208, 210, 211</p>	<p><b>896</b></p> <p>240</p>



# CONSECUTIVO

AUTOS Y CAMIONETAS

<b>896-A</b>  240	<b>897</b>  138	<b>897-A</b>  124, 131, 138	<b>898</b>  39, 49, 75, 78, 80, 82	<b>899</b>  36, 40, 45, 49, 57, 72
<b>900</b>  195, 201, 206	<b>900-R</b>  195, 201, 206	<b>904</b>  122, 139		<b>905</b>  122
<b>906-A</b>  218	<b>907-A</b>  218	<b>908</b>  239	<b>909</b>  141, 148	<b>910</b>  141, 148
<b>912-A</b>  198, 202, 210, 211	<b>913</b>  121, 123, 133	<b>914</b>  121, 133	<b>915</b>  121, 123, 133	<b>916-A</b>  210, 211
<b>917</b>  94, 95, 96, 104, 106, 107, 108	<b>918</b>  94, 95, 96, 104, 106, 107, 108	<b>919</b>  46, 52, 60, 65, 75, 78, 86, 88	<b>920</b>  125, 140, 179, 182, 184	
<b>921</b>  125, 140, 179, 182, 184	<b>922</b>  43	<b>922-A</b>  43	<b>923</b>  43	<b>928-A</b>  124, 130, 139
<b>929</b>  100, 107	<b>930</b>  39, 42, 49, 52, 77, 78, 79, 80, 82, 85, 86, 87, 88, 89, 169, 171	<b>931</b>  34, 36, 40, 45, 57, 63, 72	<b>932</b>  201, 203, 206	<b>932-R</b>  201, 203, 206, 213



# CONSECUTIVO

AUTOS Y CAMIONETAS



<p><b>933</b></p>  <p>75, 78, 86, 169</p>	<p><b>935</b></p>  <p>84, 11, 114, 173, 174</p>	<p><b>936</b></p>  <p>34, 36, 40, 45, 49, 57, 72</p>	<p><b>938</b></p>  <p>124, 131, 138</p>	<p><b>938-A</b></p>  <p>138</p>
<p><b>939</b></p>  <p>150</p>	<p><b>940</b></p>  <p>150</p>	<p><b>941</b></p>  <p>142, 144 145, 150, 151, 184, 186, 187</p>	<p><b>942</b></p>  <p>205, 206</p>	<p><b>943</b></p>  <p>206</p>
<p><b>947</b></p>  <p>243</p>	<p><b>950</b></p>  <p>94, 95, 96, 104, 106, 107, 108</p>	<p><b>953</b></p>  <p>101, 105</p>	<p><b>956</b></p>  <p>43</p>	<p><b>956-A</b></p>  <p>43</p>
<p><b>957</b></p>  <p>117, 119</p>	<p><b>958</b></p>  <p>117, 119</p>	<p><b>959</b></p>  <p>96, 98, 99, 101, 110</p>	<p><b>961</b></p>  <p>127</p>	<p><b>963</b></p>  <p>125, 179, 182, 184</p>
<p><b>963-A</b></p>  <p>125, 143</p>	<p><b>963-R</b></p>  <p>125, 143, 179, 182, 184</p>	<p><b>964</b></p>  <p>125, 143, 179, 182, 184</p>	<p><b>964-R</b></p>  <p>125, 143, 179, 182, 184</p>	<p><b>965</b></p>  <p>195, 200, 203, 206</p>
<p><b>967</b></p>  <p>94, 95, 96, 104, 106, 107, 108</p>	<p><b>970*</b></p>  <p>239</p>	<p><b>971</b></p>  <p>99, 115, 192, 193, 194</p>	<p><b>971-A</b></p>  <p>55, 227, 230, 235, 236</p>	<p><b>972</b></p>  <p>185, 186</p>
<p><b>973</b></p>  <p>29, 158, 159, 161</p>	<p><b>974</b></p>  <p>29, 158, 159, 161</p>	<p><b>975</b></p>  <p>121, 133</p>	<p><b>976</b></p>  <p>43</p>	<p><b>977</b></p>  <p>43</p>



# CONSECUTIVO

AUTOS Y CAMIONETAS

<b>978</b>  125, 140, 182, 184	<b>978-R</b>  125, 140, 182, 184	<b>979</b>  158, 161	<b>980</b>  197, 200, 203	<b>981</b>  34, 36, 40, 45, 57, 63, 72
<b>982</b>  49, 57, 65	<b>982-A</b>  49, 57, 65	<b>983</b>  34, 40, 45, 57, 65, 72	<b>983-A</b>  34, 37, 45, 57, 63, 72	<b>984</b>  100, 102
<b>985</b>  52, 76, 78, 86	<b>987/986</b>  100, 102	<b>987/986A</b>  100, 102	<b>988</b>  220, 241, 243	<b>989</b>  220, 241, 243
<b>991</b>  75	<b>992</b>  117, 119	<b>993</b>  29, 156, 158, 159, 160, 161	<b>994</b>  629, 40, 1583	<b>995</b>  197, 200, 201, 203, 207
<b>995-A</b>  197, 200	<b>996</b>  127	<b>996-A</b>  127	<b>997</b>  240	<b>998</b>  92
<b>999</b>  166, 208, 214	<b>1000</b>  206	<b>1001</b>  127, 128		<b>1003</b>  92
<b>1004</b>  92	<b>1005</b>  35, 44, 74	<b>1006</b>  35, 44, 66, 88	<b>1007</b>  35, 44, 74	<b>1008</b>  64, 65

# CONSECUTIVO

AUTOS Y CAMIONETAS



<p><b>1011</b></p> <p>173</p>	<p><b>1012</b></p> <p>195, 197, 200, 201, 203, 204</p>	<p><b>1013</b></p> <p>114</p>	<p><b>1014</b></p> <p>35, 74</p>	<p><b>1015</b></p> <p>57, 65</p>
<p><b>1016</b></p> <p>35, 74</p>	<p><b>1017</b></p> <p>84, 85</p>	<p><b>1017-A</b></p> <p>82, 83</p>	<p><b>1017-B</b></p> <p>87</p>	<p><b>1018</b></p> <p>202, 218, 219</p>
<p><b>1018-C</b></p> <p>202, 218, 219</p>	<p><b>1019</b></p> <p>240</p>	<p><b>1019-A</b></p> <p>240</p>	<p><b>1022</b></p> <p>127</p>	<p><b>1023</b></p> <p>197, 202, 218</p>
<p><b>1023-C</b></p> <p>197, 202, 218</p>	<p><b>1024</b></p> <p>127, 130, 146</p>	<p><b>1024-C</b></p> <p>127, 130, 146</p>	<p><b>1025</b></p> <p>206</p>	<p><b>1026</b></p> <p>214</p>
<p><b>1027</b></p> <p>214</p>	<p><b>1027-A</b></p> <p>214</p>	<p><b>1028</b></p> <p>92, 123</p>	<p><b>1030</b></p> <p>219</p>	<p><b>1033</b></p> <p>95, 104, 106, 108</p>
<p><b>1034</b></p> <p>95, 104, 106, 108</p>	<p><b>1036</b></p> <p>240</p>	<p><b>1037</b></p> <p>202, 218</p>	<p><b>1038</b></p> <p>131</p>	<p><b>1039</b></p> <p>218</p>
<p><b>1040</b></p> <p>127, 130, 146</p>	<p><b>1041</b></p> <p>197, 203, 204</p>	<p><b>1044</b></p> <p>197, 202</p>	<p><b>1045</b></p> <p>197, 202</p>	<p><b>1045-A</b></p> <p>197, 202, 204</p>



# CONSECUTIVO

AUTOS Y CAMIONETAS

<b>1045-B</b>  165, 197, 200, 212	<b>1046</b>  44, 66, 88	<b>1047</b>  65	<b>1051</b>  100, 102	<b>1052</b>  197, 200, 202, 207, 213
<b>1052-B</b>  197, 200, 207	<b>1053</b>  92	<b>1056</b>  215, 216, 217	<b>1057</b>  77, 79, 80, 82, 87, 88, 164, 229	<b>1058</b>  215, 217
<b>1058-A</b>  215, 216	<b>1059</b>  215, 216, 217	<b>1061</b>  44, 66, 88	<b>1061-R</b>  44, 66, 88	<b>1062</b>  142
<b>1062-A</b>  127	<b>1063</b>  203	<b>1063-R</b>  203	<b>1066</b>  92	<b>1067</b>  92
<b>1068</b>  127, 131	<b>1071</b>  197, 200, 207	<b>1072</b>  166, 200, 203, 204, 209, 213	<b>1073</b>  127, 142	<b>1074</b>  142
<b>1074-A</b>  127	<b>1075</b>  117, 119	<b>1076</b>  153, 213	<b>1077</b>  213	<b>1078</b>  35
<b>1079</b>  35, 66, 74	<b>1081</b>  100, 102	<b>1083</b>  214	<b>1084</b>  89	<b>1087</b>  240

# CONSECUTIVO

AUTOS Y CAMIONETAS



<p><b>1088</b></p> <p>240</p>	<p><b>1089</b></p> <p>117</p>	<p><b>1089-A</b></p> <p>119</p>	<p><b>1090</b></p> <p>117, 119</p>	<p><b>1091</b></p> <p>240</p>
<p><b>1092</b></p> <p>197</p>	<p><b>1093</b></p> <p>66</p>	<p><b>1094</b></p> <p>29, 30, 156</p>	<p><b>1095</b></p> <p>133</p>	<p><b>1096</b></p> <p>142, 144, 145, 185</p>
<p><b>1097</b></p> <p>29, 30, 156, 162, 163</p>	<p><b>1098</b></p> <p>29, 30, 156</p>	<p><b>1099</b></p> <p>29, 30, 156</p>	<p><b>1100</b></p> <p>29, 30, 156, 162, 163</p>	<p><b>1101</b></p> <p>31, 156</p>
<p><b>1103</b></p> <p>136, 137, 153</p>	<p><b>1104</b></p> <p>156</p>	<p><b>1105</b></p> <p>121, 123, 133</p>	<p><b>1106</b></p> <p>158</p>	<p><b>1107</b></p> <p>239, 244</p>
<p><b>1108</b></p> <p>131</p>	<p><b>1109</b></p> <p>30, 31</p>	<p><b>1110</b></p> <p>128, 178, 179</p>	<p><b>1111</b></p> <p>30, 31, 156</p>	<p><b>1112-A</b></p> <p>214</p>
<p><b>1113-A</b></p> <p>133</p>	<p><b>1114-A</b></p> <p>173, 174</p>	<p><b>1115-A</b></p> <p>81, 186, 187, 223, 224</p>	<p><b>1115-B</b></p> <p>187</p>	<p><b>1116-A</b></p> <p>131</p>
<p><b>1117-A</b></p> <p>133</p>	<p><b>1121-A</b></p> <p>209</p>	<p><b>1122-A</b></p> <p>75, 87, 169</p>	<p><b>1123-A</b></p> <p>30, 31, 156, 163</p>	<p><b>1125-A</b></p> <p>33, 243</p>



# CONSECUTIVO

AUTOS Y CAMIONETAS

<b>1127-A</b>  142	<b>1129-A</b>  198, 201, 203, 219	<b>1130-A</b>  152, 219	<b>1131-A</b>  79, 80, 85, 87	<b>1132-A</b>  204
<b>1133-A</b>  128, 178, 179	<b>1134-A</b>  128, 178, 179	<b>5042</b>  148, 149	<b>5186*</b>  126, 134	<b>5187*</b>  132
<b>5188</b>  217	<b>5192</b>  148, 149	<b>5193</b>  217	<b>5194</b>  82, 83	<b>5206</b>  75, 80, 82, 83
<b>A10</b>  94, 172, 175	<b>A103</b>  40, 94, 171, 175	<b>A103-C</b>  40, 94, 171, 175	<b>A104</b>  94, 175	<b>A105</b>  32, 221, 238, 242, 243
<b>A105-C</b>  32, 221, 238, 242, 243	<b>A199-262</b>  32, 221, 238, 241, 242, 243	<b>A199-262BC</b>  238	<b>A199-262-R</b>  238	<b>A199-555</b>  32, 221, 241
<b>A199-851</b>  32, 221, 241	<b>A206-C</b>  215	<b>A506-C</b>  92	<b>A806-C</b>  97, 99, 101, 103, 105	<b>A897</b>  33, 242
<b>A898</b>  33, 242	<b>A1172</b>  32, 221, 238, 242, 243	<b>A1272</b>  32, 221, 238, 242	<b>A1511</b>  215, 216, 217	<b>A1670</b>  220, 239, 244

# CONSECUTIVO

AUTOS Y CAMIONETAS

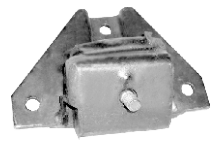

<b>A1774</b>  219	<b>A1789-B</b>  214	<b>A1792</b>  202, 218, 219	<b>A2183-A</b>  109	<b>A2185</b>  92
<b>A2267</b>  39	<b>A2283</b>  42, 68, 69	<b>A2331</b>  148, 152	<b>A2332</b>  148, 152	<b>A2364</b>  122, 139
<b>A2365</b>  122, 139	<b>A2367</b>  154	<b>A2368</b>  154	<b>A2370</b>  139	<b>A2371</b>  122, 139
<b>A2379</b>  37 38, 39, 42, 49, 60, 62, 65, 67	<b>A2381</b>  42, 86	<b>A2382</b>  37, 39 42, 49, 52, 57, 60, 62, 65, 67	<b>A2383</b>  38, 42, 52, 62, 65, 67	<b>A2384</b>  37, 39 42, 49, 52, 57, 60, 62, 65, 67
<b>A2387</b>  37, 52	<b>A2391</b>  42, 87	<b>A2393</b>  39, 52, 65, 75, 82, 83, 88	<b>A2400</b>  195, 198	<b>A2401</b>  206
<b>A2409</b>  227, 229, 230, 236	<b>A2410</b>  227, 229, 230, 234, 236	<b>A2437</b>  124, 130	<b>A2438</b>  124, 130	<b>A2439</b>  152
<b>A2440</b>  152	<b>A2446</b>  172	<b>A2474</b>  40	<b>A2500</b>  123, 130, 139	<b>A2501</b>  123, 130, 139



# CONSECUTIVO

AUTOS Y CAMIONETAS

<b>A2549</b>  39, 53, 75, 86, 88	<b>A2550</b>  39, 53, 75, 86, 88	<b>A2553</b>  37, 49, 50, 52, 53, 62	<b>A2555</b>  49, 50, 58, 63, 67	<b>A2556</b>  37, 38, 49, 50, 52, 53, 62, 69
<b>A2559</b>  124, 131, 138	<b>A2562</b>  85	<b>A2563</b>  85	<b>A2567</b>  85	<b>A2568</b>  37, 38, 49, 50, 52, 53, 62
<b>A2569</b>  171, 172, 175, 176	<b>A2570</b>  114, 171, 172, 175	<b>A2571</b>  171, 172, 175	<b>A2572</b>  171, 175, 176	
<b>A2601</b>  37, 38, 40, 45, 49, 57, 72	<b>A2609</b>  49, 58, 63, 69		<b>A2618</b>  99, 103, 106	<b>A2622</b>  136, 137
<b>A2623</b>  137	<b>A2625</b>  171, 172, 175	<b>A2626</b>  49, 72	<b>A2631</b>  150	<b>A2637</b>  75, 77, 79, 80
<b>A2638</b>  75, 76, 77, 78, 79, 80, 82, 83, 84, 85, 86, 87, 88, 89, 164, 169	<b>A2640</b>  142, 150, 187	<b>A2641</b>  142, 144, 145, 150, 184, 187	<b>A2642</b>  142, 150, 187	<b>A2643</b>  143, 144, 145, 150, 184, 187
<b>A2644</b>  151	<b>A2645</b>  151	<b>A2646</b>  151	<b>A2649</b>  125, 140, 182, 184	<b>A2650</b>  125, 140, 179, 182, 184



# CONSECUTIVO

AUTOS Y CAMIONETAS



MR

<b>A2664</b>  38, 52, 62	<b>A2668</b>  144	<b>A2674</b>  229	<b>A2676</b>  63	 MR
<b>A2677</b>  226, 227	<b>A2678</b>  ??	<b>A2685</b>  231, 232	<b>A2690</b>  227, 229, 230, 236	<b>A2698</b>  33, 62, 68, 76, 81, 150, 186
<b>A2707</b>  122, 134, 139	<b>A2711</b>  99 101, 103, 105, 106, 117, 119	<b>A2712</b>  49, 58, 60, 61, 63, 67, 69	<b>A2715</b>  34, 37, 40, 45, 57, 63, 72	<b>A2725</b>  123, 134, 139
<b>A2726</b>  123, 134, 139	<b>A2727</b>  148	<b>A2728</b>  148	<b>A2730</b>  115, 193, 194	<b>A2755</b>  75
<b>A2756</b>  75	<b>A2767</b>  152	<b>A2768</b>  152	<b>A2770</b>  137	<b>A2771</b>  76, 78, 86
<b>A2774</b>  185, 186	 MR	<b>A2775</b>  185, 186	<b>A2780</b>  50, 51, 70	<b>A2781</b>  50, 51, 70
<b>A2783</b>  40, 42, 44, 49, 50, 51, 72	<b>A2785</b>  150	<b>A2786</b>  150	<b>A2789HY</b>  136, 137	<b>A2790HY</b>  136, 137



# CONSECUTIVO

AUTOS Y CAMIONETAS

<b>A2794</b>  216, 217	<b>A2795</b>  96, 98, 99, 101, 110	<b>A2796HY</b>  42, 49, 58, 60, 63 67, 69, 73, 75, 77, 89, 90, 91	<b>A2797HY</b>  76, 78, 86, 110	<b>A2799</b>  49, 58, 67, 68, 69, 70
<b>A2800</b>  37, 38, 49, 50, 53, 62, 68	<b>A2801</b>  37, 62, 68, 69	<b>A2802</b>  76, 86	<b>A2806</b>  124, 130	<b>A2807</b>  124, 130
<b>A2807</b>  139	<b>A2808</b>  173, 174	<b>A2809</b>  173, 174	<b>A2818</b>  42, 58, 60 67, 69, 73, 75, 77, 89, 90, 91	<b>A2823HY</b>  37, 38, 57, 62, 68
 MR	 MR	<b>A2828</b>  173, 179,	<b>A2829</b>  111, 114, 116	<b>A2830</b>  116
<b>A2831</b>  148	<b>A2832</b>  143, 145, 148	<b>A2833</b>  148	<b>A2834</b>  148	<b>A2835</b>  143, 145, 148
<b>A2836</b>  50, 51, 70	<b>A2837HY</b>  50, 51	<b>A2838</b>  50, 51, 70	<b>A2848-A</b>  94, 100, 107	<b>A2848-C</b>  94, 100
<b>A2849-C</b>  117, 119	<b>A2851</b>  144, 145, 150	<b>A2853</b>  150, 187	<b>A2854</b>  153, 213	<b>A2855</b>  153, 197, 200, 213

# CONSECUTIVO

AUTOS Y CAMIONETAS



<b>A2856</b>  153, 213	<b>A2857</b>  153, 200, 213	<b>A2858</b>  111, 114, 176	<b>A2860</b>  130, 139	<b>A2861</b>  130, 139
<b>A2862</b>  136, 137	<b>A2863</b>  173	<b>A2864</b>  173	<b>A2866</b>  42, 58, 60, 61, 63, 67, 89, 91 34	<b>A2867</b>  100, 102, 107
<b>A2868</b>  144, 145	<b>A2872</b>  40	<b>A2874</b>  49, 57, 64, 65	<b>A2880</b>  39, 53, 88	<b>A2881</b>  37, 38, 62, 68, 69
<b>A2883</b>  176	<b>A2885</b>  121, 123, 133	<b>A2885-C</b>  121, 133	<b>A2886-C</b>  121, 133	<b>A2887</b>  121, 133
<b>A2887-C</b>  121, 133	<b>A2899</b>  60, 61, 67, 73, 75, 89, 90, 91	<b>A2900</b>  75, 77, 89, 90, 91	<b>A2901</b>  42, 49, 58, 60, 63, 67, 69	<b>A2903HY</b>  92, 96, 98
<b>A2908</b>  96, 98, 99	<b>A2912</b>  125, 140, 182, 184	<b>A2915</b>  153	<b>A2925</b>  117, 119	<b>A2928</b>  117, 119
<b>A2929</b>  143, 152	<b>A2930</b>  143, 152	<b>A2931</b>  153	<b>A2939</b>  127, 128	<b>A2940</b>  150



# CONSECUTIVO

AUTOS Y CAMIONETAS

<b>A2941</b>  150	<b>A2945</b>  94, 95, 96, 104, 106, 107, 108	 MR	<b>A2947</b>  100, 102	<b>A2948</b>  100, 102
<b>A2949</b>  100, 102	<b>A2954</b>  114	<b>A2956</b>  78, 86, 169	<b>A2957</b>  78, 86, 169	<b>A2958</b>  94, 95, 96, 104, 106, 107, 108
<b>A2959</b>  117, 119	<b>A2960</b>  118	<b>A2968HY</b>  137	<b>A2972</b>  143, 145, 148	<b>A2975</b>  100, 102
<b>A2975-R</b>  100, 102	<b>A2977</b>  153	<b>A2978</b>  121, 123, 133	<b>A2979</b>  94, 100, 107	<b>A2984</b>  118, 119
<b>A2989</b>  153, 213	<b>A2991</b>  114	<b>A2995</b>  123, 139	<b>A2996</b>  136, 137	<b>A2997</b>  134
<b>A2998</b>  134	<b>A3037</b>  142, 144, 145, 185	<b>A3057</b>  142, 144, 145, 185	<b>A3101</b>  179	<b>A3105</b>  129
<b>A3107</b>  129, 131, 179	<b>A3108</b>  129	<b>A3108-R</b>  129	<b>A3109</b>  184	<b>A3904</b>  179

# CONSECUTIVO

AUTOS Y CAMIONETAS



<p><b>A3905</b></p>  <p>129</p>	<p><b>A3906</b></p>  <p>129</p>	<p><b>A3907</b></p>  <p>129</p>	<p><b>A3908</b></p>  <p>129</p>	<p><b>A3910</b></p>  <p>129</p>
<p><b>A3911</b></p>  <p>149</p>	<p><b>A3912</b></p>  <p>129</p>	<p><b>A4089</b></p>  <p>218</p>	<p><b>A4309</b></p>  <p>218</p>	<p><b>A4378</b></p>  <p>35, 74</p>
<p><b>A4380</b></p>  <p>35, 44, 74</p>	<p><b>A4381</b></p>  <p>35, 74</p>	<p><b>A4381-A</b></p>  <p>35, 74</p>	<p><b>A5209</b></p>  <p>121, 133</p>	<p><b>A5217</b></p>  <p>124</p>
<p><b>A5218</b></p>  <p>124</p>	<p><b>A5260</b></p>  <p>100, 102</p>	<p><b>A5261-R</b></p>  <p>100, 102</p>	<p><b>A5243</b></p>  <p>136, 137</p>	<p><b>A6341</b></p>  <p>200</p>
<p><b>A7286</b></p>  <p>219</p>	<p><b>A7311</b></p>  <p>204</p>	<p><b>A8007</b></p>  <p>158</p>	<p><b>A8009</b></p>  <p>29, 156</p>	<p><b>A8016</b></p>  <p>156</p>
<p><b>A8019</b></p>  <p>156</p>	<p><b>A8020</b></p>  <p>128</p>	 <p>MR</p>	<p><b>A8026</b></p>  <p>29, 156</p>	<p><b>A8049</b></p>  <p>168</p>
<p><b>A8051</b></p>  <p>167</p>	<p><b>A8052</b></p>  <p>168</p>	<p><b>A8053</b></p>  <p>168</p>	<p><b>A8054</b></p>  <p>168</p>	<p><b>A8069</b></p>  <p>180</p>



# CONSECUTIVO

AUTOS Y CAMIONETAS

<b>A8073</b>  135, 180, 183	<b>A8074</b>  135, 156, 163, 171, 180, 183	<b>A8084</b>  186	<b>A8087</b>  135	<b>A8095</b>  186, 187
<b>A8099</b>  190, 193	<b>A8103</b>  190, 193	<b>A8111</b>  194	<b>A8112</b>  190	<b>A8114</b>  208, 211
<b>A8122</b>  195, 202, 203, 206	<b>A8124</b>  208, 210, 211	<b>A8137</b>  200	<b>A8140</b>  200	<b>A8161</b>  223
<b>A8165</b>  234, 236	<b>A8173</b>  232	<b>A8177</b>  55, 229	<b>A8178</b>  55, 229	<b>A8179</b>  55, 229
<b>A8180</b>  55, 229	<b>A8181</b>  55, 229	<b>A8186</b>  229	<b>A8192</b>  226	<b>A8193</b>  226, 227
<b>A8196</b>  226	<b>A8199</b>  226, 232	<b>A8207</b>  226	<b>A8208</b>  177, 226	<b>A8214</b>  229
<b>A8278</b>  232	<b>A8296</b>  196	<b>A8311</b>  166, 208, 210	<b>A8344</b>  30, 156, 230	<b>A8347</b>  29, 156, 160, 163, 170

# CONSECUTIVO

AUTOS Y CAMIONETAS



<p><b>A8404</b></p> <p>29</p>	<p><b>A8407</b></p> <p>227</p>	<p><b>A8411</b></p> <p>158, 159</p>	<p><b>A8432</b></p> <p>29, 156, 163, 171</p>	<p><b>A8516</b></p> <p>135, 180, 183</p>
<p><b>A8529</b></p> <p>177, 226, 232</p>	<p><b>A8568</b></p> <p>81, 222, 223, 224</p>	<p><b>A8569</b></p> <p>81</p>	<p><b>A8576</b></p> <p>170</p>	<p><b>A8577</b></p> <p>170</p>
<p><b>A8579</b></p> <p>170</p>	<p><b>A8601</b></p> <p>200</p>	<p><b>A8603</b></p> <p>200</p>	<p><b>A8604</b></p> <p>200</p>	<p><b>A8614-A</b></p> <p>30, 156, 158, 160</p>
<p><b>A8615</b></p> <p>156</p>	<p><b>A8662HY</b></p> <p>188, 189</p>	<p><b>A8663HY</b></p> <p>33</p>	<p><b>A8690</b></p> <p>221</p>	<p><b>A8691</b></p> <p>134, 180, 183</p>
<p><b>A8699</b></p> <p>225, 232, 237</p>	<p><b>A8701</b></p> <p>195</p>	<p><b>A8704</b></p> <p>197</p>	<p><b>A8705</b></p> <p>197, 200, 203, 207, 213</p>	<p><b>A8792</b></p> <p>192</p>
<p><b>A8793</b></p> <p>110, 190, 191</p>	<p><b>A8796HY</b></p> <p>226</p>	<p><b>A8798</b></p> <p>107, 190, 192</p>	<p><b>A8810</b></p> <p>196</p>	<p><b>A8819</b></p> <p>193</p>
<p><b>A8823</b></p> <p>30</p>	<p><b>A8845</b></p> <p>156</p>	<p><b>A8865</b></p> <p>166, 197, 200</p>	<p><b>A8866</b></p> <p>166, 197, 200</p>	<p><b>A8870</b></p> <p>85, 167, 168, 170</p>



# CONSECUTIVO

AUTOS Y CAMIONETAS

<b>A8874</b>  204, 212	<b>A8899</b>  156, 226	<b>A8962</b>  200	<b>A8971</b>  156	<b>A8973</b>  161, 162
 MR	<b>A8974</b>  29, 30, 31, 156, 162, 163	<b>A8975</b>  158	<b>A8979</b>  226, 232	<b>A8982</b>  161
<b>A8983</b>  156, 161	<b>A8984</b>  29, 156, 163, 171	<b>A8995</b>  177, 221, 225	<b>A9012</b>  208, 210	<b>A9016</b>  158
<b>A9031</b>  166, 200	<b>A9035</b>  166, 200	 MR	<b>A9037</b>  132, 193	<b>A9038</b>  166, 208
<b>A9044</b>  196	<b>A9048</b>  200	<b>A9053</b>  226	<b>A9058</b>  190, 191	<b>A9059</b>  193
<b>A9066</b>  161, 162	<b>A9087</b>  135, 180, 183	<b>A9139</b>  161	<b>A9142</b>  32, 143, 148, 162, 168, 169	<b>A9143</b>  143, 148., 149, 167, 168, 170
<b>A9144</b>  162	<b>A9156</b>  222	<b>A9160</b>  107, 165, 190, 192	<b>A9161</b>  190, 191	<b>A9168</b>  161



# CONSECUTIVO

AUTOS Y CAMIONETAS



<b>A9174</b>  194	<b>A9175</b>  30, 158	 MR	<b>A9177</b>  222	<b>A9184</b>  107, 190
<b>A9187</b>  104, 110, 190, 192	<b>A9188</b>  192	<b>A9189</b>  191	<b>A9190</b>  197, 200, 207, 213	<b>A9193</b>  190
<b>A9195</b>  179	<b>A9330</b>  45	<b>A9671</b>  204	<b>A9771</b>  198, 201, 204	<b>A5085476AC</b>  93, 95, 104, 112
<b>A83692-5Z001</b>  198, 201, 203, 204	<b>B200-A</b>  83	<b>B200-B</b>  83	 MR	 MR
 MR	 MR	 MR	 MR	 MR

# ESPECIALES

MULTIUSOS

<b>261</b> 	<b>261-A</b> 	<b>261-B</b> 	<b>377</b> 	<b>378</b> 
----------------	------------------	------------------	----------------	----------------

Autopartes Hule - Metal



# BUFALO AHM

---

## CATÁLOGO *Dosmil12*



MR

**SOPORTES AUTOMOTRICES  
POR LINEA**

**AUTOMÓVILES  
CAMIONETAS**

---

SECCIÓN II



# DIAGRAMACIÓN

SOPORTES

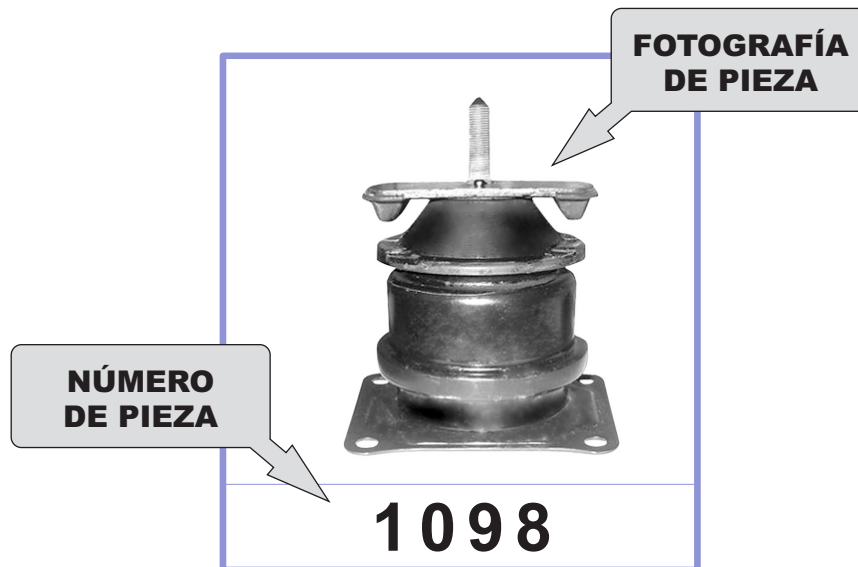

**NOTA: TODAS LAS FOTOGRAFÍAS USADAS TIENEN UN FIN ILUSTRATIVO Y NO CORRESPONDEN AL TAMAÑO ORIGINAL. ( PARA MAYORES INFORMES ACERCA DE CUALQUIER PRODUCTO, CONSULTE A SU DISTRIBUIDOR AUTORIZADO)**

CL	MOTOR	MODELO	SOPORTE	ESPECIFICACIÓN	No. BUFALO
L4	2.2	97 - 99	MOTOR	FRONT / STD	<b>A8026</b>
			MOTOR	FRONT / AUT	<b>A8432</b>
			MOTOR	FRONT / IZQ	<b>A8404</b>
			MOTOR	TRAS / AUT / VÁLVULA SELENOIDE	<b>A8984</b>
	2.3		MOTOR	TRAS / AUT / SIN VÁLVULA SELENOIDE	PRÓXIMAMENTE
			MOTOR	STD	<b>A8009</b>
			TRANSMISIÓN	AUT	<b>A8347</b>
			TRANSMISIÓN	STD	<b>A8347</b>

V6	3.2	01 - 03	MOTOR	FRONT	<b>1099</b>
			MOTOR	FRONT / DER / REPUESTO A8974	<b>1094</b>
			MOTOR	FRONT / DER	<b>A8974</b>
			MOTOR	TRAS	<b>1098</b>
			TRANSMISIÓN	FRONT	<b>1100</b>
			TRANSMISIÓN	TRAS	<b>1097</b>

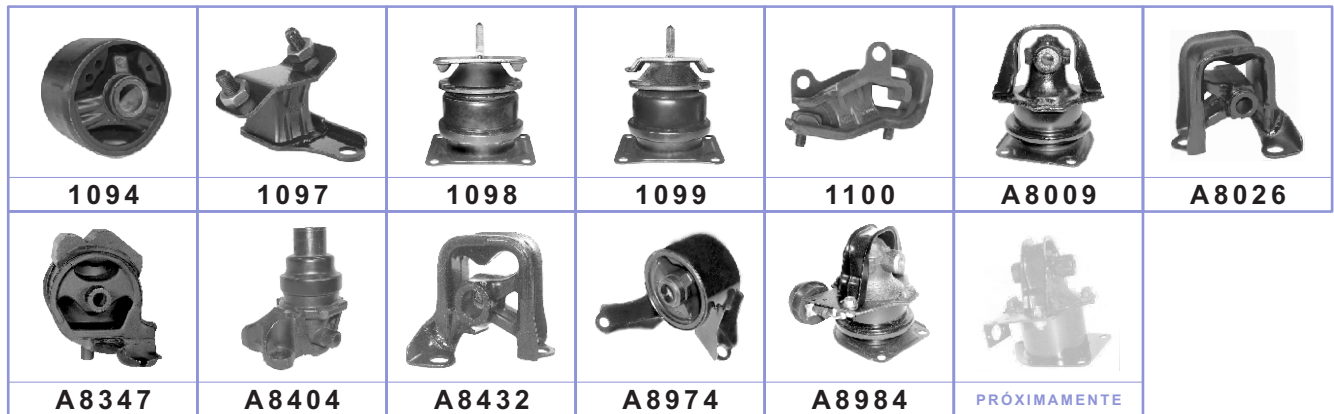

INTEGRA	MOTOR	MODELO	SOPORTE	ESPECIFICACIÓN	No. BUFALO
L4	1.8	94 - 01	MOTOR	FRONT / STD	<b>973</b>
			MOTOR	FRONT / AUT	<b>973</b>
			MOTOR	FRONT / INF / IZQ / STD / TIPO "R"	<b>974</b>
			MOTOR	FRONT / INF / IZQ / STD / AUT / EXCEPTO TIPO "R"	<b>974</b>
			MOTOR	TRAS	<b>993</b>
			TRANSMISIÓN		<b>994</b>
	90 - 01	TRANSMISIÓN	STD	PRÓXIMAMENTE	





# ACURA

**AUTOS**

LEGEND	MOTOR	MODELO	SOPORTE	ESPECIFICACIÓN	No. BUFALO
V6	2.5	87 - 88	MOTOR	TRAS	A8344
	2.7	86 - 90	MOTOR	REP / TRAS / SOPORTE TORSIÓN	A8614-A

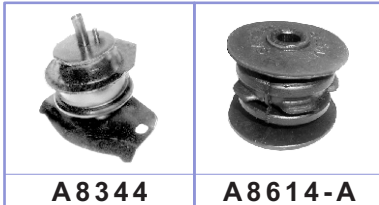

RSX	MOTOR	MODELO	SOPORTE	ESPECIFICACIÓN	No. BUFALO
		90 - 93	MOTOR	REP / TRAS / SOPORTE TORSIÓN	A8823
		02 - 06	TRANSMISIÓN		A9175

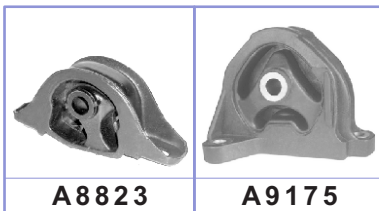

TL	MOTOR	MODELO	SOPORTE	ESPECIFICACIÓN	No. BUFALO
V6	3.2	99 - 03	MOTOR	FRONT	1099
		96 - 98	MOTOR	FRONT / DER	A8974
		99 - 03	MOTOR	TRAS	1098
			TRANSMISIÓN	TRAS	1097
			TRANSMISIÓN	FRONT / IZQ	1100
V6	3.5	06 - 08	MOTOR	FRONT	1123-A
			MOTOR	FRONT / DER	1109
			MOTOR	TRAS	1111

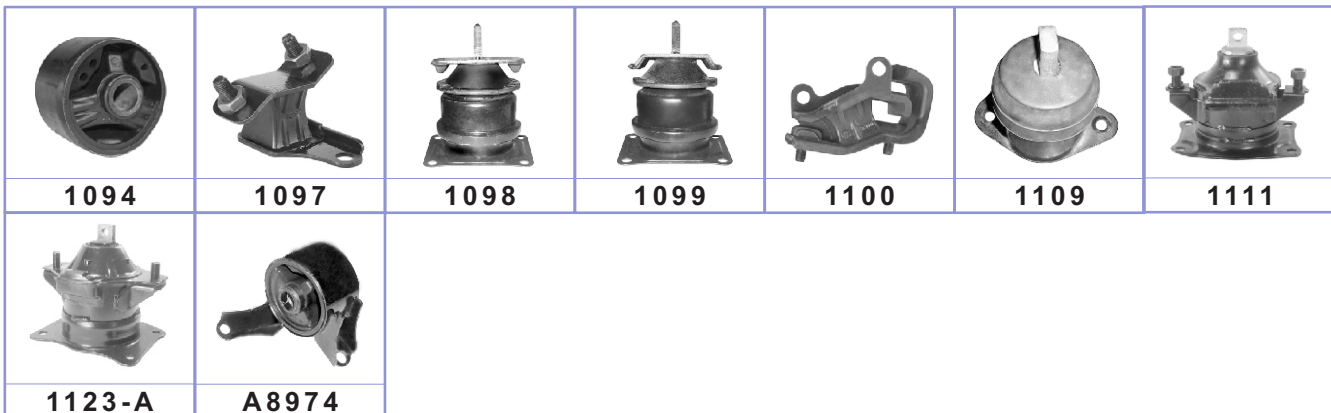

# ACURA

**AUTOS**



TSX	MOTOR	MODELO	SOPORTE	ESPECIFICACIÓN	No. BUFALO
L4 2.4	03 - 07	MOTOR	FRONT	1123-A	
		MOTOR	FRONT / DER / AUT	1109	
		MOTOR	TRAS / AUT	1111	
		TRANSMISIÓN	FRONT / INF	PRÓXIMAMENTE	
		TRANSMISIÓN	TRAS / INF / AUT	1101	
		TRANSMISIÓN	CENTRAL	PRÓXIMAMENTE	

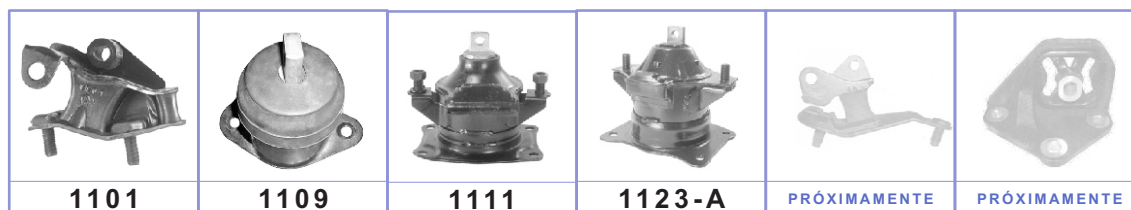

# ACURA

**TODOS TERRENO**

MDX	MOTOR	MODELO	SOPORTE	ESPECIFICACIÓN	No. BUFALO
L4 2.4	03 - 07	MOTOR	FRONT	1123-A	
		MOTOR	FRONT / DER / AUT	1109	
		MOTOR	TRAS / AUT	A9194	
		TRANSMISIÓN	CENTRAL	PRÓXIMAMENTE	
		TRANSMISIÓN	FRONT / INF	PRÓXIMAMENTE	
		TRANSMISIÓN	TRAS / INF / AUT	1101	
V6 3.5	01 - 02	MOTOR	FRONT / DER	A8974	
		TRANSMISIÓN	FRONT	1100	
		TRANSMISIÓN	TRAS	1097	
	01 - 06	MOTOR	FRONT	PRÓXIMAMENTE	
		MOTOR	TRAS	PRÓXIMAMENTE	
	03 - 06	TRANSMISIÓN	FRONT	PRÓXIMAMENTE	
TRANSMISIÓN		TRAS	PRÓXIMAMENTE		





# ACURA

**TODO TERRENO**

SLX					No. BUFALO
V6	3.2	96 - 99	MOTOR	FRONT / IZQ	PRÓXIMAMENTE
			MOTOR	FRONT / DER	PRÓXIMAMENTE
	3.5		TRANSMISIÓN		<b>A9142</b>



# AUDI

**AUTOS**

A3	MOTOR	MODELO	SOPORTE	ESPECIFICACIÓN	No. BUFALO
L4	1.8	97 - 01	MOTOR	FRONT / DER	<b>A199-262</b>
			MOTOR	TRAS	<b>A199-851</b>
	2.0		TRANSMISIÓN		<b>A199-555</b>
L4	2.0	06 - 09	MOTOR	FRONT / DER	<b>A199-262</b>
			MOTOR	CENTRAL SUP	PRÓXIMAMENTE
			MOTOR	CENTRAL INF	PRÓXIMAMENTE
			MOTOR	TORSIÓN CENTRAL	<b>A105-C</b>
			TRANSMISIÓN	AUT	<b>A1172</b>
			TRANSMISIÓN	STD	<b>A1272</b>

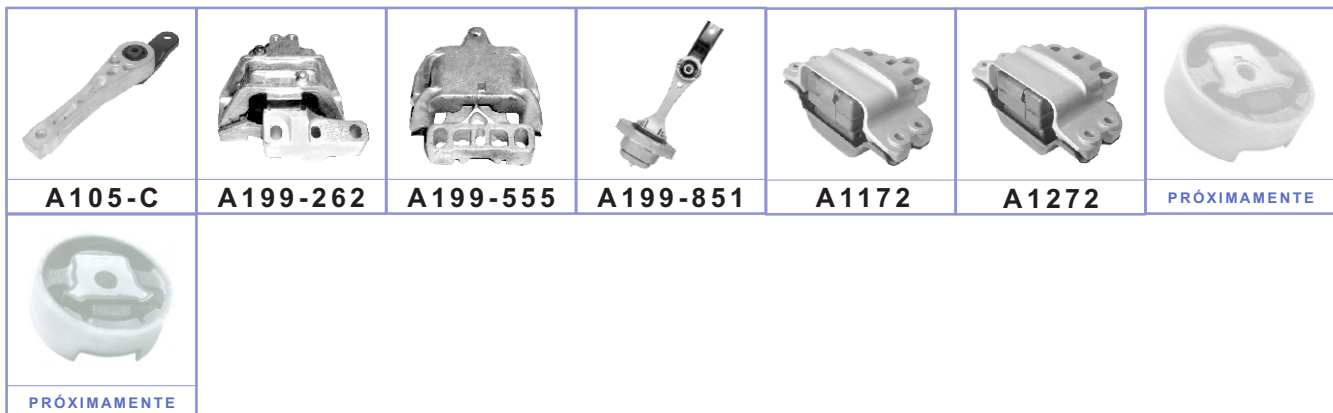

A4 / QUATTRO	MOTOR	MODELO	SOPORTE	ESPECIFICACIÓN	No. BUFALO
L4	1.8	97 - 03	MOTOR	FRONT / IZQ	<b>A897</b>
			MOTOR	FRONT / DER	<b>A898</b>
			MOTOR	FRONT / IZQ / TURBO	<b>A897</b>
			TRANSMISIÓN	DER / IZQ / AUT	PRÓXIMAMENTE
			TRANSMISIÓN	DER / IZQ / STD	<b>1125-A</b>

CONTINÚA...



# AUDI

AUTOS



<b>A4 / QUATTRO</b>	L5	2.2	85 - 92	MOTOR	QUATTRO / DER / IZQ	<b>A8663HY</b>
	V6	2.8 3.0	96 - 04	MOTOR	FRONT / DER / IZQ	<b>A897</b>
				TRANSMISIÓN	DER / IZQ	<b>1125-A</b>



<b>A6</b>	MOTOR	MODELO	SOPORTE	ESPECIFICACIÓN	<i>No. BUFALO</i>
V6	2.8	98 - 01	MOTOR	DER / IZQ	<b>A897</b>
		98 - 99	TRANSMISIÓN	DER / IZQ	<b>1125-A</b>
V6	3.0	00 - 04	MOTOR	FRONT / DER / IZQ	<b>A897</b>
			TRANSMISIÓN		<b>1125-A</b>

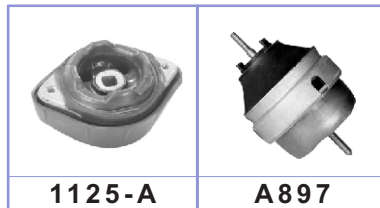

# BMW

AUTOS

<b>M5, M6 525 SERIE 533i, 535i 633csi, 635csi</b>	MOTOR	MODELO	SOPORTE	ESPECIFICACIÓN	<i>No. BUFALO</i>
	L6	2.5	91 - 95	MOTOR	FRONT / DER / IZQ





# CHEVROLET

**AUTOS**

ACHIEVA	MOTOR	MODELO	SOPORTE	ESPECIFICACIÓN	No. BUFALO
"OLDSMOBILE"	L4 2.3	92 - 94	MOTOR	TORSIÓN FRONT	983 - A
			TRANSMISIÓN	FRONT / IZQ / STD / 5 VEL	936
		92 - 95	MOTOR	FRONT / DER	931
			TRANSMISIÓN	AUT	981
			TRANSMISIÓN	AUT	A2715
		95	MOTOR	TORSIÓN FRONT	983
L4 2.4	96 - 98	MOTOR	FRONT / DER / STD	931	
		MOTOR	TORSIÓN FRONT / AUT	983 - A	
		MOTOR	TORSIÓN FRONT	983	
		TRANSMISIÓN	AUT	981	
		TRANSMISIÓN	AUT	A2715	
V6 3.1	94 - 98	94	MOTOR	TORSIÓN FRONT	983 - A
		MOTOR	FRONT / DER	931	
		TRANSMISIÓN	AUT	981	
		TRANSMISIÓN	AUT	A2715	
		95 - 98	MOTOR	TORSIÓN FRONT	983
V6 3.3	92 - 93	MOTOR	FRONTAL / DER	931	
		MOTOR	TORSIÓN FRONTAL	983 - A	
		TRANSMISIÓN		981	
		TRANSMISIÓN		A2715	

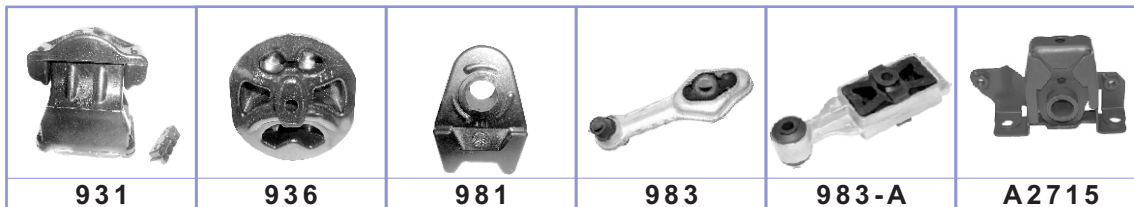

ALLURE	MOTOR	MODELO	SOPORTE	ESPECIFICACIÓN	No. BUFALO
"BUICK"	V8 5.3	08	MOTOR	FRONTAL	PRÓXIMAMENTE
			MOTOR	FRONTAL / DER / IZQ / BRACKET RADIADOR	PRÓXIMAMENTE
			MOTOR	TORSIÓN FRONTAL / DER / IZQ	A2866
			TRANSMISIÓN		PRÓXIMAMENTE

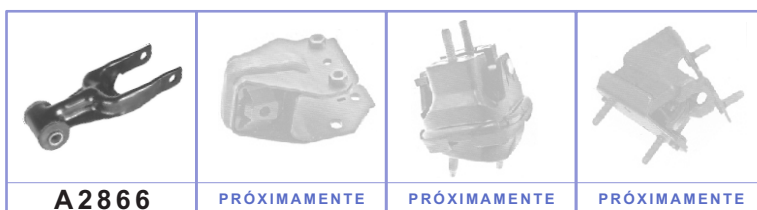

ASTRA	MOTOR	MODELO	SOPORTE	ESPECIFICACIÓN	No. BUFALO
L4	1.8	00 - 09	MOTOR	FRONTAL / DER / IZQ / REPUESTO	<b>1006</b>
			MOTOR	FRONTAL / AUT / REPUESTO	<b>1007</b>
			MOTOR	FRONTAL / AUT	PRÓXIMAMENTE
			MOTOR	FRONTAL / DER / STD	<b>A4378</b>
			MOTOR	DER / IZQ	<b>1079</b>
			TRANSMISIÓN	FRONTAL / INF	<b>A4380</b>
			TRANSMISIÓN	FRONTAL / INF / REPUESTO A4380	<b>1078</b>
			TRANSMISIÓN	TRASERO	<b>1016</b>

L4	2.2	00 - 09	MOTOR	FRONTAL / AUT	<b>1007</b>
			MOTOR	FRONTAL / AUT	PRÓXIMAMENTE
			MOTOR	FRONTAL / DER / EDICIÓN ESPECIAL	PRÓXIMAMENTE
			TRANSMISIÓN	FRONTAL / INF / STD	<b>A4381-A</b>
			TRANSMISIÓN	DER / STD / AUT	<b>A4381</b>
			TRANSMISIÓN	STD / AUT / REPUESTO A4381	<b>1005</b>
			TRANSMISIÓN	EDICIÓN ESPECIAL	PRÓXIMAMENTE

L4	2.0 2.4	04 - 09	MOTOR	FRONTAL / DER / AUT / REPUESTO 1214	<b>1007</b>
			MOTOR	FRONTAL / DER / AUT	PRÓXIMAMENTE
			MOTOR	FRONTAL / DER / STD	<b>A4378</b>
			TRANSMISIÓN	FRONTAL / INF / STD	<b>A4380</b>
			TRANSMISIÓN	FRONTAL / INF / AUT	<b>A4381-A</b>
			TRANSMISIÓN	TRASERO	<b>1016</b>
			TRANSMISIÓN	TRASERO	<b>1014</b>
			TRANSMISIÓN	TRASERO / REPUESTO 1014	<b>1005</b>

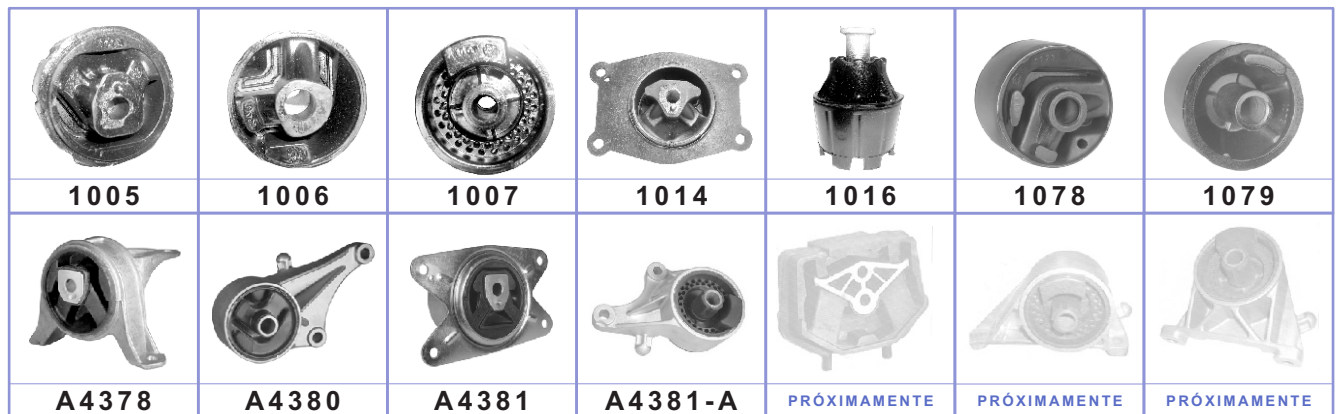





AVEO	MOTOR	MODELO	SOPORTE	ESPECIFICACIÓN	No. BUFALO
L4	1.6	08 - 10	MOTOR	FRONTAL / DER	PRÓXIMAMENTE
			MOTOR	FRONTAL / DER / REPUESTO 1624	PRÓXIMAMENTE
			MOTOR	TRASERO	PRÓXIMAMENTE
			TRANSMISIÓN		PRÓXIMAMENTE
			TRANSMISIÓN	REPUESTO 1626	PRÓXIMAMENTE

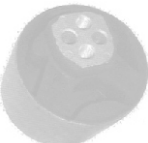

# CHEVROLET

**AUTOS**

<b>AVEO</b>					
	PRÓXIMAMENTE	PRÓXIMAMENTE	PRÓXIMAMENTE	PRÓXIMAMENTE	PRÓXIMAMENTE

<b>BERETTA</b>	MOTOR	MODELO	SOPORTE	ESPECIFICACIÓN	No. BUFALO
<b>L4</b>	2.0	<b>87 - 91</b>	MOTOR	FRONTAL / DER	<b>890</b>
			TRANSMISIÓN	DER	<b>899</b>
			TRANSMISIÓN	TORSIÓN	<b>882</b>
			TRANSMISIÓN		<b>A2601</b>
			TRANSMISIÓN	REPUESTO 6655	<b>866</b>
	2.2	<b>92 - 94</b>	MOTOR	TORSIÓN / FRONTAL	<b>983 - A</b>
			MOTOR	FRONTAL / DER	<b>931</b>
		<b>92 - 96</b>	TRANSMISIÓN		<b>A2715</b>
			TRANSMISIÓN	REPUESTO A2715	<b>981</b>
			MOTOR	TORSIÓN / FRONTAL	<b>983 - A</b>



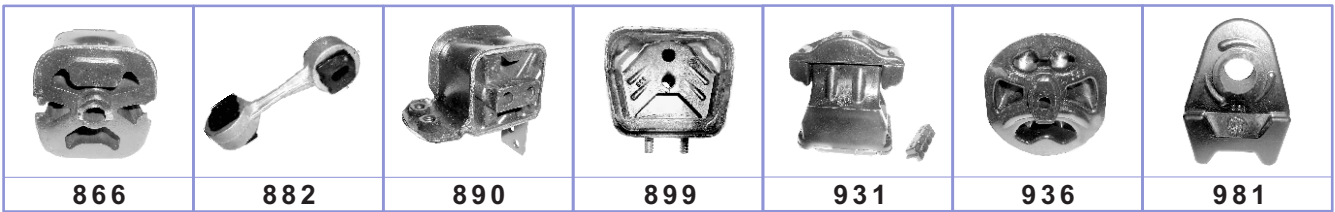

<b>L4</b>	2.3	<b>90 - 91</b>	MOTOR	FRONTAL / DER	<b>PRÓXIMAMENTE</b>
			MOTOR	TORSIÓN / FRONTAL	<b>882</b>
			TRANSMISIÓN		<b>936</b>
	<b>92 - 94</b>	MOTOR	FRONTAL / DER	<b>931</b>	
		MOTOR	TORSIÓN / FRONTAL	<b>983 - A</b>	

<b>L4</b>	2.8	<b>87 - 91</b>	MOTOR	FRONTAL / DER	<b>890</b>
			MOTOR	TRASERO / DER	<b>899</b>
			MOTOR	TORSIÓN / TRASERO	<b>882</b>
	3.1		MOTOR	TORSIÓN / TRASERO / LATERAL / APLICA MOTOR 2.8	<b>PRÓXIMAMENTE</b>
			TRANSMISIÓN		<b>A2601</b>
			TRANSMISIÓN	REPUESTO A2601	<b>866</b>



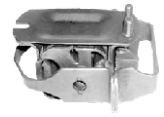









<b>V6</b>	3.1	<b>92 - 94</b>	MOTOR	TORSIÓN / FRONTAL	<b>983 - A</b>
		<b>92 - 95</b>	TRANSMISIÓN	FRONTAL / IZQ	<b>936</b>
		<b>92 - 96</b>	MOTOR	FRONTAL / DER	<b>931</b>
			TRANSMISIÓN		<b>A2715</b>
			TRANSMISIÓN	REPUESTO A2715	<b>981</b>
		<b>95 - 96</b>	MOTOR	TORSIÓN / FRONTAL	<b>983 - A</b>

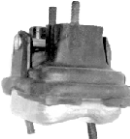

CONTINÚA...

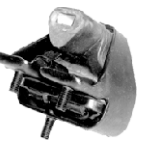
<b>BERETTA</b>					
	<b>983-A</b>	<b>A2601</b>	<b>A2715</b>	PRÓXIMAMENTE	PRÓXIMAMENTE

<b>BONEVILLE</b> "PONTIAC"	MOTOR	MODELO	SOPORTE	ESPECIFICACIÓN	No. <i>BUFALO</i>
V6 3.8	80 - 86		MOTOR	FRONTAL / IZQ	<b>A2382</b>
			MOTOR	FRONTAL / DER	<b>A2384</b>
			TRANSMISIÓN		<b>A2379</b>
	87 - 91		MOTOR	DER / IZQ	<b>A2553</b>
			TRANSMISIÓN	FRONTAL / IZQ	<b>804</b>
			TRANSMISIÓN	TRASERO / IZQ	<b>A2568</b>
			TRANSMISIÓN	TRASERO / DER	<b>A2556</b>
	92 - 93		TRANSMISIÓN	FRONTAL / IZQ	<b>A2800</b>
			TRANSMISIÓN	TRASERO / IZQ	<b>A2823HY</b>
	92 - 99		MOTOR	FRONTAL / DER	<b>A2801</b>
			MOTOR	TORSIÓN / FRONTAL	<b>794</b>
				TORSIÓN / FRONTAL / <i>REPUESTO 794</i>	<b>794-R</b>
	94 - 99		TRANSMISIÓN	FRONTAL / IZQ	<b>A2881</b>
			TRANSMISIÓN	TRASERO / IZQ	<b>A2568</b>
	00 - 03		TRANSMISIÓN	CENTRAL	PRÓXIMAMENTE
00 - 05		TRANSMISIÓN	TRASERO / IZQ	PRÓXIMAMENTE	
V8 4.3			MOTOR	FRONT / DER / IZQ	<b>A2387</b>

						
<b>794</b>	<b>794-R</b>	<b>804</b>	<b>A2379</b>	<b>A2382</b>	<b>A2384</b>	<b>A2387</b>
						
<b>A2553</b>	<b>A2556</b>	<b>A2568</b>	<b>A2800</b>	<b>A2801</b>	<b>A2823HY</b>	<b>A2881</b>
						
PRÓXIMAMENTE	PRÓXIMAMENTE					



# CHEVROLET

**AUTOS**

BUICK	MOTOR	MODELO	SOPORTE	ESPECIFICACIÓN	No. BUFALO
V6	3.0	75 - 88	TRANSMISIÓN		<b>A2379</b>
			MOTOR	DER	<b>A2383</b>
		83 - 94	TRANSMISIÓN	AUT / STD	<b>A2601</b>
		85 - 86	TRANSMISIÓN	TRASERO / DER	<b>A2664</b>
		85 - 91	TRANSMISIÓN	DER	<b>A2556</b>
			MOTOR		<b>A2626</b>
85 - 93	TRANSMISIÓN	IZQ	<b>A2568</b>		
V6	3.3	87 - 04	TRANSMISIÓN	TRASERO / IZQ	<b>A2823HY</b>
		92 - 93	TRANSMISIÓN		<b>A2800</b>
	3.8	94 - 99	TRANSMISIÓN	FRONTAL	<b>A2881</b>

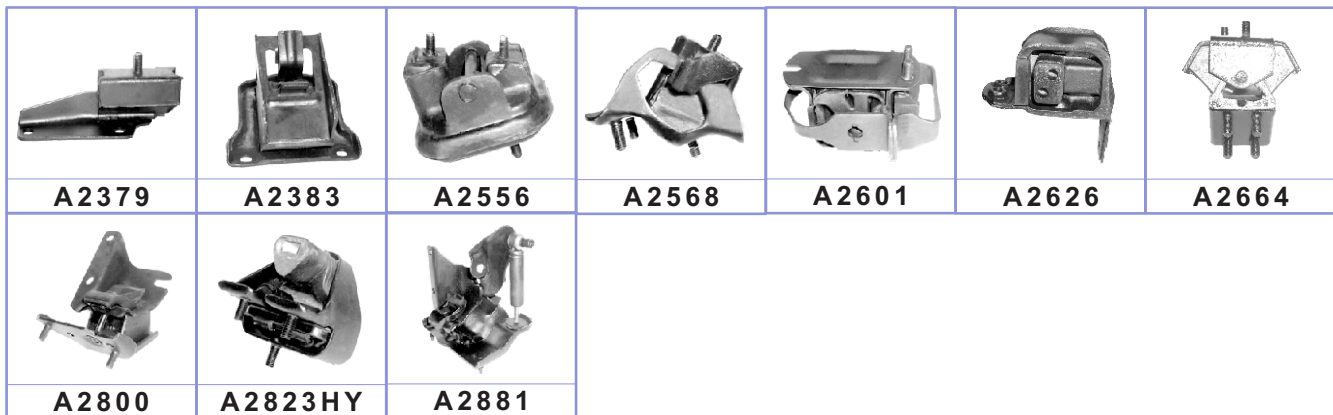

CAMARO	MOTOR	MODELO	SOPORTE	ESPECIFICACIÓN	No. BUFALO
L4	2.5	82 - 86	MOTOR	FRONTAL / IZQ	<b>A2549</b>
			MOTOR	FRONTAL / DER	<b>A2550</b>
			TRANSMISIÓN	STD / 5 VEL	<b>A2393</b>
			TRANSMISIÓN	STD / 4 VEL / AUT	<b>898</b>
V6	2.8	68 - 70	MOTOR	DER / IZQ	<b>A2267</b>
			MOTOR	FRONTAL / DER / IZQ	<b>919</b>
	3.1	82 - 86	TRANSMISIÓN		<b>930</b>
V6	3.4	93 - 95	MOTOR	FRONTAL / DER / IZQ	<b>919</b>
			TRANSMISIÓN		<b>A2880HY</b>
V6	3.8	81 / 91 - 02	MOTOR	FRONTAL / DER / IZQ	<b>919</b>
			MOTOR	FRONTAL / IZQ	<b>A2382</b>
			MOTOR	FRONTAL / DER	<b>A2384</b>
		80 - 81	TRANSMISIÓN		<b>A2379</b>
			TRANSMISIÓN		<b>930</b>
		95 - 02	TRANSMISIÓN		<b>PRÓXIMAMENTE</b>
			TRANSMISIÓN		<b>A2880HY</b>

CONTINÚA...

<b>CAMARO</b>						
	<b>898</b>	<b>919</b>	<b>930</b>	<b>A2267</b>	<b>A2379</b>	<b>A2382</b>
<b>A2384</b>	<b>A2393</b>	<b>A2549</b>	<b>A2550</b>	<b>A2880HY</b>	<b>PRÓXIMAMENTE</b>	

<b>CAPRICE</b>	MOTOR	MODELO	SOPORTE	ESPECIFICACIÓN	No. <b>BUFALO</b>
	V8 305	73 - 83	TRANSMISIÓN		<b>711</b>



<b>CAVALIER</b>	MOTOR	MODELO	SOPORTE	ESPECIFICACIÓN	No. <b>BUFALO</b>	
<b>L4</b>	1.8 2.0	<b>82 - 86</b>	MOTOR	FRONTAL / DER / STD / AIRE ACONDICIONADO	<b>PRÓXIMAMENTE</b>	
			MOTOR	TRASERO / DER	<b>899</b>	
		<b>82 - 89</b>	MOTOR	TORSIÓN / TRASERO	<b>882</b>	
			MOTOR	TORSIÓN / TRASERO	<b>PRÓXIMAMENTE</b>	
			TRANSMISIÓN	AUT / STD	<b>A2601</b>	
		TRANSMISIÓN	AUT / STD / REPUESTO A2601	<b>866</b>		
	<b>85 - 89</b>	MOTOR	FRONTAL / DER / MOT. 2.0 / AUT	<b>890</b>		
		MOTOR	FRONTAL / DER / MOT. 2.0 / STD	<b>890-A</b>		
	<b>L4</b>	2.2	<b>90 - 94</b>	MOTOR	FRONTAL / DER / STD	<b>890-A</b>
				MOTOR	TRASERO / DER	<b>899</b>
MOTOR				TORSIÓN / TRASERO	<b>882</b>	
TRANSMISIÓN				AUT / STD	<b>A2601</b>	
TRANSMISIÓN				AUT / STD / REPUESTO A2601	<b>866</b>	
<b>L4</b>	2.2	<b>95 - 05</b>	MOTOR	FRONTAL / DER	<b>931</b>	
			MOTOR	TORSIÓN / FRONTAL	<b>983</b>	
			MOTOR	FRONTAL / DER / A/AC	<b>A2474</b>	
	2.3		MOTOR	FRONTAL	<b>A2872</b>	
			TRANSMISIÓN	AUT / IZQ	<b>A2715</b>	
	2.4		TRANSMISIÓN	AUT / IZQ / REPUESTO A2715	<b>981</b>	
			TRANSMISIÓN	FRONTAL / TRASERO / IZQ / STD / 5 VEL.	<b>936</b>	

CONTINÚA...



# CHEVROLET

**AUTOS**

CAVALIER	MOTOR	MODELO	SOPORTE	ESPECIFICACIÓN	No. BUFALO
<b>L4</b>	2.2	<b>02 - 05</b>	MOTOR	FRONTAL / DER / REFORZADO / MOT. 2.2.	<b>PRÓXIMAMENTE</b>
	2.3		MOTOR	FRONTAL / DER / MOT. 2.2 / REPUESTO A2947	<b>984</b>
	2.4		MOTOR	FRONTAL / DER / A/AC	<b>A2474</b>
<b>V6</b>	2.8	<b>85 - 95</b>	MOTOR	FRONTAL / DER/ AUT	<b>890</b>
			MOTOR	FRONTAL / DER/ STD	<b>890 - A</b>
			MOTOR	TRASERO / DER	<b>899</b>
			MOTOR	TORSIÓN / TRASERO	<b>882</b>
			MOTOR	TORSIÓN / TRASERO / MOT. 2.8	<b>A2947</b>
	3.1	TRANSMISIÓN	AUT / STD	<b>A2601</b>	
		TRANSMISIÓN	AUT / STD / REPUESTO A2601	<b>866</b>	
	<b>TODOS</b>	MOTOR	DER	<b>A103-C</b>	
		MOTOR	DER / REPUESTO A103-C	<b>A103</b>	

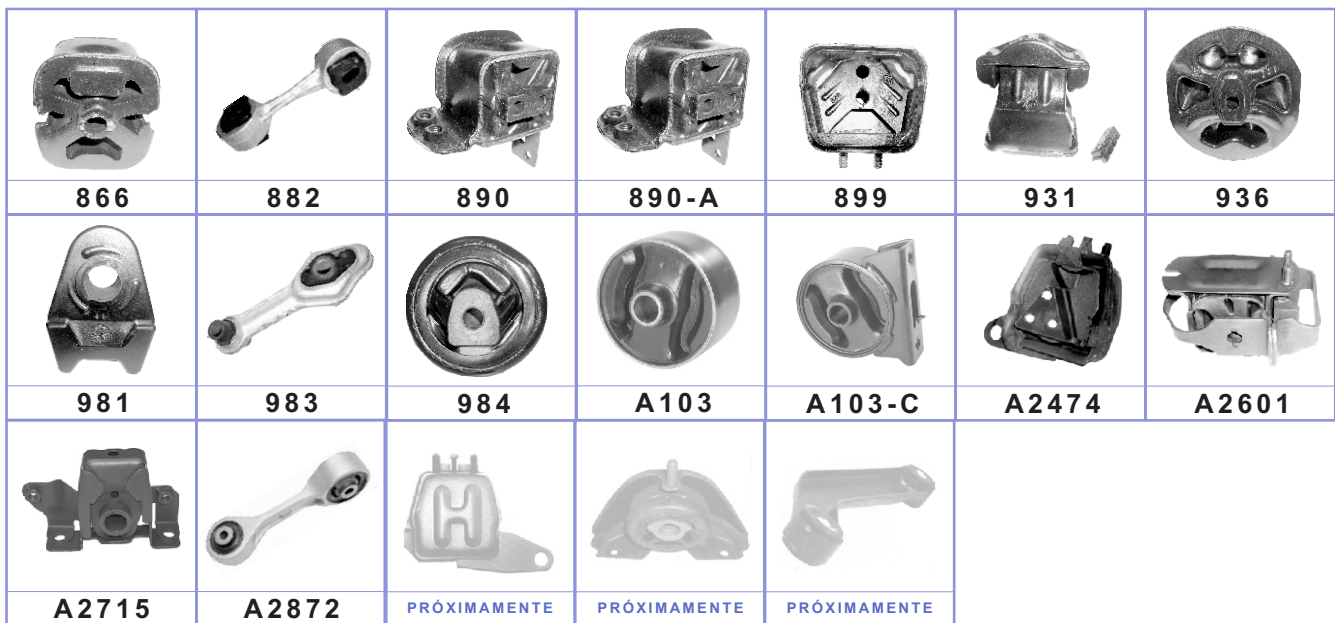

CELEBRITY	MOTOR	MODELO	SOPORTE	ESPECIFICACIÓN	No. BUFALO
<b>L4</b>	2.5	<b>82 - 95</b>	MOTOR	FRONTAL / DER / INF / MOT. 2.5 Y 2.8	<b>824</b>
			MOTOR	FRONT / DER	<b>836</b>
			MOTOR	TORSIÓN / FRONTAL / AUT / STD	<b>794</b>
<b>V6</b>	2.8		MOTOR	TORSIÓN / FRONTAL / REPUESTO 794	<b>794 - R</b>
			TRANSMISIÓN	FRONTAL / IZQ	<b>804</b>
<b>V6</b>	3.1		TRANSMISIÓN	TRASERO / IZQ	<b>805</b>
		TRANSMISIÓN		<b>A2783</b>	







CENTURY	MOTOR	MODELO	SOPORTE	ESPECIFICACIÓN	No. BUFALO
L4	2.2	93 - 94	MOTOR	TORSIÓN / FRONTAL / DER / IZQ / FUERZA DESPEGUE	794
		93 - 96	MOTOR	FRONTAL / DER	836
			TRANSMISIÓN		A2783
		95 - 96	MOTOR	TORSIÓN / FRONTAL	A2866
L4	2.5	82 - 84	MOTOR	FRONTAL / DER	824
			TRANSMISIÓN	FRONTAL / IZQ	804
			TRANSMISIÓN	TRASERO / IZQ	805
		82 - 92	TRANSMISIÓN	TORSIÓN / FRONTAL	794
			TRANSMISIÓN	TORSIÓN / FRONTAL / REPUESTO 794	794-R
		85 - 92	MOTOR	FRONTAL / DER	836
			TRANSMISIÓN		A2783
		V6	2.8	83 - 95	MOTOR
MOTOR	TORSIÓN / FRONTAL				PRÓXIMAMENTE
TRANSMISIÓN	FRONTAL / IZQ / AUT / STD				804
TRANSMISIÓN	TRASERO / IZQ / AUT / STD				805
85 - 95	MOTOR			FRONTAL / DER	836
86 - 95	MOTOR			TORSIÓN / FRONTAL	794
	MOTOR			TORSIÓN / FRONTAL / REPUESTO 794	794-R
V6	3.0			82 - 94	MOTOR
		MOTOR	TORSIÓN / FRONTAL		PRÓXIMAMENTE
		82 - 85	TRANSMISIÓN	FRONTAL / IZQ	804
			TRANSMISIÓN	TRASERO / IZQ	805
		85	MOTOR	FRONTAL / DER	836
		V6	3.1	94	MOTOR
MOTOR	TORSIÓN / FRONTAL / REPUESTO 794				794-R
94 - 96	MOTOR			FRONTAL / DER	836
	TRANSMISIÓN			FRONTAL / IZQ / AUT / STD	804
TRANSMISIÓN	TRASERO / IZQ / AUT / STD			805	
V6	3.1			95 - 05	MOTOR
		MOTOR	FRONTAL / INF / DER / IZQ / BRACKET RADIADOR		A2901
		97 - 05	MOTOR	FRONTAL / DER	A2796H
			TRANSMISIÓN		A2818
V6	3.3	89 - 93	MOTOR	FRONTAL / DER	836
			MOTOR	TORSIÓN / FRONTAL	794
			MOTOR	TORSIÓN / FRONTAL / REPUESTO 794	794-R
			TRANSMISIÓN	FRONTAL / IZQ / AUT / STD	804
			TRANSMISIÓN	TRASERO / IZQ / AUT / STD	805



# CHEVROLET

**AUTOS**

CENTURY	MOTOR	MODELO	SOPORTE	ESPECIFICACIÓN	No. BUFALO
V6	3.8	75 - 77	MOTOR	FRONTAL / IZQ	<b>A2383</b>
			TRANSMISIÓN		<b>930</b>
		75 - 81	MOTOR	FRONTAL / DER	<b>A2384</b>
			TRANSMISIÓN		<b>A2379</b>
		78 - 81	MOTOR	FRONTAL / IZQ	<b>A2382</b>
		84	MOTOR	FRONTAL / DER	<b>824</b>
		84 - 86	MOTOR	TORSIÓN / FRONTAL	<b>PRÓXIMAMENTE</b>
		84 - 88	TRANSMISIÓN	FRONTAL / IZQ / AUT / STD	<b>804</b>
			TRANSMISIÓN	TRASERO / IZQ / AUT / STD	<b>805</b>
		85 - 88	MOTOR	FRONTAL / DER	<b>836</b>
87 - 88	MOTOR	TORSIÓN / FRONTAL	<b>794</b>		
	MOTOR	TORSIÓN / FRONTAL / REPUESTO 794	<b>794-R</b>		

<b>794</b>	<b>794-R</b>	<b>804</b>	<b>805</b>	<b>824</b>	<b>836</b>	<b>930</b>
<b>A2379</b>	<b>A2382</b>	<b>A2383</b>	<b>A2384</b>	<b>A2783</b>	<b>A2796HY</b>	<b>A2818</b>
<b>A2866</b>	<b>A2901</b>	<b>PRÓXIMAMENTE</b>				

CHEVETTE	MOTOR	MODELO	SOPORTE	ESPECIFICACIÓN	No. BUFALO
L4	1.4	76 - 87	MOTOR	FRONTAL / DER / IZQ	<b>A2381</b>
	1.6		TRANSMISIÓN	DER / IZQ	<b>A2391</b>
	1.8				
V6 V8		58 - 74	TRANSMISIÓN		<b>223-A</b>
		66 - 88	MOTOR	DER / IZQ	<b>A2283</b>
			TRANSMISIÓN	AUT / STD	<b>727</b>

<b>223-A</b>	<b>727</b>	<b>A2283</b>	<b>A2381</b>	<b>A2391</b>

CHEVY VIEJO	MOTOR	MODELO	SOPORTE	ESPECIFICACIÓN	No. BUFALO
	V8 305	73 - 83	MOTOR	FRONTAL / DER	722
			MOTOR	FRONTAL / IZQ	722-A
			TRANSMISIÓN		711
			TRANSMISIÓN	AUT / STD	727

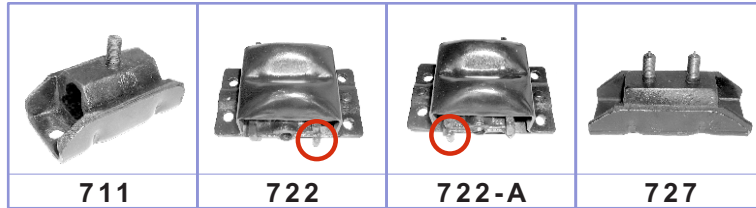

CHEVY , C2 POP, SWING JOY, MONZA	MOTOR	MODELO	SOPORTE	ESPECIFICACIÓN	No. BUFALO	
	L4 1.4 1.6	88 - 93	MOTOR	FRONTAL / DER / IMPORTADO	PRÓXIMAMENTE	
			MOTOR	FRONTAL / DER	922-A	
		94 - 10	MOTOR	FRONTAL / IZQ	922	
			TRANSMISIÓN		923	
			TRANSMISIÓN	FRONTAL / INF	977	
		87 - 10	02 - 08	MOTOR	FRONTAL / INF / AIRE ACONDICIONADO	976
				MOTOR	FRONTAL / DER	956
					MOTOR	FRONTAL / DER / AIRE ACONDICIONADO



CITATION	MOTOR	MODELO	SOPORTE	ESPECIFICACIÓN	No. BUFALO
	L4 2.5	80 - 95	MOTOR	FRONTAL / DER	824
			TRANSMISIÓN	FRONTAL / IZQ	804
			TRANSMISIÓN	TRASERO / IZQ	805
	V6 2.8	82 - 95	MOTOR	TORSIÓN / FRONTAL	794
				TORSIÓN / FRONTAL / REPUESTO 794	794-R

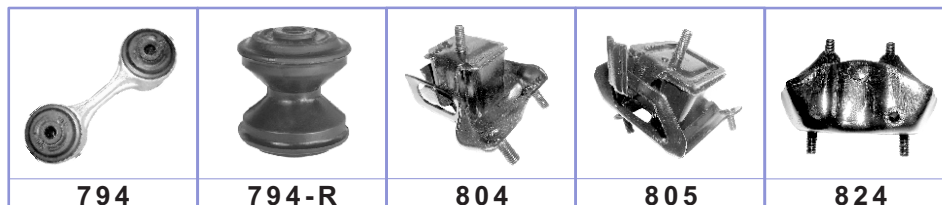



# CHEVROLET

**AUTOS**

CITATION II		MOTOR	MODELO	SOPORTE	ESPECIFICACIÓN	No. BUFALO
L4	2.5	84 - 95	MOTOR	FRONTAL / DER	824	
			TRANSMISIÓN	A2783		
	TRANSMISIÓN		FRONTAL / IZQ	804		
	TRANSMISIÓN		TRASERO / IZQ	805		
V6	2.8	85 - 95	MOTOR	FRONTAL / DER	836	



COBALT		MOTOR	MODELO	SOPORTE	ESPECIFICACIÓN	No. BUFALO
L4	2.0	05 - 07	MOTOR	FRONTAL / DER / STD	PRÓXIMAMENTE	
L4	2.2	05 - 08	TRANSMISIÓN	FRONTAL / TRASERO	PRÓXIMAMENTE	
			TRANSMISIÓN	FRONTAL / AUT	PRÓXIMAMENTE	
			TRANSMISIÓN	TRASERO / AUT / STD	PRÓXIMAMENTE	
		05 - 09	MOTOR	FRONTAL / DER / STD	PRÓXIMAMENTE	
			MOTOR	FRONTAL / DER / AUT	PRÓXIMAMENTE	





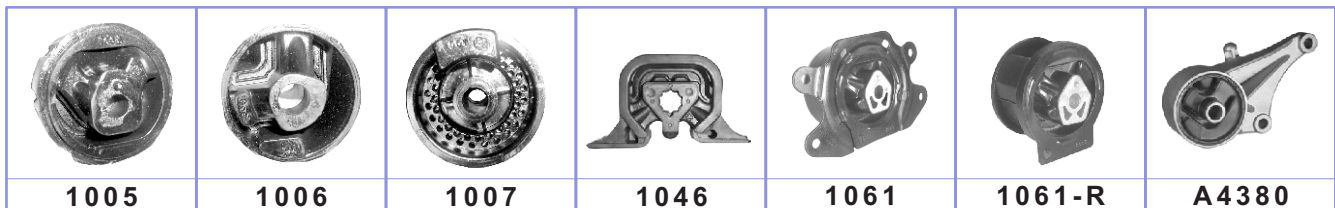









CORSA		MOTOR	MODELO	SOPORTE	ESPECIFICACIÓN	No. BUFALO
L4	1.8 2.0	02 - 08	MOTOR	FRONTAL / REPUESTO	1006	
			MOTOR	FRONTAL / DER / STD / EASY TRONIC	1046	
			MOTOR	TRASERO	A9390	
			MOTOR	TRASERO	PRÓXIMAMENTE	
			TRANSMISIÓN	FRONTAL / INF	A4380	
			TRANSMISIÓN	FRONTAL / SUP	1061	
			TRANSMISIÓN	TRASERO	1005	
			MOTOR	IZQ	1006	
			MOTOR	FRONTAL	1007	
			TRANSMISIÓN	IZQ	1061	
			TRANSMISIÓN	IZQ	1061R	

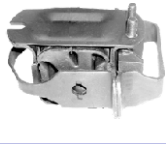

<b>CORSA</b>		
	<b>A9390</b>	<b>PRÓXIMAMENTE</b>

<b>CORSICA</b>	MOTOR	MODELO	SOPORTE	ESPECIFICACIÓN	No. <b>BUFALO</b>
<b>L4</b>	2.0	<b>87 - 91</b>	MOTOR	FRONTAL / DER	<b>890</b>
			TRANSMISIÓN	DER	<b>899</b>
	TRANSMISIÓN		TORSIÓN	<b>882</b>	
	TRANSMISIÓN		REPUESTO A2601	<b>866</b>	
	TRANSMISIÓN			<b>A2601</b>	
<b>L4</b>	2.2	<b>92 - 96</b>	MOTOR	FRONTAL / DER	<b>931</b>
			MOTOR	TORSIÓN / FRONTAL	<b>983-A</b>
			TRANSMISIÓN	REPUESTO A2715	<b>981</b>
		TRANSMISIÓN		<b>A2715</b>	
		<b>95 - 96</b>	MOTOR	TORSIÓN / FRONTAL	<b>983</b>
<b>L4</b>	2.8	<b>87 - 91</b>	MOTOR	FRONTAL / DER / STD	<b>890</b>
			MOTOR	FRONTAL / DER / AUT	<b>890-A</b>
			MOTOR	TRASERO / DER	<b>899</b>
	3.1		MOTOR	TORSIÓN / TRASERO	<b>882</b>
			MOTOR	TORSIÓN / TRASERO / LATERAL / MOT. 2.8	<b>PROXIMAMENTE</b>
			TRANSMISIÓN	REPUESTO A2601	<b>866</b>
			TRANSMISIÓN		<b>A2601</b>
<b>V6</b>	3.1	<b>92 - 94</b>	MOTOR	TORSIÓN / FRONTAL	<b>983-A</b>
		<b>92 - 95</b>	TRANSMISIÓN	FRONTAL / IZQ	<b>936</b>
		<b>92 - 96</b>	MOTOR	FRONTAL / DER	<b>931</b>
			TRANSMISIÓN	REPUESTO A2715	<b>981</b>
			TRANSMISIÓN		<b>A2715</b>
		<b>95 - 96</b>	MOTOR	TORSIÓN / FRONTAL	<b>983</b>

						
<b>866</b>	<b>882</b>	<b>890</b>	<b>890-A</b>	<b>899</b>	<b>931</b>	<b>936</b>
						
<b>981</b>	<b>983</b>	<b>983-A</b>	<b>A2601</b>	<b>A2715</b>	<b>PRÓXIMAMENTE</b>	



**CHEVROLET**  
AUTOS

CORVETTE	MOTOR	MODELO	SOPORTE	ESPECIFICACIÓN	No. BUFALO
	V8 5.7	84 - 91	MOTOR	FRONTAL / DER / IZQ	<b>919</b>
		97 - 04	MOTOR	FRONTAL / DER / IZQ	PRÓXIMAMENTE
			TRANSMISIÓN		PRÓXIMAMENTE

		
<b>919</b>	PRÓXIMAMENTE	PRÓXIMAMENTE



**CALIDAD Y GARANTÍA  
DE EXPORTACIÓN**

CUTLASS NACIONAL	MOTOR	MODELO	SOPORTE	ESPECIFICACIÓN	No. BUFALO
	V6	2.8	82 - 97	MOTOR	FRONTAL / AUT / STD / FUERZA DE DESPEGUE
MOTOR				REPUESTO 794	794-R
3.1		85 - 88	MOTOR	FRONTAL / DER	824
			TRANSMISIÓN	FRONTAL / IZQ	804
		85 - 97	TRANSMISIÓN	TRASERO / IZQ	805
			MOTOR	FRONTAL / DER	836

V6	3.1	97 - 99	MOTOR	FRONTAL / DER	PRÓXIMAMENTE
			TRANSMISIÓN	CENTRAL	A2874
			MOTOR	FRONTAL / TRASERO / IZQ	982-A
			TRANSMISIÓN	IZQ	982
			TRANSMISIÓN	FRONTAL / IZQ	PRÓXIMAMENTE
			TRANSMISIÓN	TRASERO / IZQ	PRÓXIMAMENTE

CUTLASS CALAIS "OLDSMOBILE"	MOTOR	MODELO	SOPORTE	ESPECIFICACIÓN	No. BUFALO
	L4	2.3	88 - 91	MOTOR	FRONTAL / DER
MOTOR				TORSIÓN / TRASERO	882
TRANSMISIÓN					936

L4	2.5	85 - 91	MOTOR	FRONTAL / DER / AUT	890
			MOTOR	FRONTAL / DER / STD	890-A
			MOTOR	TRASERO / DER	899
			MOTOR	TORSIÓN / TRASERO	882
			TRANSMISIÓN	REPUESTO A2601	866
			TRANSMISIÓN		A2601

V6	3.0	85 - 91	MOTOR	FRONTAL / DER	A2626
			MOTOR	TRASERO / DER	899
	3.3		MOTOR	TORSIÓN / TRASERO	882
			TRANSMISIÓN	REPUESTO A2601	866
			TRANSMISIÓN		A2601

V6	3.8	78 - 79	TRANSMISIÓN	STD	898
		78 - 84	MOTOR	FRONTAL / IZQ	A2382
			MOTOR	FRONTAL / DER	A2384
			TRANSMISIÓN	AUT / STD	A2379

V6	4.3	78 - 79	TRANSMISIÓN	STD	898
		78 - 82	MOTOR	FRONTAL / DER / IZQ	PRÓXIMAMENTE
		78 - 84	MOTOR	FRONTAL / DER / IZQ	846
		83 - 84	TRANSMISIÓN	AUT / STD	930

CUTLASS CIERA "OLDSMOBILE"	MOTOR	MODELO	SOPORTE	ESPECIFICACIÓN	No. BUFALO
	L4	2.2	93 - 94	MOTOR	TORSIÓN / FRONTAL
MOTOR				FRONTAL / DER	836
93 - 96			TRANSMISIÓN		A2783
			95 - 96	MOTOR	TORSIÓN / FRONTAL

CONTINÚA...



# CHEVROLET

**AUTOS**

<b>CUTLASS CIERA</b> "OLDSMOBILE"	<b>L4</b>	2.5	<b>82 - 84</b>	MOTOR	FRONTAL / DER	<b>824</b>
				TRANSMISIÓN	FRONTAL / IZQ	<b>804</b>
				TRANSMISIÓN	TRASERO / IZQ	<b>805</b>
		<b>82 - 92</b>	MOTOR	TORSIÓN / FRONTAL	<b>794</b>	
			MOTOR	TORSIÓN / FRONTAL	<b>836</b>	
			TRANSMISIÓN		<b>A2783</b>	

<b>V6</b>	2.8	<b>82 - 94</b>	MOTOR	FRONTAL / DER	<b>824</b>
			MOTOR	TORSIÓN / FRONTAL	<b>794</b>
			TRANSMISIÓN	FRONTAL / IZQ	<b>804</b>
	3.0	<b>82 - 89</b>	TRANSMISIÓN	TRASERO / IZQ	<b>805</b>
			MOTOR	FRONTAL / DER	<b>836</b>

<b>V6</b>	3.1	<b>94</b>	MOTOR	TORSIÓN / FRONTAL	<b>794</b>
			MOTOR	FRONTAL / DER	<b>836</b>
		<b>94 - 96</b>	TRANSMISIÓN	FRONTAL / IZQ	<b>804</b>
			TRANSMISIÓN	TRASERO / IZQ	<b>805</b>
		<b>95 - 96</b>	MOTOR	TORSIÓN / FRONTAL	<b>PRÓXIMAMENTE</b>

<b>V6</b>	3.3	<b>89 - 93</b>	MOTOR	FRONTAL / DER	<b>794</b>
			MOTOR	FRONTAL / DER	<b>836</b>
			TRANSMISIÓN	FRONTAL / IZQ	<b>804</b>
			TRANSMISIÓN	TRASERO / IZQ	<b>805</b>

<b>V6</b>	3.8	<b>84</b>	MOTOR	FRONTAL / DER	<b>824</b>
		<b>84 - 86</b>	MOTOR	TORSIÓN / FRONTAL	<b>A2609</b>
			TRANSMISIÓN	FRONTAL / IZQ	<b>804</b>
		<b>84 - 88</b>	TRANSMISIÓN	TRASERO / IZQ	<b>805</b>
			<b>85 - 88</b>	MOTOR	FRONTAL / DER
		<b>87 - 88</b>	MOTOR	TORSIÓN / FRONTAL	<b>794</b>

<b>CUTLASS SUPREME</b> "OLDSMOBILE"	<b>L4</b>	2.3	<b>90 - 91</b>	MOTOR	ESPECIFICACIÓN	<b>No. BUFALO</b>
				MOTOR	FRONTAL	<b>A2796HY</b>
				MOTOR	TORSIÓN / FRONTAL	<b>794</b>
				TRANSMISIÓN		<b>A2626</b>

<b>V6</b>	2.8	<b>88 - 89</b>	MOTOR	FRONTAL / DER	<b>A2796HY</b>
			MOTOR	TORSIÓN / FRONTAL / DER	<b>A2609</b>
			TRANSMISIÓN		<b>PRÓXIMAMENTE</b>

<b>V6</b>	3.1	<b>89 - 93</b>	MOTOR	FRONTAL / DER	<b>A2796HY</b>
			TRANSMISIÓN	AUT	<b>PRÓXIMAMENTE</b>
		<b>89 - 94</b>	MOTOR	TORSIÓN / FRONTAL / DER / IZQ / 1ra EDICIÓN	<b>A2609</b>
			MOTOR	FRONTAL / INF / DER / IZQ / BRACKET RADIADOR	<b>A2901</b>
		<b>94 - 97</b>	MOTOR	FRONTAL / DER	<b>A2796H</b>
			MOTOR	TORSIÓN / FRONTAL / DER / IZQ / 2da EDICIÓN	<b>PRÓXIMAMENTE</b>
TRANSMISIÓN			<b>A2712</b>		

CONTINÚA...



<b>CUTLASS SUPREME "OLDSMOBILE"</b>	V6	3.4	91-92/94-96	TRANSMISIÓN	AUT	<b>A2712</b>
			91 - 96	MOTOR	FRONTAL / DER	<b>A2555</b>
				MOTOR	TORSIÓN / FRONTAL	<b>A2799</b>
			93	TRANSMISIÓN		<b>805</b>

V8	4.1	85	TRANSMISIÓN	FRONTAL / IZQ / MOT. 4.3	<b>A2800</b>
			MOTOR	FRONTAL / DER	<b>A2553</b>
V6	4.3	94 - 96	TRANSMISIÓN	FRONTAL / IZQ	<b>804</b>
			TRANSMISIÓN	TRASERO / IZQ	<b>A2568</b>
V8	4.3		TRANSMISIÓN	TORSIÓN / FRONTAL	<b>A2556</b>

<b>794</b>	<b>794-R</b>	<b>804</b>	<b>805</b>	<b>824</b>	<b>836</b>	<b>846</b>
<b>866</b>	<b>882</b>	<b>890</b>	<b>890-A</b>	<b>898</b>	<b>899</b>	<b>930</b>
<b>936</b>	<b>982</b>	<b>982-A</b>	<b>A2379</b>	<b>A2382</b>	<b>A2384</b>	<b>A2553</b>
<b>A2555</b>	<b>A2556</b>	<b>A2568</b>	<b>A2601</b>	<b>A2609</b>	<b>A2626</b>	<b>A2712</b>
<b>A2783</b>	<b>A2796HY</b>	<b>A2799</b>	<b>A2800</b>	<b>A2874</b>	<b>A2901</b>	<b>PRÓXIMAMENTE</b>
<b>PRÓXIMAMENTE</b>	<b>PRÓXIMAMENTE</b>	<b>PRÓXIMAMENTE</b>	<b>PRÓXIMAMENTE</b>	<b>PRÓXIMAMENTE</b>	<b>PRÓXIMAMENTE</b>	



# CHEVROLET

**AUTOS**

DEVILLE "CADILLAC"	MOTOR	MODELO	SOPORTE	ESPECIFICACIÓN	No. BUFALO
	V6 4.3		MOTOR	DER / FRONTAL	<b>A2553</b>

V8 4.6	86 - 87	TRANSMISIÓN	IZQ	<b>A2783</b>
	88 - 90	TRANSMISIÓN	DER	<b>A2556</b>
	81 - 95	TRANSMISIÓN	DER	<b>A2555</b>
	93 - 02	MOTOR	TORSIÓN / FRONTAL / DER	<b>A2780</b>
		MOTOR	TORSIÓN / FRONTAL / IZQ	<b>A2781</b>
		MOTOR	FRONTAL / DER	<b>A2836</b>
		MOTOR	DER	<b>A2838</b>
		TRANSMISIÓN	DER	<b>A2837HY</b>
	94 - 94	TRANSMISIÓN	IZQ / AUT / 4 VEL	PRÓXIMAMENTE
	97 - 99	TRANSMISIÓN	IZQ / AUT / 4 VEL	PRÓXIMAMENTE
00 - 04	TRANSMISIÓN	FRONTAL / IZQ	PRÓXIMAMENTE	
00 - 05	TRANSMISIÓN	CENTRAL	PRÓXIMAMENTE	

V8 4.9	91 - 93	MOTOR	FRONTAL / DER	<b>A2553</b>
		TRANSMISIÓN	FRONTAL / IZQ	<b>A2800</b>
		TRANSMISIÓN	TRASERO / IZQ	<b>A2568</b>
		TRANSMISIÓN	TRASERO / DER	PRÓXIMAMENTE
	92 - 93	MOTOR	FRONTAL / DER	<b>A2836</b>
		MOTOR	TORSIÓN / FRONTAL / REPUESTO 794	<b>794-R</b>
MOTOR		TORSIÓN / FRONTAL	<b>794</b>	

<b>794</b>	<b>794-R</b>	<b>A2553</b>	<b>A2555</b>	<b>A2556</b>	<b>A2568</b>	<b>A2780</b>
<b>A2781</b>	<b>A2783</b>	<b>A2800</b>	<b>A2836</b>	<b>A2837HY</b>	<b>A2838</b>	PRÓXIMAMENTE
PRÓXIMAMENTE	PRÓXIMAMENTE	PRÓXIMAMENTE				

EL DORADO		MOTOR	MODELO	SOPORTE	ESPECIFICACIÓN	No. BUFALO
V8	4.5	86 - 87	TRANSMISIÓN		IZQ	<b>A 2783</b>
			MOTOR		TORSIÓN / FRONTAL	<b>794</b>
		88 - 90	TRANSMISIÓN		IZQ	<b>836</b>
V8	4.6	93 - 96	TRANSMISIÓN		IZQ	<b>PRÓXIMAMENTE</b>
			MOTOR		FRONTAL / DER	<b>A 2838</b>
		93 - 02	MOTOR		TORSIÓN / FRONTAL / IZQ	<b>A 2781</b>
			MOTOR		TORSIÓN / FRONTAL / DER	<b>A 2780</b>
			TRANSMISIÓN		IZQ	<b>A 2836</b>
		97 - 02	TRANSMISIÓN		IZQ	<b>A 2837HY</b>
V8	4.9	91	MOTOR		FRONTAL / DER	<b>A 2836</b>
			MOTOR		TORSIÓN / FRONTAL	<b>794</b>
		91 - 93	MOTOR		TORSIÓN / FRONTAL / REPUESTO 794	<b>794-R</b>
			92 - 93	TRANSMISIÓN		IZQ

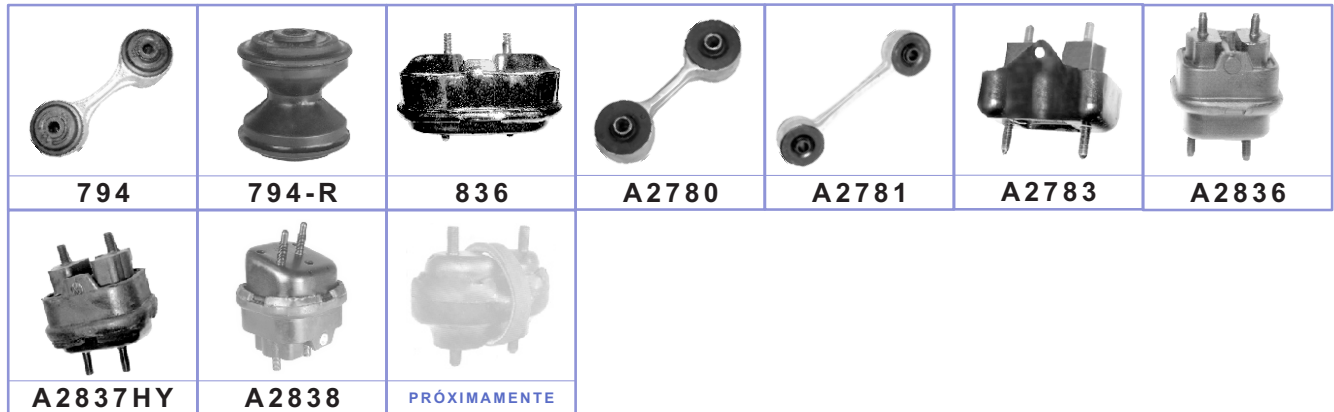

ELECTRA "BUICK"		MOTOR	MODELO	SOPORTE	ESPECIFICACIÓN	No. BUFALO
V6	3.0	85 - 86	TRANSMISIÓN		TRASERO / DER / 3 TORNILLOS	<b>PRÓXIMAMENTE</b>
			TRANSMISIÓN		TRASERO / DER / 4 TORNILLOS	<b>A 2664</b>
		MOTOR		FRONTAL / DER	<b>A 2553</b>	
	3.8	85 - 90	TRANSMISIÓN		FRONTAL / IZQ	<b>804</b>
			TRANSMISIÓN		TRASERO / IZQ	<b>A 2568</b>
			TRANSMISIÓN		TRASERO / DER	<b>A 2556</b>
V8	4.3	85 - 86	MOTOR		FRONTAL / DER	<b>A 2553</b>
			TRANSMISIÓN		FRONTAL / IZQ	<b>804</b>
			TRANSMISIÓN		TRASERO / IZQ	<b>A 2568</b>
			TRANSMISIÓN		TRASERO / DER	<b>A 2556</b>
V8	4.9	80	MOTOR		FRONTAL / DER / IZQ	<b>A 2387</b>
			TRANSMISIÓN		FRONTAL / IZQ	<b>711</b>



# CHEVROLET

**AUTOS**

<b>ELEKTRA</b> "BUICK"						
	<b>711</b>	<b>804</b>	<b>A2387</b>	<b>A2553</b>	<b>A2556</b>	<b>A2568</b>
<b>A2664</b>	<b>PRÓXIMAMENTE</b>					

<b>FIREBIRD</b> "PONTIAC"	MOTOR	MODELO	SOPORTE	ESPECIFICACIÓN	No. BUFALO	
<b>L4</b>	2.5	<b>82 - 86</b>	MOTOR	FRONTAL / IZQ	<b>A2549</b>	
			MOTOR	FRONTAL / DER	<b>A2550</b>	
			TRANSMISIÓN		<b>930</b>	
<b>V6</b>	2.8	<b>82 - 86</b>	TRANSMISIÓN		<b>A2393</b>	
			MOTOR	FRONTAL / DER / IZQ	<b>919</b>	
			TRANSMISIÓN		<b>930</b>	
			TRANSMISIÓN		<b>PRÓXIMAMENTE</b>	
<b>V6</b>	3.1	<b>90 - 92</b>	MOTOR	FRONTAL / DER / IZQ	<b>919</b>	
			TRANSMISIÓN		<b>PRÓXIMAMENTE</b>	
<b>V6</b>	3.4	<b>93 - 95</b>	MOTOR	FRONTAL / DER / IZQ	<b>919</b>	
			TRANSMISIÓN		<b>A2880</b>	
<b>V6</b>	3.8	<b>77</b>	MOTOR	FRONTAL / IZQ	<b>A2383</b>	
			MOTOR	FRONTAL / DER	<b>A2384</b>	
			TRANSMISIÓN		<b>PRÓXIMAMENTE</b>	
			MOTOR	FRONTAL / IZQ	<b>A2382</b>	
			MOTOR	<i>TURBO</i>	<b>985</b>	
			<b>95 - 02</b>	MOTOR	FRONTAL / IZQ	<b>919</b>
				MOTOR	FRONTAL / DER	<b>PRÓXIMAMENTE</b>
		TRANSMISIÓN		<b>A2880</b>		

<b>919</b>	<b>930</b>	<b>985</b>	<b>A2382</b>	<b>A2383</b>	<b>A2384</b>	<b>A2393</b>

CONTINÚA...

<b>FIREBIRD</b> "PONTIAC"					
	<b>A2549</b>	<b>A2550</b>	<b>A2880HY</b>	PRÓXIMAMENTE	PRÓXIMAMENTE

<b>FLEETWOOD</b> "CADILLAC"	MOTOR	MODELO	SOPORTE	ESPECIFICACIÓN	No. <b>BUFALO</b>	
	<b>V6</b>	4.1	<b>85 - 87</b>	TRANSMISIÓN	FRONTAL / IZQ / MOT. 4.1	<b>804</b>
		4.3		TRANSMISIÓN	FRONTAL / IZQ / MOT 4.3	<b>804</b>
	<b>V8</b>	4.1	<b>85 - 93</b>	MOTOR	FRONTAL	<b>A2553</b>
				TRANSMISIÓN	TRASERO / IZQ	<b>A2568</b>
	<b>V8</b>	4.5	<b>88 - 90</b>	TRANSMISIÓN	FRONTAL / IZQ	<b>804</b>
				TRANSMISIÓN	TRASERO / IZQ	<b>A2556</b>
	<b>V8</b>	4.9	<b>91 - 93</b>	TRANSMISIÓN	FRONTAL / IZQ	<b>A2800</b>
				TRANSMISIÓN	TRASERO / DER	PRÓXIMAMENTE

<b>804</b>	<b>A2553</b>	<b>A2556</b>	<b>A2568</b>	<b>A2800</b>	PRÓXIMAMENTE

<b>G3</b> "PONTIAC"	MOTOR	MODELO	SOPORTE	ESPECIFICACIÓN	No. <b>BUFALO</b>	
	<b>L4</b>	1.6	<b>08 - 10</b>	MOTOR	FRONTAL / DER	PRÓXIMAMENTE
				MOTOR	FRONTAL / DER	PRÓXIMAMENTE
				MOTOR	TRASERO	PRÓXIMAMENTE
				TRANSMISIÓN	REPUESTO	PRÓXIMAMENTE
				TRANSMISIÓN		PRÓXIMAMENTE

PRÓXIMAMENTE	PRÓXIMAMENTE	PRÓXIMAMENTE	PRÓXIMAMENTE	PRÓXIMAMENTE



# CHEVROLET

**AUTOS**

G5	MOTOR	MODELO	SOPORTE	ESPECIFICACIÓN	No. BUFALO	
<b>"PONTIAC"</b>	L4	2.2	07 - 08	MOTOR	FRONTAL / DER / STD	PRÓXIMAMENTE
				MOTOR	FRONTAL / AUT	PRÓXIMAMENTE
		2.4	07 - 09	MOTOR	FRONTAL / TRASERO / REPUESTO	PRÓXIMAMENTE
				TRANSMISIÓN	FRONTAL / AUT	PRÓXIMAMENTE
				TRANSMISIÓN	TRASERO / AUT / STD	PRÓXIMAMENTE



PRÓXIMAMENTE PRÓXIMAMENTE PRÓXIMAMENTE PRÓXIMAMENTE PRÓXIMAMENTE

G6	MOTOR	MODELO	SOPORTE	ESPECIFICACIÓN	No. BUFALO	
<b>"PONTIAC"</b>	L4	2.4	06 - 07	TRANSMISIÓN	TRASERO	PRÓXIMAMENTE
				TRANSMISIÓN	TRASERO	PRÓXIMAMENTE
		06 - 08	MOTOR	FRONTAL / DER	PRÓXIMAMENTE	
			09	MOTOR	FRONTAL / DER	PRÓXIMAMENTE
V6	3.5	05 - 07	TRANSMISIÓN	TRASERO	PRÓXIMAMENTE	
			TRANSMISIÓN	TRASERO	PRÓXIMAMENTE	
		05 - 09	MOTOR	FRONTAL / DER	PRÓXIMAMENTE	
V6	3.6	07 - 08	MOTOR	FRONTAL / DER	PRÓXIMAMENTE	
V6	3.9	06 - 08	MOTOR	FRONTAL / DER / AUT	PRÓXIMAMENTE	
			MOTOR	FRONTAL / DER / STD	PRÓXIMAMENTE	
		07	TRANSMISIÓN	CENTRAL	PRÓXIMAMENTE	



PRÓXIMAMENTE PRÓXIMAMENTE PRÓXIMAMENTE PRÓXIMAMENTE PRÓXIMAMENTE PRÓXIMAMENTE

GEO-METRO	MOTOR	MODELO	SOPORTE	ESPECIFICACIÓN	No. BUFALO
L3	1.0	89 - 00	MOTOR	FRONTAL	PRÓXIMAMENTE
			MOTOR	TORSIÓN / TRASERO	PRÓXIMAMENTE
L4	1.3		TRANSMISIÓN		PRÓXIMAMENTE



PRÓXIMAMENTE PRÓXIMAMENTE PRÓXIMAMENTE

GEO-PRIZM		MOTOR	MODELO	SOPORTE	ESPECIFICACIÓN	No. BUFALO	
L4	1.6	88 - 92	MOTOR	FRONTAL		<b>A 8180</b>	
				FRONTAL / STD / 5 VEL		<b>A 8181</b>	
		89 - 92	MOTOR	FRONTAL / AUT / 3 Y 4 VEL		PRÓXIMAMENTE	
				TRASERO / AUT / 3 VEL		PRÓXIMAMENTE	
			TRASERO / STD / 5 VEL		PRÓXIMAMENTE		
			TRANSMISIÓN	CENTRAL / STD		PRÓXIMAMENTE	
			91 - 92		MOTOR	TRASERO / AUT / 4 VEL	
		93 - 97	MOTOR	FRONTAL / AUT / 3 VEL		<b>A 8177</b>	
				FRONTAL / STD / 5 VEL		PRÓXIMAMENTE	
				FRONTAL / DER		<b>A 8178</b>	
				TRASERO		PRÓXIMAMENTE	
				TRASERO / STD		<b>A 8179</b>	
TRANSMISIÓN				PRÓXIMAMENTE			

L4	1.8	93 - 97	MOTOR	FRONTAL / STD	PRÓXIMAMENTE
			MOTOR	FRONTAL / AUT / 4 VEL	<b>A 8177</b>
			MOTOR	FRONTAL / DER	<b>A 8178</b>
			MOTOR	TRASERO / AUT	PRÓXIMAMENTE
			MOTOR	TRASERO / STD	<b>A 8179</b>
TRANSMISIÓN					PRÓXIMAMENTE



GEO-SPRINT		MOTOR	MODELO	SOPORTE	ESPECIFICACIÓN	No. BUFALO
L3	1.0	85 - 86	MOTOR	FRONTAL / STD		PROXIMAMENTE
				FRONTAL / AUT		<b>971-A</b>
		85 - 88	MOTOR	TORSIÓN / TRASERO		PROXIMAMENTE
				TRANSMISIÓN	STD / 5 VEL	
		87 - 91	MOTOR	FRONTAL / TURBO		PROXIMAMENTE





# CHEVROLET

**AUTOS**

GRAND-AM "PONTIAC"	MOTOR	MODELO	SOPORTE	ESPECIFICACIÓN	No. BUFALO	
L4	2.0	87 - 89	MOTOR	FRONTAL / DER / AUT	890	
			MOTOR	FRONTAL / DER / STD	890 - A	
			MOTOR	TRASERO / DER	899	
			MOTOR	TORSIÓN / TRASERO	882	
			MOTOR	TORSIÓN / TRASERO / LATERAL	PRÓXIMAMENTE	
			TRANSMISIÓN	REPUESTO A2601	866	
			TRANSMISIÓN		A2601	
L4	2.2	02 - 05	TRANSMISIÓN	CENTRAL	A2874	
			TRANSMISIÓN	TRASERO / IZQ / REPUESTO	982	
			TRANSMISIÓN	TORSIÓN / TRASERO	PRÓXIMAMENTE	
L4	2.3	88 - 91	MOTOR	FRONTAL / DER	PRÓXIMAMENTE	
			MOTOR	TORSIÓN / FRONTAL	882	
			TRANSMISIÓN	STD / 5 VEL	936	
		92 - 94	MOTOR	TORSIÓN / FRONTAL	983 - A	
			MOTOR	FRONTAL / DER	931	
		92 - 95	TRANSMISIÓN	REPUESTO A2715	981	
			TRANSMISIÓN		A2715	
			TRANSMISIÓN	FRONTAL / IZQ / STD	936	
			TRANSMISIÓN	TRASERO / IZQ / STD	936	
95	MOTOR	TORSIÓN / FRONTAL	983			
L4	2.4	96 - 98	MOTOR	FRONTAL / DER	931	
			MOTOR	TORSIÓN / FRONTAL / STD	983 - A	
			MOTOR	TORSIÓN / FRONTAL / AUT	983	
			TRANSMISIÓN	STD	936	
			TRANSMISIÓN	AUT / REPUESTO A2715	981	
			TRANSMISIÓN	AUT	A2715	
		99 - 01	MOTOR	FRONTAL	1015	
			TRANSMISIÓN	CENTRAL	983	
			TRANSMISIÓN	FRONTAL / TRASERO / IZQ / REPUESTO	982	
			TRANSMISIÓN	FRONTAL / IZQ	PRÓXIMAMENTE	
			TRANSMISIÓN	TRASERO / IZQ	PRÓXIMAMENTE	
L4	2.5	85 - 87	MOTOR	FRONTAL / DER / MOT. 3.0	890	
			MOTOR	FRONTAL / DER / MOT. 2.5	890	
			MOTOR	TRASERO / DER	899	
	V6	3.0	85 - 91	MOTOR	TORSIÓN / TRASERO	882
				TRANSMISIÓN	REPUESTO A2601	866
				TRANSMISIÓN		A2601
V6	3.1	94	MOTOR	TORSIÓN / FRONTAL	983 - A	
			MOTOR	FRONTAL / DER	931	
		94 - 98	MOTOR	TORSIÓN / FRONTAL	983	
			TRANSMISIÓN	STD / AUT / REPUESTO A2715	981	
			TRANSMISIÓN	STD / AUT	A2715	
		97 - 03	TRANSMISIÓN		A2874	



<b>GRAND-AM</b> "PONTIAC"	V6	3.3	92 - 93	MOTOR	FRONTAL / DER	<b>931</b>
				MOTOR	TORSIÓN / FRONTAL	<b>983-A</b>
				TRANSMISIÓN	AUT / STD / REPUESTO A2715	<b>981</b>
				TRANSMISIÓN	AUT / STD	<b>A2715</b>
V6	3.4	99 - 05	MOTOR	FRONTAL	<b>1015</b>	
			TRANSMISIÓN	CENTRAL	<b>A2874</b>	
			MOTOR	FRONTAL / TRASERO	<b>982-A</b>	
			TRANSMISIÓN	FRONTAL / TRASERO / IZQ	<b>982</b>	
			TRANSMISIÓN	FRONTAL / TRASERO / IZQ	<b>PRÓXIMAMENTE</b>	
V6	3.8	97 - 04	MOTOR	IZQ	<b>A2382</b>	
			MOTOR	DER	<b>A2384</b>	
			TRANSMISIÓN	TRASERO / IZQ	<b>A2823HY</b>	

<b>866</b>	<b>882</b>	<b>890</b>	<b>890-A</b>	<b>899</b>	<b>931</b>	<b>936</b>
<b>981</b>	<b>982</b>	<b>982-A</b>	<b>983</b>	<b>983-A</b>	<b>1015</b>	<b>A2382</b>
<b>A2384</b>	<b>A2601</b>	<b>A2715</b>	<b>A2823HY</b>	<b>A2874</b>	<b>PRÓXIMAMENTE</b>	<b>PRÓXIMAMENTE</b>
<b>PRÓXIMAMENTE</b>	<b>PRÓXIMAMENTE</b>					

# CALIDAD Y GARANTÍA



# CHEVROLET

**AUTOS**

GRAND-PRIX "PONTIAC"	MOTOR	MODELO	SOPORTE	ESPECIFICACIÓN	No. BUFALO
L4	2.3	90 - 91	MOTOR	FRONTAL	PRÓXIMAMENTE
			MOTOR	TORSIÓN / FRONTAL	794
			MOTOR	TORSIÓN / FRONTAL	794-R
			TRANSMISIÓN		PRÓXIMAMENTE
V6	2.8	88 - 89	MOTOR	FRONTAL / DER	A2796HY
			MOTOR	TORSIÓN / FRONTAL / DER	A2609
			TRANSMISIÓN	AUT	PRÓXIMAMENTE
V6	3.1	89 - 93	MOTOR	FRONTAL / DER	A2796HY
			TRANSMISIÓN	AUT	PRÓXIMAMENTE
		94 - 03	MOTOR	TORSIÓN / FRONTAL / DER / IZQ	A2609
			MOTOR	FRONTAL / INF / DER / IZQ / BRACKET RADIADOR	A2901
			MOTOR	FRONTAL / DER	A2796HY
			MOTOR	TORSIÓN / FRONTAL / DER / IZQ	A2866
TRANSMISIÓN	AUT	A2712			
V6	3.4	91	TRANSMISIÓN	AUT	A2712
		91 - 96	MOTOR	FRONTAL / DER	A2555
		91 - 99	MOTOR	TORSIÓN / FRONTAL	A2799
		92 - 93	TRANSMISIÓN	AUT	PRÓXIMAMENTE
		94 - 96	TRANSMISIÓN	AUT	A2712
V6	3.8	97 . 07	MOTOR	FRONTAL	A2796
			MOTOR	TORSIÓN / FRONTAL / IZQ	A2866
			TRANSMISIÓN	AUT / STD / 4 VEL	A2712
		97 - 08	MOTOR	FRONTAL / INF / DER / IZQ / BRACKET RADIADOR	PRÓXIMAMENTE
		06 - 07	TRANSMISIÓN	SIN SUPERCARGA	A2818
V8	5.3	05 - 08	MOTOR	FRONTAL	PRÓXIMAMENTE
			MOTOR	FRONTAL / DER / IZQ / BRACKET RADIADOR	PRÓXIMAMENTE
			MOTOR	TORSIÓN / FRONTAL / DER / IZQ	A2866

794	794-R	A2555	A2609	A2712	A2796HY	A2799
A2818	A2866	A2901	PRÓXIMAMENTE	PRÓXIMAMENTE	PRÓXIMAMENTE	PRÓXIMAMENTE

HHR	MOTOR	MODELO	SOPORTE	ESPECIFICACIÓN	No. BUFALO
	L4 2.0	08 - 09	MOTOR	FRONTAL / DER / STD	PRÓXIMAMENTE
			MOTOR	FRONTAL / DER / AUT	PRÓXIMAMENTE
			TRANSMISIÓN	FRONTAL / TRASERO	PRÓXIMAMENTE
			TRANSMISIÓN	FRONTAL / AUT	PRÓXIMAMENTE
			TRANSMISIÓN	TRASERO / AUT / STD	PRÓXIMAMENTE
L4	2.2	06 - 08	TRANSMISIÓN	FRONTAL / TRASERO	PRÓXIMAMENTE
			TRANSMISIÓN	FRONTAL / AUT	PRÓXIMAMENTE
			TRANSMISIÓN	TRASERO / AUT / STD	PRÓXIMAMENTE
	2.4	06 - 09	MOTOR	FRONTAL / DER / STD	PRÓXIMAMENTE
			MOTOR	FRONTAL / DER / AUT	PRÓXIMAMENTE



IMPALA	MOTOR	MODELO	SOPORTE	ESPECIFICACIÓN	No. BUFALO
"VIEJO"	L6 4.1	58 - 74	TRANSMISIÓN		223-A
			MOTOR	FRONTAL / DER / IZQ	849
	V8 5.0 5.7	75 - 85	TRANSMISIÓN	MOT. 305	711
			TRANSMISIÓN	AUT / STD	727

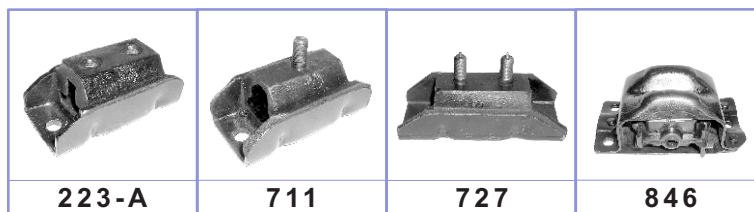

IMPALA	MOTOR	MODELO	SOPORTE	ESPECIFICACIÓN	No. BUFALO
	V6 3.4	00 - 05	MOTOR	FRONTAL / INF / DER / IZQ / BRACKET RADIADOR	A2901
			MOTOR	FRONTAL / DER	A2796HY
			MOTOR	TORSIÓN / FRONTAL / DER / IZQ	A2866
			TRANSMISIÓN	AUT	A2818
V6	3.5	06 - 10	MOTOR	FRONTAL / DER / IZQ / BRACKET RADIADOR	PRÓXIMAMENTE
			MOTOR	FRONTAL / IZQ	A2796HY
			MOTOR	TORSIÓN / FRONTAL / DER / IZQ	A2899
			TRANSMISIÓN	AUT	A2818



# CHEVROLET

**AUTOS**

<b>IMPALA</b>	V6 3.8	80 - 85	MOTOR	FRONTAL / IZQ	<b>A2382</b>	
			MOTOR	FRONTAL / DER	<b>A2384</b>	
			MOTOR	FRONTAL / DER / IZQ	<b>919</b>	
			TRANSMISIÓN		<b>A2379</b>	
				TRANSMISIÓN		<b>711</b>
		00 - 05	MOTOR	FRONTAL / INF / DER / IZQ / BRACHET RADIADOR	<b>PRÓXIMAMENTE</b>	
			MOTOR	FRONTAL / DER	<b>A2796HY</b>	
			MOTOR	TORSIÓN / FRONTAL / DER / IZQ	<b>A2866</b>	
TRANSMISIÓN			<b>A2712</b>			
V6 3.9	06 - 10	MOTOR	FRONTAL / DER / IZQ / BRACHET RADIADOR	<b>PRÓXIMAMENTE</b>		
		MOTOR	FRONTAL / DER	<b>A2796HY</b>		
		MOTOR	TORSIÓN / FRONTAL / DER / IZQ	<b>A2899</b>		
		TRANSMISIÓN		<b>A2712</b>		
L6 4.1 V8 4.4 5.0 5.7	73 - 85	MOTOR	FRONTAL / DER	<b>846</b>		
		TRANSMISIÓN	AUT	<b>711</b>		
		TRANSMISIÓN	STD / 3 VEL	<b>223</b>		
V8 5.3	06 - 09	MOTOR	FRONTAL	<b>PRÓXIMAMENTE</b>		
		TRANSMISIÓN		<b>PRÓXIMAMENTE</b>		
	06 - 10	MOTOR	FRONTAL / DER / IZQ / BRACHET RADIADOR	<b>PRÓXIMAMENTE</b>		
		MOTOR	TORSIÓN / FRONTAL / DER / IZQ	<b>A2899</b>		

<b>223</b>	<b>711</b>	<b>846</b>	<b>919</b>	<b>A2379</b>	<b>A2382</b>	<b>A2384</b>
<b>A2712</b>	<b>A2796HY</b>	<b>A2818</b>	<b>A2866</b>	<b>A2899</b>	<b>A2901</b>	<b>PRÓXIMAMENTE</b>
<b>PRÓXIMAMENTE</b>	<b>PRÓXIMAMENTE</b>	<b>PRÓXIMAMENTE</b>				

# CALIDAD Y GARANTÍA

INTRIGUE	MOTOR	MODELO	SOPORTE	ESPECIFICACIÓN	No. BUFALO	
	V6	3.5	99 - 02	MOTOR	FRONTAL	PRÓXIMAMENTE
				MOTOR	FRONTAL / DER / IZQ	PRÓXIMAMENTE
				MOTOR	TORSIÓN / FRONTAL / DER / IZQ	<b>A 2866</b>
				TRANSMISIÓN		PRÓXIMAMENTE
				TRANSMISIÓN		<b>A 2712</b>



LACROSSE "BUICK"	MOTOR	MODELO	SOPORTE	ESPECIFICACIÓN	No. BUFALO	
	V8	5.3	08	MOTOR	FRONTAL	PRÓXIMAMENTE
				MOTOR	FRONTAL / DER / IZQ / BRACKET RADIADOR	PRÓXIMAMENTE
				MOTOR	TORSIÓN / FRONTAL / DER / IZQ	<b>A 2899</b>
				TRANSMISIÓN		PRÓXIMAMENTE

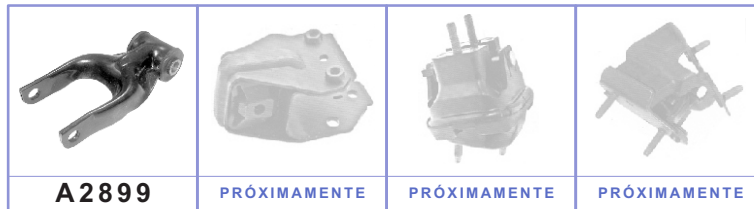

MR



# CHEVROLET

**AUTOS**

LE SABRE "BUICK"	MOTOR	MODELO	SOPORTE	ESPECIFICACIÓN	No. BUFALO
V6	3.0	86	TRANSMISIÓN	TRASERO / DER / 4 TORNILLOS	<b>A 2664</b>
			TRANSMISIÓN	TRASERO / DER / 3 TORNILLOS	PRÓXIMAMENTE
	3.8	86 - 91	MOTOR	FRONTAL / DER	<b>A 2553</b>
			TRANSMISIÓN	FRONTAL / IZQ	<b>804</b>
			TRANSMISIÓN	TRASERO / IZQ	<b>A 2568</b>
			TRANSMISIÓN	TRASERO / DER	<b>A 2556</b>

V6	3.8	76 - 77	MOTOR	FRONTAL / IZQ	<b>A 2383</b>	
		76 - 85	MOTOR	FRONTAL / DER	<b>A 2384</b>	
			TRANSMISIÓN		<b>A 2379</b>	
		92 - 93	MOTOR	FRONTAL / IZQ	<b>A 2382</b>	
			TRANSMISIÓN	FRONTAL / IZQ	<b>A 2800</b>	
			TRANSMISIÓN	TRASERO / IZQ	<b>A 2823HY</b>	
			MOTOR	FRONTAL / DER	<b>A 2801</b>	
		92 - 99	MOTOR	TORSIÓN / FRONTAL	<b>794</b>	
			MOTOR	TORSIÓN / FRONTAL / REPUESTO 794	<b>794 - R</b>	
			TRANSMISIÓN	FRONTAL / IZQ	<b>A 2881</b>	
		94 - 99	TRANSMISIÓN	TRASERO / IZQ	<b>A 2568</b>	
			TRANSMISIÓN	FRONTAL / IZQ	<b>A 2698</b>	
		00 - 04	MOTOR	FRONTAL / DER	PRÓXIMAMENTE	
			00 - 05	TRANSMISIÓN	CENTRAL	PRÓXIMAMENTE
				TRANSMISIÓN	TRASERO / IZQ	PRÓXIMAMENTE

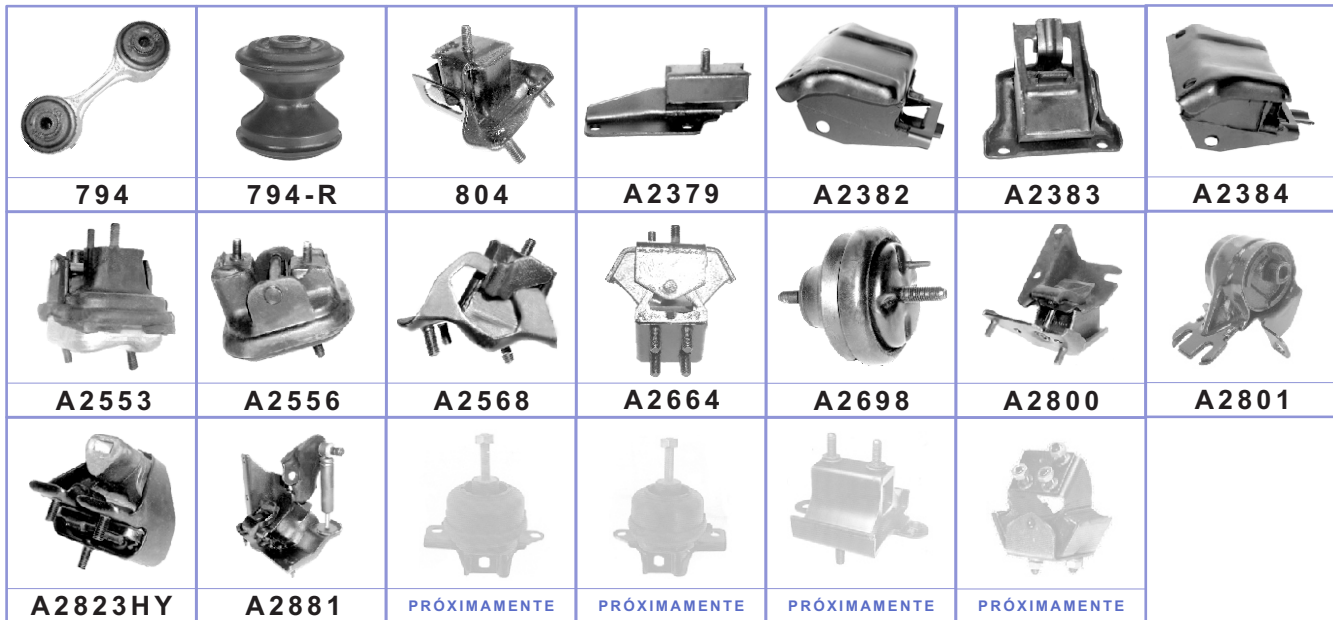

LUMINA	MOTOR	MODELO	SOPORTE	ESPECIFICACIÓN	No. BUFALO
L4	2.2	93	MOTOR	FRONTAL / DER	<b>931</b>
			MOTOR	TORSIÓN / FRONTAL	<b>983 - A</b>
			TRANSMISIÓN	AUT / 3 VEL / REPUESTO A2715	<b>981</b>
			TRANSMISIÓN	AUT / 3 VEL	<b>A 2715</b>

CONTINÚA...

<b>LUMINA</b>	L4	2.5	90 - 94	MOTOR	FRONTAL / DER	<b>A2796HY</b>
				MOTOR	TORSIÓN / FRONTAL	<b>A2609</b>
	V6	3.1		TRANSMISIÓN		<b>PRÓXIMAMENTE</b>

V6	3.1	90 - 94	MOTOR	TRASERO / DER	<b>A2676</b>
			MOTOR	FRONTAL / INF / DER / IZQ / BRACKET RADIADOR	<b>A2901</b>
			MOTOR	FRONTAL / DER	<b>A2796HY</b>
			MOTOR	TORSIÓN / FRONTAL / DER / IZQ	<b>A2866</b>
			TRANSMISIÓN		<b>A2712</b>

V6	3.4	91	TRANSMISIÓN	AUT / 4 VEL	<b>A2712</b>
		91 - 97	MOTOR	FRONTAL / DER	<b>A2555</b>
			MOTOR	TORSIÓN / FRONTAL	<b>A2799</b>
		92 - 93	TRANSMISIÓN	AUT / 4 VEL	<b>PRÓXIMAMENTE</b>
		94 - 97	TRANSMISIÓN	AUT / 4 VEL	<b>A2712</b>

V6	3.8	98 - 99	MOTOR	FRONTAL / INF / DER / IZQ / BRACKET RADIADOR	<b>A2901</b>
			MOTOR	FRONTAL / DER	<b>A2796HY</b>
			MOTOR	TORSIÓN / FRONTAL / DER / IZQ	<b>A2866</b>
			TRANSMISIÓN		<b>A2712</b>

<b>931</b>	<b>981</b>	<b>983-A</b>	<b>A2555</b>	<b>A2609</b>	<b>A2676</b>	<b>A2712</b>
<b>A2715</b>	<b>A2796HY</b>	<b>A2799</b>	<b>A2866</b>	<b>A2901</b>	<b>PRÓXIMAMENTE</b>	

<b>MALIBÚ</b> "VIEJO"	MOTOR	MODELO	SOPORTE	ESPECIFICACIÓN	No. <b>BUFALO</b>
	V8	58 - 74	MOTOR	DER / IZQ	<b>200</b>
			TRANSMISIÓN	TORSIÓN / FRONTAL	<b>223</b>
			TRANSMISIÓN		<b>223-A</b>

<b>200</b>	<b>223</b>	<b>223-A</b>



# CHEVROLET

**AUTOS**

MALIBÚ	MOTOR	MODELO	SOPORTE	ESPECIFICACIÓN	No. BUFALO
L4	2.2	04 - 08	MOTOR	FRONTAL / REPUESTO	PRÓXIMAMENTE
			MOTOR	FRONTAL	PRÓXIMAMENTE
			MOTOR	FRONTAL / DER	PRÓXIMAMENTE
			TRANSMISIÓN	TRASERO / REPUESTO	PRÓXIMAMENTE
			TRANSMISIÓN	TRASERO	PRÓXIMAMENTE
			TRANSMISIÓN	CENTRAL / REPUESTO	PRÓXIMAMENTE
			TRANSMISIÓN	CENTRAL	PRÓXIMAMENTE
L4	2.4	09 - 10	MOTOR	FRONTAL / DER	PRÓXIMAMENTE
		09 - 11	MOTOR	FRONTAL / REPUESTO	PRÓXIMAMENTE
			MOTOR	FRONTAL	PRÓXIMAMENTE
			MOTOR	FRONTAL / DER	PRÓXIMAMENTE
			TRANSMISIÓN	TRASERO / REPUESTO	PRÓXIMAMENTE
			TRANSMISIÓN	TRASERO	PRÓXIMAMENTE
			TRANSMISIÓN	CENTRAL	PRÓXIMAMENTE
V6	3.5	04 - 08	MOTOR	FRONTAL / REPUESTO	PRÓXIMAMENTE
			MOTOR	FRONTAL	PRÓXIMAMENTE
			MOTOR	FRONTAL / DER	PRÓXIMAMENTE
			MOTOR	TRASERO	PRÓXIMAMENTE
			TRANSMISIÓN	TRASERO / REPUESTO	PRÓXIMAMENTE
			TRANSMISIÓN	TRASERO	PRÓXIMAMENTE
V6	3.6	09 - 11	MOTOR	FRONTAL / REPUESTO	PRÓXIMAMENTE
			MOTOR	FRONTAL	PRÓXIMAMENTE
			MOTOR	FRONTAL / DER	PRÓXIMAMENTE
			MOTOR	TRASERO / REPUESTO	PRÓXIMAMENTE
			MOTOR	TRASERO	PRÓXIMAMENTE
			TRANSMISIÓN	PRÓXIMAMENTE	
V6	3.9	06 - 08	MOTOR	FRONTAL / DER	PRÓXIMAMENTE
			TRANSMISIÓN	CENTRAL	PRÓXIMAMENTE
		02 - 05	TRANSMISIÓN	CENTRAL / REPUESTO A2874	<b>1008</b>
			TRANSMISIÓN	CENTRAL	<b>A2874</b>





MALIBÚ "CLASSIC"		MOTOR	MODELO	SOPORTE	ESPECIFICACIÓN	No. BUFALO
L4	2.2	04 - 05	MOTOR	FRONTAL / DER	PRÓXIMAMENTE	
			TRANSMISIÓN	CENTRAL	A 2874	
			TRANSMISIÓN	CENTRAL / REPUESTO A2874	1008	
			TRANSMISIÓN	TRASERO / IZQ / REPUESTO	982	
			TRANSMISIÓN	TRASERO / IZQ	PRÓXIMAMENTE	
L4	2.4	97 - 99	MOTOR	FRONTAL / DER	PRÓXIMAMENTE	
			TRANSMISIÓN	CENTRAL	A 2874	
			TRANSMISIÓN	TRASERO / IZQ / REPUESTO	982 - A	
			TRANSMISIÓN	FRONTAL / IZQ	PRÓXIMAMENTE	
			TRANSMISIÓN	TRASERO / IZQ	982	
			TRANSMISIÓN	FRONTAL / TRASERO / IZQ / AUT / OVALADO / 4 VEL	1047	
V6	3.1	97 - 98	MOTOR	TORSIÓN / FRONTAL	983	
			TRANSMISIÓN	FRONTAL / TRASERO / IZQ / AUT / OVALADO / 4 VEL	1047	
		97 - 01	MOTOR	FRONTAL / DER	PRÓXIMAMENTE	
			TRANSMISIÓN	CENTRAL	A 2874	
		97 - 03	TRANSMISIÓN	FRONTAL / TRASERO / IZQ / REPUESTO	982 - A	
			TRANSMISIÓN	FRONTAL / IZQ	PRÓXIMAMENTE	
			TRANSMISIÓN	TRASERO / IZQ	982	
		01 - 03	MOTOR	FRONTAL / DER	1015	
V6	3.3	78	MOTOR	FRONTAL / IZQ / 1ra EDICIÓN	A 2383	
		79	TRANSMISIÓN	NOTCHBACK	A 2393	
V6	3.8	78 - 83	MOTOR	FRONTAL / IZQ	A 2382	
			MOTOR	FRONTAL / DER	A 2384	
			TRANSMISIÓN	A 2379		
		80 - 83	MOTOR	FRONTAL / DER / IZQ / MOD. CID 229	919	

919	982	982 - A	983	1008	1015	1047
A2379	A2382	A2383	A2384	A2393	A2874	PRÓXIMAMENTE
PRÓXIMAMENTE	PRÓXIMAMENTE	PRÓXIMAMENTE				











# CHEVROLET

**AUTOS**

MATÍZ	MOTOR	MODELO	SOPORTE	ESPECIFICACIÓN	No. BUFALO
	L4 1.0	00 - 09	MOTOR	FRONTAL / DER / REPUESTO	<b>1093</b>
			TRANSMISIÓN		PRÓXIMAMENTE
		04 - 05	MOTOR	FRONTAL / DER	PRÓXIMAMENTE
			MOTOR		PRÓXIMAMENTE
		06 - 10	TRANSMISIÓN	TRASERO	PRÓXIMAMENTE
			MOTOR	FRONTAL / DER	PRÓXIMAMENTE
		MOTOR	TRASERO	PRÓXIMAMENTE	

						
<b>1093</b>	PRÓXIMAMENTE	PRÓXIMAMENTE	PRÓXIMAMENTE	PRÓXIMAMENTE	PRÓXIMAMENTE	PRÓXIMAMENTE

MERIVA	MOTOR	MODELO	SOPORTE	ESPECIFICACIÓN	No. BUFALO
	L4 1.8	02 - 08	MOTOR	FRONTAL / REPUESTO REFORZADO	<b>1006</b>
			MOTOR	FRONTAL / DER / STD / EASY TRONIC	<b>1046</b>
			MOTOR	FRONTAL / REPUESTO	<b>1079</b>
			MOTOR	TRASERO / COMPLEMENTO	PRÓXIMAMENTE
			MOTOR	TRASERO	PRÓXIMAMENTE
			TRANSMISIÓN	FRONTAL / INF	PRÓXIMAMENTE
			TRANSMISIÓN	IZQ / REPUESTO 1061	<b>1061R</b>
			TRANSMISIÓN	IZQ	<b>1061</b>

						
<b>1006</b>	<b>1046</b>	<b>1061</b>	<b>1061R</b>	<b>1079</b>	PRÓXIMAMENTE	PRÓXIMAMENTE
						
PRÓXIMAMENTE						

MONTECARLO	MOTOR	MODELO	SOPORTE	ESPECIFICACIÓN	No. BUFALO
	V6 3.1	95 - 99	MOTOR	FRONTAL / INF / DER / IZQ / BRACKET RADIADOR	<b>A2901</b>
			MOTOR	FRONTAL / DER	<b>A2796HY</b>
			MOTOR	TORSIÓN / FRONTAL / DER / IZQ	<b>A2866</b>
			TRANSMISIÓN		<b>A2712</b>

CONTINÚA...

MONTECARLO					
V6	3.4	95 - 97	MOTOR	FRONTAL / DER	<b>A2555</b>
			MOTOR	TORSIÓN / FRONTAL	<b>A2799</b>
		00 - 05	TRANSMISIÓN		<b>A2712</b>
			MOTOR	FRONTAL / INF / DER / IZQ / BRACKET RADIADOR	<b>A2901</b>
			MOTOR	FRONTAL / DER	<b>A2796HY</b>
MOTOR	TORSIÓN / FRONTAL / DER / IZQ	<b>A2866</b>			
V6	3.3	78	MOTOR	FRONTAL / IZQ / 1ra EDICIÓN / MOT. 3.3	<b>A2383</b>
		78 - 87	MOTOR	FRONTAL / IZQ	<b>A2382</b>
	MOTOR		FRONTAL / DER	<b>A2384</b>	
	TRANSMISIÓN			<b>A2379</b>	
V6	3.5	06 - 07	MOTOR	FRONTAL / DER / IZQ / BRACKET RADIADOR	<b>A2899</b>
			MOTOR	FRONTAL / DER	<b>A2796HY</b>
			MOTOR	TORSIÓN / FRONTAL / DER / IZQ	<b>PRÓXIMAMENTE</b>
			TRANSMISIÓN		<b>A2818</b>
V6	3.8	94 - 05	MOTOR	FRONTAL / DER	<b>A2796HY</b>
			MOTOR	FRONTAL / INF / DER / IZQ / BRACKET RADIADOR	<b>A2901</b>
		98 - 05	MOTOR	TORSIÓN / FRONTAL / DER / IZQ	<b>A2866</b>
			TRANSMISIÓN		<b>A2712</b>
			MOTOR	FRONTAL / INF / DER / IZQ / BRACKET RADIADOR	<b>PRÓXIMAMENTE</b>
V6	3.9	06 - 07	MOTOR	FRONTAL / DER / IZQ / BRACKET RADIADOR	<b>PRÓXIMAMENTE</b>
			MOTOR	FRONTAL / DER	<b>A2796HY</b>
			MOTOR	TORSIÓN / FRONTAL / DER / IZQ	<b>A2899</b>
			TRANSMISIÓN		<b>A2712</b>
V8	5.3	06 - 07	MOTOR	FRONTAL	<b>PRÓXIMAMENTE</b>
			MOTOR	FRONTAL / DER / IZQ / BRACKET RADIADOR	<b>PRÓXIMAMENTE</b>
			MOTOR	TORSIÓN / FRONTAL / DER / IZQ	<b>A2899</b>
			TRANSMISIÓN		<b>PRÓXIMAMENTE</b>

<b>A2379</b>	<b>A2382</b>	<b>A2383</b>	<b>A2384</b>	<b>A2555</b>	<b>A2712</b>	<b>A2796HY</b>
<b>A2799</b>	<b>A2818</b>	<b>A2866</b>	<b>A2899</b>	<b>A2901</b>	<b>PRÓXIMAMENTE</b>	<b>PRÓXIMAMENTE</b>



# CHEVROLET

---

**AUTOS**

<b>MONTECARLO</b>		
	PRÓXIMAMENTE	PRÓXIMAMENTE

OPTRA	MOTOR	MODELO	SOPORTE	ESPECIFICACIÓN	No. BUFALO
<b>L4</b>	<b>2.0</b>	<b>06 - 10</b>	MOTOR	FRONTAL / DER	PRÓXIMAMENTE
			MOTOR	TORSIÓN / TRASERO	PRÓXIMAMENTE
			TRANSMISIÓN	REPUESTO	PRÓXIMAMENTE
			TRANSMISIÓN		PRÓXIMAMENTE

PRÓXIMAMENTE	PRÓXIMAMENTE	PRÓXIMAMENTE	PRÓXIMAMENTE









PARK AVENUE "BUICK"	MOTOR	MODELO	SOPORTE	ESPECIFICACIÓN	No. BUFALO
<b>V6</b>	<b>3.8</b>	<b>91 - 93</b>	TRANSMISIÓN	FRONTAL / IZQ	<b>A2800</b>
			TRANSMISIÓN	TORSIÓN / TRASERO	<b>A2823HY</b>
		<b>91 - 96</b>	MOTOR	REPUESTO	<b>A2801</b>
			MOTOR		<b>A2799</b>
		<b>94 - 96</b>	TRANSMISIÓN		<b>A2881</b>
			TRANSMISIÓN		<b>A2283</b>
		<b>99 - 05</b>	TRANSMISIÓN	FRONTAL / IZQ	<b>A2698</b>
			TRANSMISIÓN	TRASERO / IZQ	PRÓXIMAMENTE
		<b>00 - 03</b>	MOTOR	FRONTAL / DER	PRÓXIMAMENTE
			TRANSMISIÓN	CENTRAL	PRÓXIMAMENTE

<b>A2283</b>	<b>A2698</b>	<b>A2799</b>	<b>A2800</b>	<b>A2801</b>	<b>A2823HY</b>	<b>A2881</b>
PRÓXIMAMENTE	PRÓXIMAMENTE	PRÓXIMAMENTE				





REGAL "BUICK"	MOTOR	MODELO	SOPORTE	ESPECIFICACIÓN	No. BUFALO
V6	2.8	88 - 93	MOTOR	FRONTAL / DER	<b>A2796HY</b>
	3.1		MOTOR	TORSIÓN / FRONTAL	<b>A2609</b>
			TRANSMISIÓN		<b>PRÓXIMAMENTE</b>

V6	3.1	94 - 96	MOTOR	FRONTAL / INF / DER / IZQ / BRACKET RADIADOR	<b>A2901</b>
			MOTOR	FRONTAL / DER	<b>A2796HY</b>
			MOTOR	TORSIÓN / FRONTAL / DER / IZQ	<b>A2866</b>
			TRANSMISIÓN		<b>A2712</b>

V6	3.8	90 - 93	TRANSMISIÓN		<b>PRÓXIMAMENTE</b>
		90 - 95	MOTOR	FRONTAL / DER	<b>A2556</b>
			MOTOR	TORSIÓN / FRONTAL	<b>A2609</b>
		94 - 96	TRANSMISIÓN		<b>A2712</b>
		96 - 04	MOTOR	FRONTAL / INF / DER / IZQ / BRACKET RADIADOR	<b>PRÓXIMAMENTE</b>
			MOTOR	FRONTAL / DER	<b>A2796HY</b>
			MOTOR	TORSIÓN / FRONTAL / DER / IZQ	<b>A2866</b>
		97 - 04	TRANSMISIÓN		<b>A2818</b>

						
<b>A2556</b>	<b>A2609</b>	<b>A2712</b>	<b>A2796HY</b>	<b>A2818</b>	<b>A2866</b>	<b>A2901</b>
						
<b>PRÓXIMAMENTE</b>	<b>PRÓXIMAMENTE</b>					

REGENCY "OLSDMOBILE"	MOTOR	MODELO	SOPORTE	ESPECIFICACIÓN	No. BUFALO
V6	3.8	97 - 98	MOTOR	FRONTAL	<b>A2801</b>
			MOTOR	TORSIÓN / FRONTAL	<b>A2799</b>
			TRANSMISIÓN	FRONTAL / IZQ	<b>A2881</b>
			TRANSMISIÓN	TRASERO / IZQ	<b>A2283</b>

			
<b>A2283</b>	<b>A2799</b>	<b>A2801</b>	<b>A2881</b>



# CHEVROLET

**AUTOS**

RIVERA "BUICK"	MOTOR	MODELO	SOPORTE	ESPECIFICACIÓN	No. BUFALO
V6 3.8	88 - 93	MOTOR	TORSIÓN / FRONTAL	<b>A 2799</b>	
			TRANSMISIÓN	<b>836</b>	
	89 - 91	TRANSMISIÓN	TRASERO / IZQ	<b>PRÓXIMAMENTE</b>	



SEVILLE "CADILLAC"	MOTOR	MODELO	SOPORTE	ESPECIFICACIÓN	No. BUFALO
V8 4.5	88 - 91	MOTOR	TORSIÓN / FRONTAL	<b>794</b>	
		MOTOR	TORSIÓN / FRONTAL / <i>REPUESTO 794</i>	<b>794-R</b>	
		TRANSMISIÓN	IZQ	<b>836</b>	

V8 4.6	93 - 96	TRANSMISIÓN	FRONTAL / IZQ	<b>PRÓXIMAMENTE</b>
		MOTOR	FRONTAL / DER	<b>A 2838</b>
	93 - 97	TRANSMISIÓN	DER	<b>PRÓXIMAMENTE</b>
		MOTOR	TORSIÓN / FRONTAL / IZQ	<b>A 2781</b>
	93 - 99	MOTOR	FRONTAL / DER	<b>A 2780</b>
		TRANSMISIÓN	IZQ	<b>PRÓXIMAMENTE</b>
	97	MOTOR	DER	<b>PRÓXIMAMENTE</b>
	98 - 99	TRANSMISIÓN	CENTRAL	<b>A 2836</b>

V8 4.9	92 - 93	MOTOR	FRONTAL / DER	<b>A 2836</b>
		TRANSMISIÓN	IZQ	<b>PRÓXIMAMENTE</b>



SKYLARK "BUICK"	MOTOR	MODELO	SOPORTE	ESPECIFICACIÓN	No. BUFALO
L4	2.3	88 - 91	MOTOR	FRONTAL / DER	PRÓXIMAMENTE
			TRANSMISIÓN	STD	936
		92 - 95	MOTOR	FRONTAL / DER	931
			MOTOR	TORSIÓN / INF	983-A
		93 - 95	TRANSMISIÓN	REPUESTO A2715	981
			TRANSMISIÓN		A2715
L4	2.4	96 - 98	MOTOR	FRONTAL / DER	981
			MOTOR	TORSIÓN / FRONTAL	983
			TRANSMISIÓN	REPUESTO A2715	981
			TRANSMISIÓN		A2715
L4	2.5	80 - 85	MOTOR	TORSIÓN / FRONTAL / REPUESTO 794	794-R
			MOTOR	TORSIÓN / FRONTAL	794
			TRANSMISIÓN	FRONTAL / IZQ	804
			TRANSMISIÓN	TRASERO / IZQ	805
		82 - 84	MOTOR	FRONTAL / DER	824
			MOTOR	FRONTAL / DER	836
		85	TRANSMISIÓN		A2783
			85 - 91	MOTOR	TRASERO / DER
		MOTOR		FRONTAL / DER / AUT	890
		MOTOR		FRONTAL / DER / STD	890-A
		MOTOR		TORSIÓN / FRONTAL	882
		TRANSMISIÓN		REPUESTO A2601	866
		TRANSMISIÓN		A2601	
V6	2.8	80 - 85	MOTOR	TORSIÓN / FRONTAL / REPUESTO 794	794-R
			MOTOR	TORSIÓN / FRONTAL	794
			TRANSMISIÓN	FRONTAL / IZQ	804
			TRANSMISIÓN	TRASERO / IZQ	805
		82 - 84	MOTOR	FRONTAL / DER	824
			MOTOR	FRONTAL / DER	836
		85	MOTOR	FRONTAL / DER	836
V6	3.0	86 - 88	MOTOR	FRONTAL / DER	A2626
			MOTOR	TRASERO / DER	899
			MOTOR	TORSIÓN / TRASERO	882
			TRANSMISIÓN	REPUESTO A2601	866
			TRANSMISIÓN		A2601
V6	3.1	86 - 88	MOTOR	TORSIÓN / FRONTAL	983-A
			MOTOR	FRONTAL / DER	931
		94 - 98	TRANSMISIÓN	REPUESTO A2715	981
			TRANSMISIÓN		A2715
		95 - 98	MOTOR	TORSIÓN / FRONTAL	983



# CHEVROLET

**AUTOS**

SKYLARK "BUICK"		V6 3.3	89 - 91	MOTOR	FRONTAL / DER	A2626
						MOTOR
				MOTOR	TORSIÓN / TRASERO	882
				TRANSMISIÓN	REPUESTO A2601	866
				TRANSMISIÓN		A2601
			92 - 93	MOTOR	FRONTAL / DER	931
				MOTOR	TORSIÓN / FRONTAL	983-A
				TRANSMISIÓN	REPUESTO A2715	981
				TRANSMISIÓN		A2715

794	794-R	804	805	824	836	866
882	890	899	931	936	981	983
983-A	A2601	A2626	A2715	A2783	PRÓXIMAMENTE	

SUNFIRE "PONTIAC"		MOTOR	MODELO	SOPORTE	ESPECIFICACIÓN	No. BUFALO
L4	2.2	95 - 05	MOTOR	FRONTAL / DER / REPUESTO	931	
			MOTOR	TORSIÓN / FRONTAL	983	
			TRANSMISIÓN	AUT / REPUESTO A2715	981	
			TRANSMISIÓN	AUT	A2715	
	2.3	95 - 05	TRANSMISIÓN	AUT	PRÓXIMAMENTE	
			TRANSMISIÓN	AUT	PRÓXIMAMENTE	
	2.4	95 - 05	TRANSMISIÓN	FRONTAL / IZQ / STD / 5 VEL / REPUESTO	936	
			TRANSMISIÓN	TRASERO / IZQ / STD / 5 VEL / REPUESTO	936	
		02 - 05	MOTOR	FRONTAL / DER	PRÓXIMAMENTE	

931	936	981	983	A2715	PRÓXIMAMENTE	PRÓXIMAMENTE



TERRAZA	MOTOR	MODELO	SOPORTE	ESPECIFICACIÓN	No. BUFALO
"BUICK"	V6 3.9	95 - 05	MOTOR	FRONTAL / DER / IZQ / BRACKET RADIADOR	PRÓXIMAMENTE
			MOTOR	FRONTAL / DER	A2796HY
			MOTOR	TORSIÓN / FRONTAL / DER / IZQ	A2899
			TRANSMISIÓN		A2818

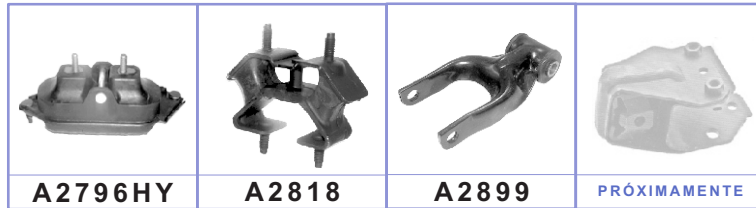

TORONADO	MOTOR	MODELO	SOPORTE	ESPECIFICACIÓN	No. BUFALO
	V6 3.8	88 - 93	MOTOR	TORSIÓN / FRONTAL / REPUESTO 794	794-R
			MOTOR	TORSIÓN / FRONTAL	794
		89 - 91	TRANSMISIÓN	IZQ	836



VECTRA	MOTOR	MODELO	SOPORTE	ESPECIFICACIÓN	No. BUFALO
	L4 L6	03 - 07	MOTOR	FRONTAL / DER	PRÓXIMAMENTE
			MOT / TRANS	TRASERO / REPUESTO	PRÓXIMAMENTE
			MOTOR	TRASERO	PRÓXIMAMENTE
			TRANSMISIÓN	FRONTAL / INF / AUT	PRÓXIMAMENTE
			TRANSMISIÓN	FRONTAL / INF / STD	PRÓXIMAMENTE
			TRANSMISIÓN	SUPERIOR	PRÓXIMAMENTE
			TRANSMISIÓN	SUPERIOR	PRÓXIMAMENTE
			TRANSMISIÓN	SUPERIOR	PRÓXIMAMENTE





# CHEVROLET

**AUTOS**

ZAFIRA	MOTOR	MODELO	SOPORTE	ESPECIFICACIÓN	No. BUFALO
L4	1.8	00 - 03	MOTOR	FRONTAL / REPUESTO A4381-A	<b>1007</b>
			MOTOR	FRONTAL / AUT / MOT. 2.2	PRÓXIMAMENTE
			MOTOR	FRONTAL / AUT / MOT. 1.8	<b>A4381-A</b>
			MOTOR	FRONTAL / DER / STD	<b>A4378</b>
	2.2		TRANSMISIÓN	FRONTAL / INF / STD / MOT. 1.8	<b>A4380</b>
			TRANSMISIÓN	FRONTAL / INF / MOT. 2.2	PRÓXIMAMENTE
			TRANSMISIÓN	TRASERO	<b>1016</b>
			TRANSMISIÓN	AUT / STD / REPUESTO A4381	<b>1005</b>
			TRANSMISIÓN	AUT / STD	<b>A4381</b>
L4	2.0	04 - 06	MOTOR	FRONTAL / DER / AUT / REPUESTO A4381-A	<b>1007</b>
			MOTOR	FRONTAL / DER / AUT	<b>A4381-A</b>
			MOTOR	FRONTAL / DER	<b>A4378</b>
			TRANSMISIÓN	FRONTAL / INF / STD	<b>A4380</b>
	2.4		TRANSMISIÓN	FRONTAL / INF / AUT	<b>A4381-A</b>
			TRANSMISIÓN	TRASERO	<b>1016</b>
			TRANSMISIÓN	FRONTAL / REPUESTO 1014	<b>1079</b>
			TRANSMISIÓN	FRONTAL	<b>1014</b>

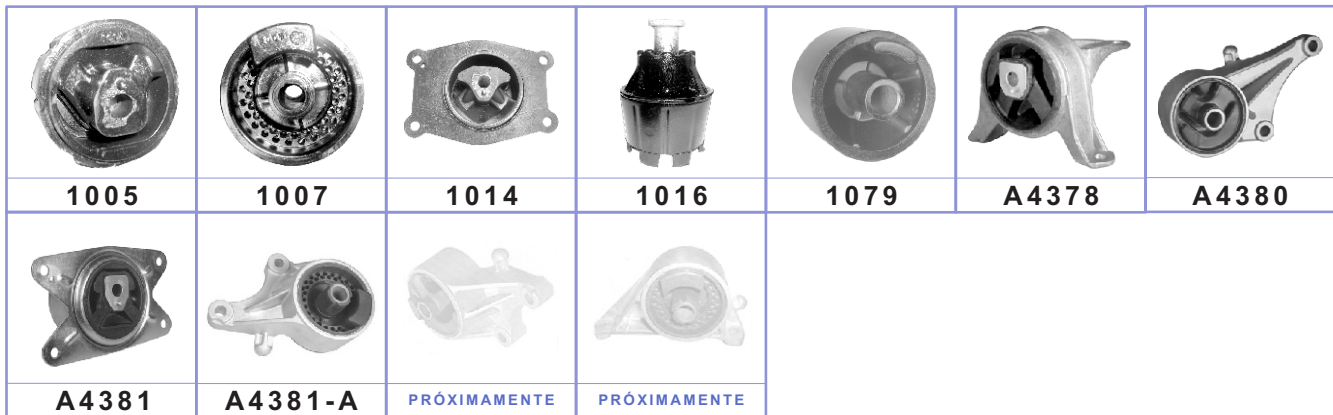

# CALIDAD Y GARANTÍA DE EXPORTACIÓN

AZTEK	MOTOR	MODELO	SOPORTE	ESPECIFICACIÓN	No. BUFALO
V6 3.4	01 - 05	MOTOR	FRONTAL / INF / DER / IZQ / BRACKET RADIADOR	<b>A2900</b>	
		MOTOR	FRONTAL / DER	<b>A2796HY</b>	
		MOTOR	TORSIÓN / FRONTAL	<b>A2899</b>	
		TRANSMISIÓN	<b>A2818</b>		

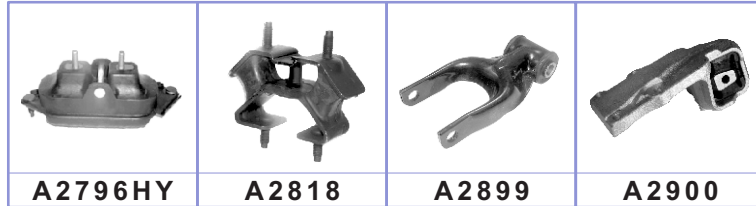

BLAZER	MOTOR	MODELO	SOPORTE	ESPECIFICACIÓN	No. BUFALO
L4 1.9	82 - 83	TRANSMISIÓN	<b>A2771</b>		
L4 2.2	82 - 90	MOTOR	FRONTAL / IZQ	<b>A2549</b>	
		MOTOR	FRONTAL / DER	<b>A2550</b>	
		TRANSMISIÓN	<b>A2638</b>		
	83 - 94	MOTOR	FRONTAL / IZQ	<b>A2755</b>	
		MOTOR	FRONTAL / DER	<b>A2756</b>	
		TRANSMISIÓN	TRASERO / DER / IZQ	<b>A2797HY</b>	
95 - 03	MOTOR	FRONTAL / DER / IZQ	<b>933</b>		
V6 2.8	92 - 98	MOTOR	FRONTAL / DER / IZQ	<b>919</b>	
		TRANSMISIÓN	2 X 2	<b>896</b>	
V6 3.0	70 - 80	MOTOR	FRONTAL / DER / IZQ	<b>5206</b>	
	75 - 91	TRANSMISIÓN	<b>A2393</b>		
	88 - 98	TRANSMISIÓN	TRASERO	<b>991</b>	
		MOTOR	FRONTAL / DER / IZQ	<b>A2637</b>	
	95 - 98	MOTOR	FRONTAL / DER / IZQ	<b>985</b>	
V6 4.3	92 - 98	MOTOR	FRONTAL / DER / IZQ	<b>1122-A</b>	

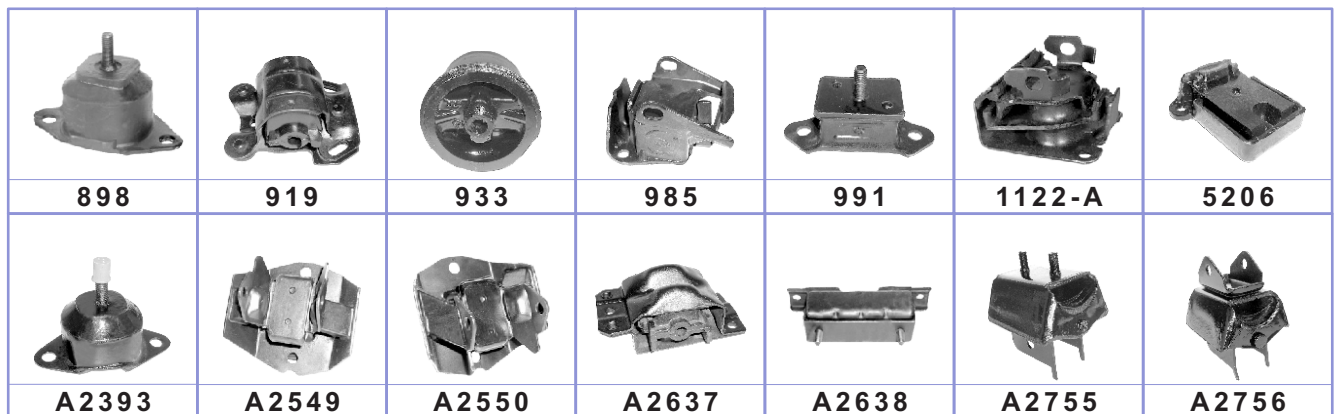



CONTINÚA...







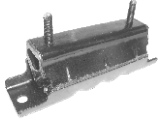

# CHEVROLET

**TODO TERRENO**

<b>BLAZER</b>		
	<b>A2771</b>	<b>A2797HY</b>

<b>BRAVADA</b>	MOTOR	MODELO	SOPORTE	ESPECIFICACIÓN	No. BUFALO
<b>"OLDSMOBILE"</b>	L6 4.2	02 - 04	MOTOR	FRONTAL / DER / IZQ	<b>A2698</b>
			TRANSMISIÓN		<b>885</b>
V6 4.3		91 - 94	MOTOR	BARRA TORSIÓN / DER / IZQ	<b>A2797HY</b>
			TRANSMISIÓN	AUT	<b>A2638</b>
		91 - 95	MOTOR	FRONTAL / DER / IZQ	<b>985</b>
			TRANSMISIÓN	AUT / 4 VEL.	<b>A2638</b>
96 - 01	MOTOR	FRONTAL / DER / IZQ	<b>A2802</b>		

					
<b>885</b>	<b>985</b>	<b>A2638</b>	<b>A2698</b>	<b>A2797HY</b>	<b>A2802</b>

<b>EQUINOX</b>	MOTOR	MODELO	SOPORTE	ESPECIFICACIÓN	No. BUFALO
V8 3.4	05 - 08	MOTOR	FRONTAL / REPUESTO	<b>PRÓXIMAMENTE</b>	
		MOTOR	FRONTAL	<b>PRÓXIMAMENTE</b>	
		MOTOR	FRONTAL / DER	<b>PRÓXIMAMENTE</b>	
		TRANSMISIÓN	REPUESTO	<b>PRÓXIMAMENTE</b>	
		TRANSMISIÓN		<b>PRÓXIMAMENTE</b>	
		TRANSMISIÓN	SUPERIOR / AUT / 5 VEL.	<b>PRÓXIMAMENTE</b>	

				
<b>PROXIMAMENTE</b>	<b>PROXIMAMENTE</b>	<b>PROXIMAMENTE</b>	<b>PROXIMAMENTE</b>	<b>PROXIMAMENTE</b>

<b>ESCALADE</b>	MOTOR	MODELO	SOPORTE	ESPECIFICACIÓN	No. BUFALO
<b>"CADILLAC"</b>	V8 5.3	02 - 05	MOTOR	FRONTAL / DER / IZQ	<b>1057</b>
			TRANSMISIÓN	4 X 2	<b>930</b>
			TRANSMISIÓN	4 X 4	<b>A2638</b>

CONTINÚA...

# CHEVROLET

**TODO TERRENO**



ESCALADE		MOTOR	MODELO	SOPORTE	ESPECIFICACIÓN	No. BUFALO
"CADILLAC"		V8 5.7	99 - 00	MOTOR	FRONTAL / DER / IZQ	<b>A 2637</b>
				TRANSMISIÓN	2 X 2	<b>930</b>
				TRANSMISIÓN	4 X 4	<b>A 2638</b>
V8 6.0	02 - 06	MOTOR	FRONTAL / DER / IZQ	<b>1057</b>		
		TRANSMISIÓN	4 X 2	<b>930</b>		
	02 - 10	TRANSMISIÓN	4 X 4	<b>A 2638</b>		
				<b>PRÓXIMAMENTE</b>		
07 - 10	MOTOR	FRONTAL / DER / IZQ	<b>PRÓXIMAMENTE</b>			
V8 6.2	02 - 06	MOTOR	FRONTAL / DER / IZQ	<b>PRÓXIMAMENTE</b>		



RENDEZVOUS		MOTOR	MODELO	SOPORTE	ESPECIFICACIÓN	No. BUFALO
"BUICK"		V6 3.4 3.5 3.6	02 - 07	MOTOR	FRONTAL / INF / DER / IZQ / BRACKET RADIADOR	<b>A 2900</b>
				MOTOR	FRONTAL / DER	<b>A 2796HY</b>
				MOTOR	TORSIÓN / DER	<b>A 2899</b>
				TRANSMISIÓN	AUT / 4 VEL.	<b>A 2818</b>

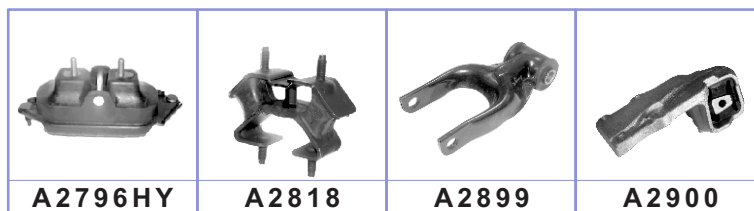

S-10 / BLAZER		MOTOR	MODELO	SOPORTE	ESPECIFICACIÓN	No. BUFALO
S-15 / JIMMY		L4 1.9	82 - 85	MOTOR	FRONTAL / DER / IZQ	<b>A 2381</b>
			83	TRANSMISIÓN		<b>A 2771</b>
			83 - 84	TRANSMISIÓN	4 X 4	<b>A 2638</b>
			84	TRANSMISIÓN	2 X 2	<b>930</b>
L4 2.0	83 - 84	TRANSMISIÓN	2 X 2	<b>930</b>		
		TRANSMISIÓN	4 X 4	<b>A 2638</b>		
L4 2.2	83 - 95	MOTOR	FRONTAL / IZQ	<b>A 2549</b>		
		MOTOR	FRONTAL / DER	<b>A 2550</b>		
		TRANSMISIÓN		<b>930</b>		

CONTINÚA...



# CHEVROLET

**TODO TERRENO**

S-10 / BLAZER S-15 / JIMMY		MOTOR	MODELO	SOPORTE	ESPECIFICACIÓN	No. BUFALO
L4	2.2		94 - 97	TRANSMISIÓN	STD	<b>A2956</b>
				MOTOR	FRONTAL / DER / IZQ / REPUESTO	<b>933</b>
			94 - 03	MOTOR	FRONTAL / IZQ	PRÓXIMAMENTE
				MOTOR	FRONTAL / DER	PRÓXIMAMENTE
				TRANSMISIÓN	AUT	<b>A2957</b>
			98 - 03	TRANSMISIÓN	STD / 5 VEL.	<b>A2957</b>
L4	2.5		85 - 87	TRANSMISIÓN	2 X 2	<b>930</b>
				MOTOR	FRONTAL / IZQ	<b>A2549</b>
			85 - 93	MOTOR	FRONTAL / DER	<b>A2550</b>
				TRANSMISIÓN	4 X 4	<b>A2638</b>
			88 - 93	TRANSMISIÓN	2 X 2	<b>898</b>
V6	2.8		82	TRANSMISIÓN		<b>A2771</b>
				MOTOR	FRONTAL / DER / IZQ	<b>919</b>
			82 - 93	MOTOR	BARRA TORSIÓN	<b>A2797HY</b>
				MOTOR	4 X 4	<b>A2638</b>
			83 - 97	TRANSMISIÓN	2 X 2	<b>930</b>
			88 - 93	TRANSMISIÓN	2 X 2	<b>A2393</b>
V6	3.0	95 - 98	MOTOR	FRONTAL / DER / IZQ	<b>985</b>	
V6	4.3		88 - 94	MOTOR	BARRA TORSIÓN / 4 X 4	<b>A2797</b>
				TRANSMISIÓN	2 X 2	<b>A2393</b>
			88 - 95	MOTOR	FRONTAL / DER / IZQ	<b>930</b>
				TRANSMISIÓN	TRASERO	<b>991</b>
			88 - 04	TRANSMISIÓN	4 X 4	<b>A2638</b>
			96 - 05	MOTOR	FRONTAL / DER / IZQ	<b>A1122-A</b>
TRANSMISIÓN		<b>930</b>				

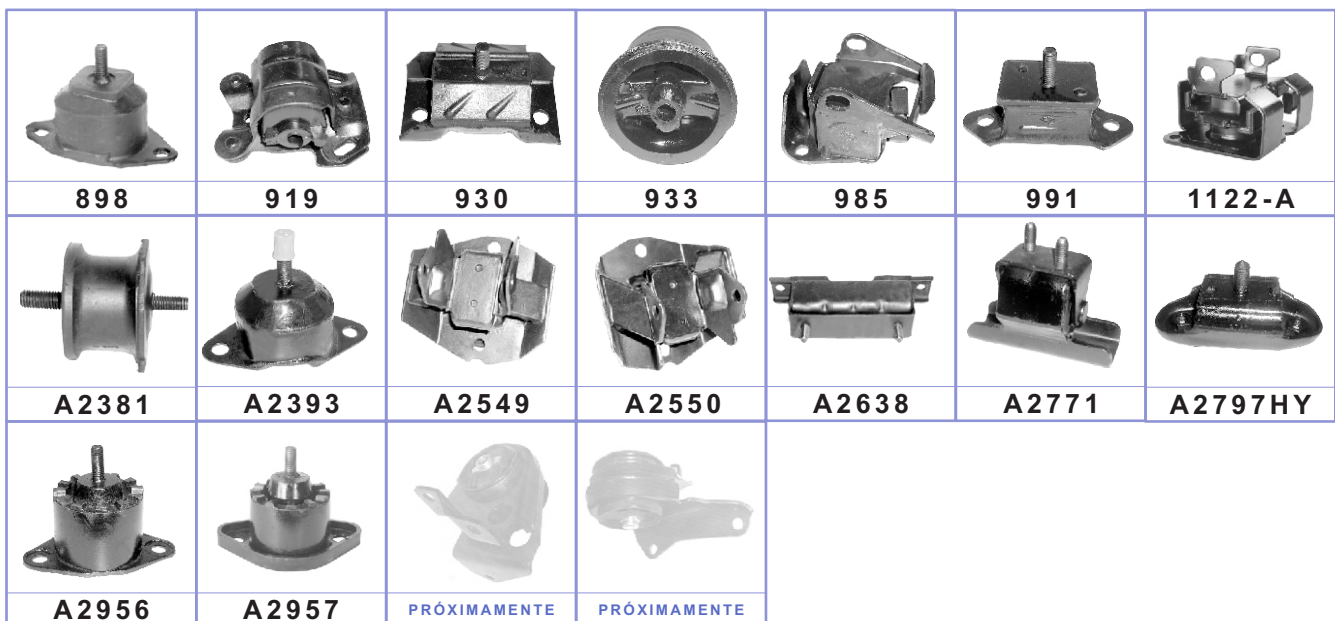

# CHEVROLET

**TODO TERRENO**



SONORA MEX TAHOE / YUKON DENALI		MOTOR	MODELO	SOPORTE	ESPECIFICACIÓN	No. BUFALO
V6	4.3	07 - 10	MOTOR	FRONTAL / DER / IZQ	1131-A	
			TRANSMISIÓN		930	
V8	4.8	00 - 07	MOTOR	FRONTAL / DER / IZQ / MOTOR VORTEC	1057	
			TRANSMISIÓN	2 X 2	930	
			TRANSMISIÓN	4 X 4	A2638	
	5.3	07 - 10	MOTOR	FRONTAL / DER / IZQ	PRÓXIMAMENTE	
			TRANSMISIÓN	4 X 2	930	
			TRANSMISIÓN	4 X 4	A2638	
V8	5.7	00 - 07	TRANSMISIÓN	2 X 2	711	
			MOTOR	FRONTAL / DER / IZQ / 4 X 4	A2637	
			MOTOR	FRONTAL / DER / IZQ / 2 X 2	846	
			TRANSMISIÓN	4 X 4	A2638	
			TRANSMISIÓN	2 X 2	PRÓXIMAMENTE	
	00	MOTOR	FRONTAL / DER / IZQ / MOTOR VORTEC	1057		
V8	6.0	00 - 07	MOTOR	FRONTAL / DER / IZQ	1057	
			TRANSMISIÓN	2 X 2	930	
		92 - 00	TRANSMISIÓN	4 X 4	A2638	
			MOTOR	FRONTAL / DER / IZQ	PRÓXIMAMENTE	
V8	6.2	07 - 10	MOTOR	FRONTAL / DER / IZQ	PRÓXIMAMENTE	
V8	6.5	94 - 98	MOTOR	FRONTAL / DER / IZQ / 4 X 4	A2637	
			MOTOR	FRONTAL / DER / IZQ / 2 X 2	846	
			TRANSMISIÓN	4 X 4	A2638	
			TRANSMISIÓN	2 X 2	PRÓXIMAMENTE	

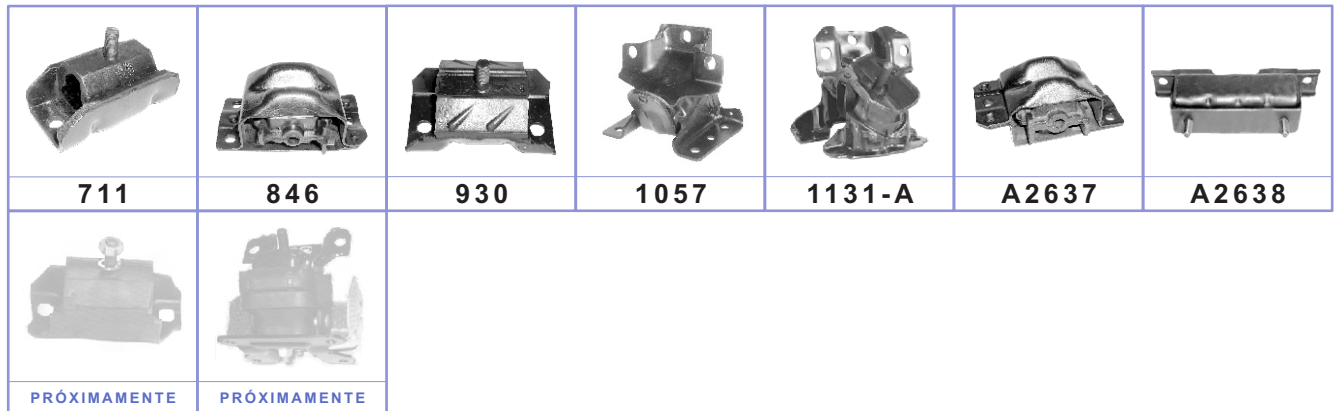



# CHEVROLET

**TODO TERRENO**

SUBURBAN			MOTOR	MODELO	SOPORTE	ESPECIFICACIÓN	No. BUFALO
V6	4.3	07 - 10	MOTOR			FRONTAL / DER / IZQ	1131-A
			TRANSMISIÓN				930
V8	4.8	07 - 10	MOTOR			FRONTAL / DER / IZQ	PRÓXIMAMENTE
			TRANSMISIÓN			4 X 2	930
			TRANSMISIÓN			4 X 4	A2638
V8	5.0	68 - 72	MOTOR			FRONTAL / DER / IZQ	5206
		72 - 91	MOTOR			FRONTAL / DER / IZQ	722
		73 - 81	TRANSMISIÓN			AUT / 3 VEL. / STD	223
		73 - 94	TRANSMISIÓN				877
		82 - 87	TRANSMISIÓN			AUT / 3 VEL.	877
		82 - 91	TRANSMISIÓN			AUT / 4 VEL. / STD	898
		85 - 91	TRANSMISIÓN			4 X 4	A2638
		99 - 07	MOTOR			FRONTAL / DER / IZQ	1057
V8	5.3	00 - 07	MOTOR			FRONTAL / DER / IZQ / MOTOR VORTEC	1057
		00 - 10	TRANSMISIÓN			2 X 2 / 4 X 2	930
			TRANSMISIÓN			4 X 4	A2638
		07 - 10	MOTOR			FRONTAL / DER / IZQ	PRÓXIMAMENTE
V8	5.7	92 - 99	MOTOR			FRONTAL / DER / IZQ	846
			MOTOR			FRONTAL / DER / IZQ / 4 X 4	A2637
			TRANSMISIÓN				930
			TRANSMISIÓN			4 X 4	A2638
V8	6.0	00 - 07	MOTOR			FRONTAL / DER / IZQ / MOTOR VORTEC	1057
		00 - 10	TRANSMISIÓN			2 X 2 / 4 X 2	930
			TRANSMISIÓN				A2638
		07 - 10	MOTOR			FRONTAL / DER / IZQ	PRÓXIMAMENTE
V8	6.2	07 - 10	MOTOR			FRONTAL / DER / IZQ	PRÓXIMAMENTE

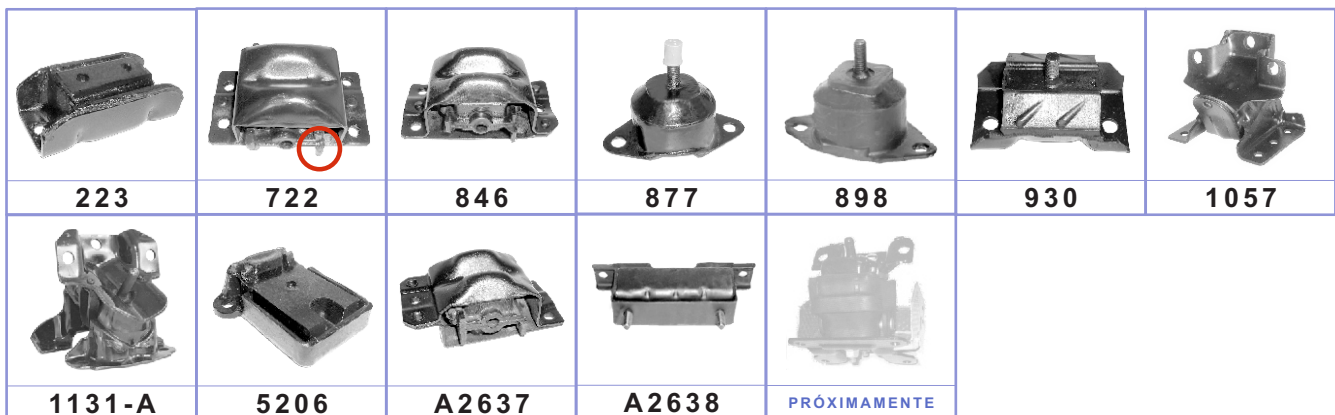



TRACKER		MOTOR	MODELO	SOPORTE	ESPECIFICACIÓN	No. BUFALO
L4	1.6	89 - 98		MOTOR	FRONTAL / DER / IZQ / 2 X 2 / 4 X 4	<b>A 8568</b>
		91 - 98		MOTOR	FRONTAL / DER / IZQ / 2 X 2	<b>A 8569</b>
		98		MOTOR	FRONTAL / DER / IZQ / 2 X 2	<b>1115-A</b>
		89 - 00		TRANSMISIÓN		<b>PRÓXIMAMENTE</b>
L4	2.0	99 - 03		MOTOR	FRONTAL / DER / IZQ	<b>1115-A</b>
				TRANSMISIÓN	AUT	<b>PRÓXIMAMENTE</b>
				TRANSMISIÓN	STD / 5 VEL.	<b>PRÓXIMAMENTE</b>
V6	2.5	06 - 08		MOTOR	FRONTAL / DER / IZQ	<b>1115-A</b>
				TRANSMISIÓN	4 X 4	<b>PRÓXIMAMENTE</b>
				TRANSMISIÓN	TRACCIÓN TRASERA	<b>PRÓXIMAMENTE</b>

<b>1115-A</b>	<b>A8568</b>	<b>A8569</b>	<b>PRÓXIMAMENTE</b>	<b>PRÓXIMAMENTE</b>	<b>PRÓXIMAMENTE</b>

TRAILBLAZER ENVOY		MOTOR	MODELO	SOPORTE	ESPECIFICACIÓN	No. BUFALO
L6	4.2	02 - 08		MOTOR	FRONTAL / DER / IZQ	<b>A 2698</b>
				TRANSMISIÓN		<b>885</b>

<b>885</b>	<b>A2698</b>



MR



# CHEVROLET

PICK UP

AVALANCHE	MOTOR	MODELO	SOPORTE	ESPECIFICACIÓN	No. BUFALO
V8	5.3	02 - 06	MOTOR	FRONTAL / DER / IZQ	<b>1057</b>
			TRANSMISIÓN	2 X 2	<b>930</b>
			TRANSMISIÓN	4 X 4	<b>A2638</b>
		07 - 10	MOTOR	FRONTAL / DER / IZQ	<b>PRÓXIMAMENTE</b>
V8	6.0	07 - 10	MOTOR	FRONTAL / DER / IZQ	<b>PRÓXIMAMENTE</b>

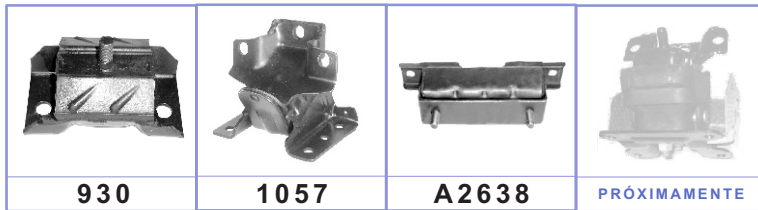

C-10, C-15, C-20 C-1500, C-2500 C-3500	MOTOR	MODELO	SOPORTE	ESPECIFICACIÓN	No. BUFALO	
L6	4.1	63 - 81	TRANSMISIÓN	AUT / 3 VEL. / USA	<b>223 - A</b>	
		66 - 82	TRANSMISIÓN	STD / USA	<b>223</b>	
		70 - 80	MOTOR	FRONTAL / DER / IZQ	<b>5206</b>	
	4.3	73 - 94	MOTOR	FRONTAL / DER / IZQ	<b>722</b>	
		73 - 94	MOTOR	FRONTAL / IZQ / MEX - USA	<b>722 - A</b>	
	TRANSMISIÓN			<b>727</b>		
	TRANSMISIÓN		MOT. 5.0 Y 5.7	<b>5194</b>		
	5.0	82 - 87	TRANSMISIÓN		<b>711</b>	
	5.7	82 - 91	TRANSMISIÓN	V8 / MOT. 6.2	<b>877</b>	
	V8	6.2	82 - 95	TRANSMISIÓN	UNIVERSAL	<b>711</b>
		6.5	82 - 99	TRANSMISIÓN	STD / AUT / 3 Y 4 VEL.	<b>898</b>
				TRANSMISIÓN	MEX - USA	<b>A2393</b>
		8.1	85 - 02	TRANSMISIÓN	4 X 4 / MEX - USA	<b>A2638</b>
		02 - 07	MOTOR	FRONTAL / DER / IZQ	<b>1017 - A</b>	
99 - 03	MOTOR	FRONTAL / DER / IZQ	<b>1057</b>			

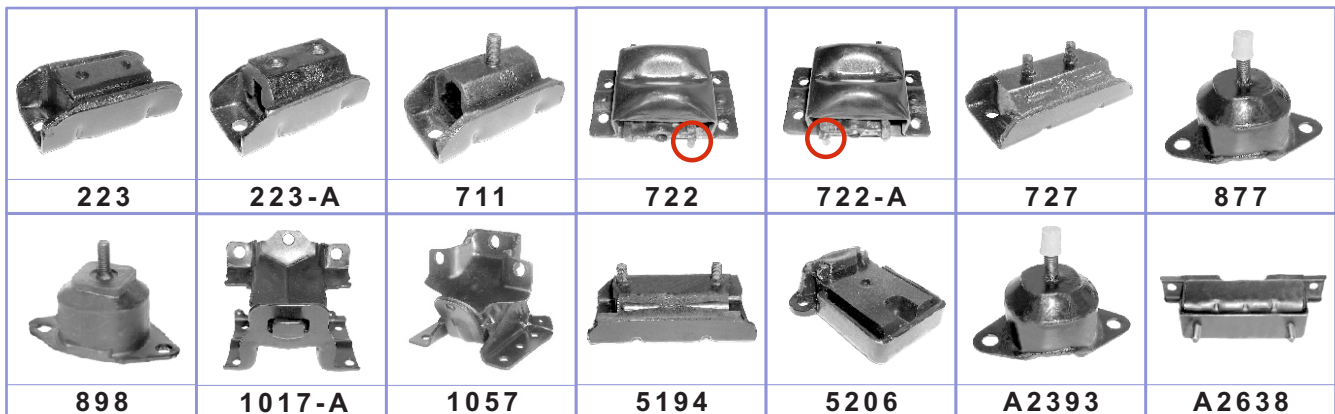

C-30, C-35, C-50 C-75		MOTOR	MODELO	SOPORTE	ESPECIFICACIÓN	No. BUFALO	
L6	4.1	56 - 81	TRANSMISIÓN		SUPERIOR / DER / IZQ	218	
			TRANSMISIÓN		STD / USA	219	
	4.6	63 - 64	MOTOR		DER / IZQ / BASE DE SOPORTE	B 200 - A	
			MOTOR		DER / IZQ / BASE DE SOPORTE	B 200 - B	
		63 - 75	MOTOR		FRONTAL / DER / IZQ	200 - A	
		63 - 80	MOTOR		FRONTAL / DER / IZQ	200 - B	
		70 - 80	MOTOR		FRONTAL / DER / IZQ	5206	
		73 - 91	TRANSMISIÓN		STD	727	
	V8	5.0	70 - 94	MOTOR		FRONTAL / DER	722
		5.7		MOTOR		FRONTAL / IZQ	722 - A
6.2		TRANSMISIÓN			AUT / STD	5194	
6.5		75 - 91	TRANSMISIÓN			A2393	
8.1		92 - 00	MOTOR		FRONTAL / DER / IZQ	846	
	96 - 99	TRANSMISIÓN			877		

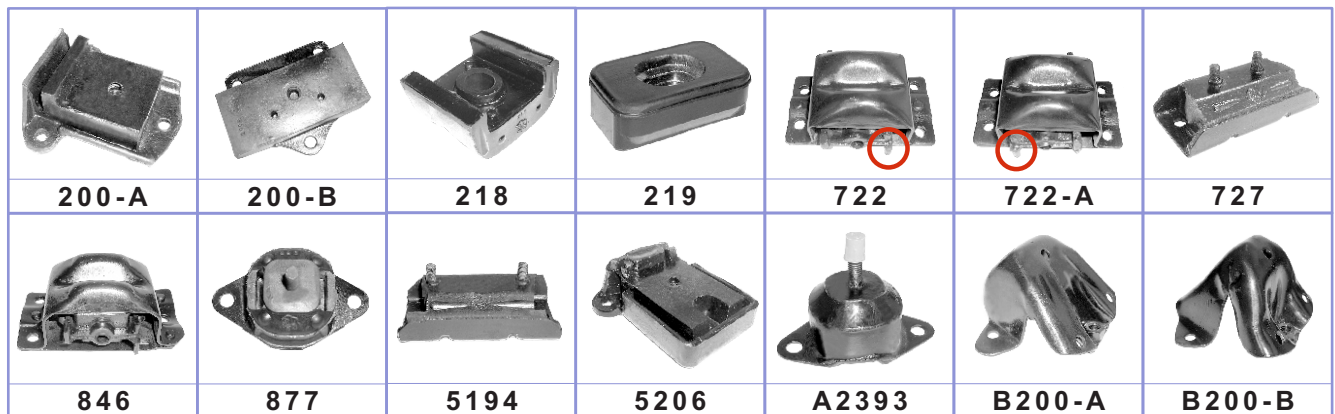

C-3500		MOTOR	MODELO	SOPORTE	ESPECIFICACIÓN	No. BUFALO
V8	5.7	01 - 07	MOTOR		FRONTAL / DER / IZQ	1017 - A
			TRANSMISIÓN			727
			TRANSMISIÓN			A2638

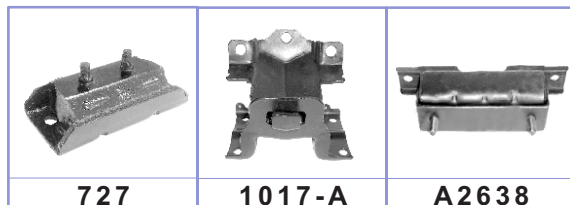



# CHEVROLET

PICK UP

C-3500 / C-4500 HEAVY DUTY	MOTOR	MODELO	SOPORTE	ESPECIFICACIÓN	No. BUFALO
	V8 8.1	02 - 05	MOTOR	FRONTAL / DER / IZQ	1017
			TRANSMISIÓN		727
			TRANSMISIÓN		A2638



CANYON GMC COLORADO	MOTOR	MODELO	SOPORTE	ESPECIFICACIÓN	No. BUFALO
	L4 2.9	05 - 10	MOTOR	FRONTAL / DER / IZQ / REPUESTO	935
			MOTOR		PRÓXIMAMENTE
			MOTOR		PRÓXIMAMENTE
	V6 3.7	05 - 10	TRANSMISIÓN	4 X 2	PRÓXIMAMENTE
			TRANSMISIÓN	4 X 4	A2638



CHEYENNE	MOTOR	MODELO	SOPORTE	ESPECIFICACIÓN	No. BUFALO
	V6 4.3	82 - 97	MOTOR	FRONTAL / DER	722
			MOTOR	FRONTAL / IZQ	722 - A
		07 - 10	MOTOR	FRONTAL / DER / IZQ	1131 - A
			TRANSMISIÓN	4 X 2	930
	V8 4.8	82 - 97	MOTOR	FRONTAL / DER	722
			MOTOR	FRONTAL / IZQ	722 - A
		07 - 10	MOTOR	FRONTAL / DER / IZQ	PRÓXIMAMENTE
			TRANSMISIÓN	4 X 2	930
	V8 6.0	07 - 10		4 X 4	A2638
	V8 6.2	07 - 10	MOTOR	FRONTAL / DER / IZQ	PRÓXIMAMENTE
	V8 6.2	07 - 10	MOTOR	FRONTAL / DER / HEAVY DUTY / TURBO DIESEL	PRÓXIMAMENTE
			MOTOR	FRONTAL / IZQ / HEAVY DUTY / TURBO DIESEL	1017

CONTINÚA...

CHEYENNE						
	722	722-A	930	1017	1131-A	A2638
	PRÓXIMAMENTE	PRÓXIMAMENTE				

LUV PICK UP	MOTOR	MODELO	SOPORTE	ESPECIFICACIÓN	No. BUFALO
L4	1.8	72 - 82	TRANSMISIÓN		A2567

L4	2.3	72 - 82	MOTOR	FRONTAL / DER	A2562
			MOTOR	FRONTAL / IZQ	A2563
		00 - 06	MOTOR	FRONTAL / DER / IZQ	PRÓXIMAMENTE
			TRANSMISIÓN		A8870

A2562	A2563	A2567	A8870	PRÓXIMAMENTE

S-10 / S-15 SONOMA	MOTOR	MODELO	SOPORTE	ESPECIFICACIÓN	No. BUFALO
L4	1.9	82 - 83	TRANSMISIÓN		A2771
			MOTOR	FRONTAL / DER / IZQ	A2381
		82 - 85	TRANSMISIÓN	4 X 4	A2638
			TRANSMISIÓN	2 X 2	930
	2.0	83 - 84	TRANSMISIÓN	AUT	930
			TRANSMISIÓN	STD	A2771
		83 - 84	TRANSMISIÓN		A2638

L4	2.2	83 - 85	MOTOR	FRONTAL / DER	A2550
			MOTOR	FRONTAL / IZQ	A2549
			TRANSMISIÓN		930
		94 - 97	TRANSMISIÓN	STD	A2956
			MOTOR	FRONTAL / DER / IZQ / REPUESTO 1236 Y 1237	933
		88 - 93	MOTOR	FRONTAL / DER	PRÓXIMAMENTE
			MOTOR	FRONTAL / IZQ	PRÓXIMAMENTE
			TRANSMISIÓN	AUT	A2957
		98 - 03	TRANSMISIÓN	STD / 5 VEL.	A2957

CONTINÚA...



# CHEVROLET

PICK UP

S-10 / S-15 SONOMA		MOTOR	MODELO	SOPORTE	ESPECIFICACIÓN	No. BUFALO
L4	2.5	MOTOR	85 - 93		FRONTAL / DER	A2550
			85 - 93		FRONTAL / IZQ	A2549
		TRANSMISIÓN	85 - 87			930
		TRANSMISIÓN	85 - 90		4 X 4	A2638
		TRANSMISIÓN	88 - 93			877

V6	2.8	TRANSMISIÓN	82		AUT / STD	A2771	
			MOTOR		FRONTAL / DER / IZQ	919	
		MOTOR	82 - 93			BARRA DE TORSIÓN	A2797HY
				TRANSMISIÓN		4 X 4	A2638
		TRANSMISIÓN	83 - 98		2 X 2	930	
		TRANSMISIÓN	88 - 93		2 X 2	PRÓXIMAMENTE	

V6	4.3	TRANSMISIÓN	88 - 93		4 X 4	A2638
			MOTOR	88 - 94		BARRA DE TORSIÓN
		TRANSMISIÓN			2 X 2	877
		MOTOR	88 - 95		FRONTAL / DER / IZQ	985
		TRANSMISIÓN	94 - 04		4 X 4	A2639
		TRANSMISIÓN	95 - 04		2 X 2	PRÓXIMAMENTE
		MOTOR	96 - 04		FRONTAL / DER / IZQ	A2802

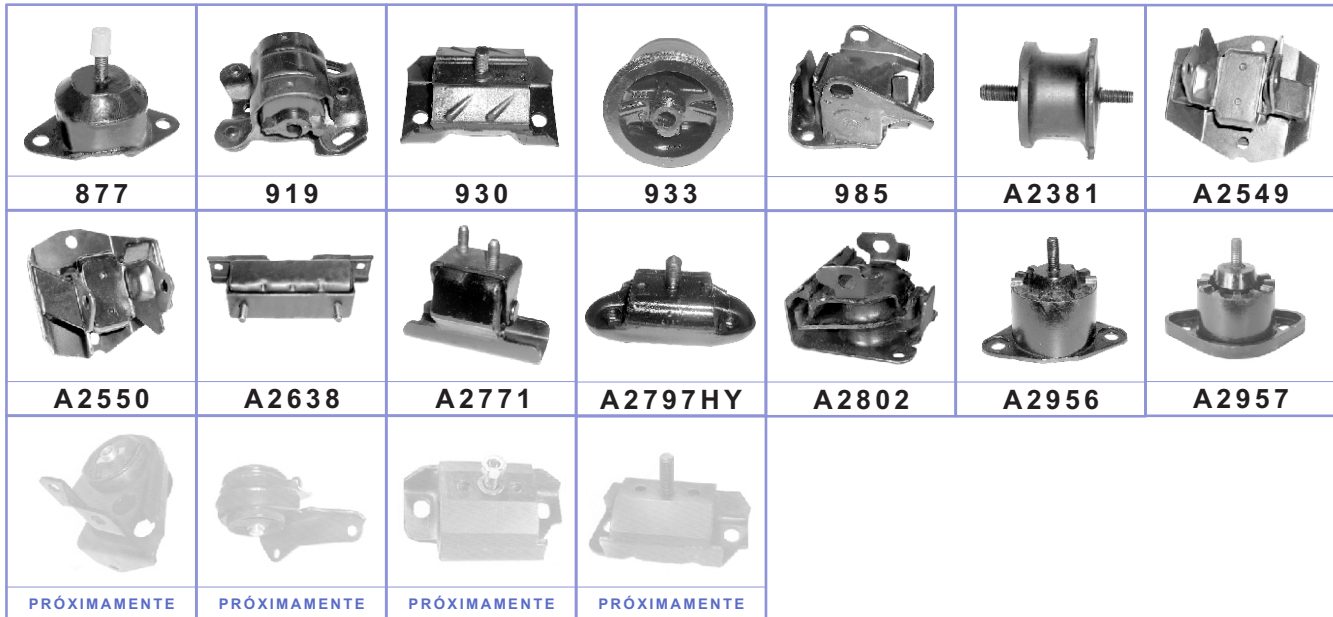

SERIE T T-10 / T-15		MOTOR	MODELO	SOPORTE	ESPECIFICACIÓN	No. BUFALO
V6	4.3	TRANSMISIÓN	76 - 87			A2391
			MOTOR	96 - 01		FRONTAL / DER / IZQ





CONTINÚA...

<b>SERIE T</b> T-10 / T-15		
	<b>1122-A</b>	<b>A2391</b>

SILVERADO	MOTOR	MODELO	SOPORTE	ESPECIFICACIÓN	No. BUFALO
	V6 V8	72 - 94	MOTOR	FRONTAL / DER	<b>722</b>
			MOTOR	FRONTAL / IZQ	<b>722-A</b>
		99 - 07	MOTOR	FRONTAL / DER / IZQ	<b>1057</b>

		
<b>722</b>	<b>722-A</b>	<b>1057</b>

SILVERADO 1500 SIERRA 1500	MOTOR	MODELO	SOPORTE	ESPECIFICACIÓN	No. BUFALO
	V6 4.3	99 - 07	MOTOR	FRONTAL / DER / IZQ	<b>1017-B</b>
			TRANSMISIÓN	TRACCIÓN TRASERA	<b>930</b>
			TRANSMISIÓN	4 X 4	<b>A2638</b>
		07 - 10	MOTOR	FRONTAL / DER / IZQ	<b>1131-A</b>
			TRANSMISIÓN		<b>930</b>

			
<b>930</b>	<b>1017-B</b>	<b>1131-A</b>	<b>A2638</b>

SILVERADO 1500-2500- 3500 SIERRA 1500-2500-3500	MOTOR	MODELO	SOPORTE	ESPECIFICACIÓN	No. BUFALO
	V8 4.8	99 - 07	MOTOR	FRONTAL / DER / IZQ	<b>1057</b>
			TRANSMISIÓN	TRACCIÓN TRASERA	<b>930</b>
			TRANSMISIÓN	4 X 4	<b>A2638</b>
	V8 5.3	07 - 10	MOTOR	FRONTAL / DER / IZQ	<b>PRÓXIMAMENTE</b>
			TRANSMISIÓN	4 X 2	<b>930</b>
			TRANSMISIÓN	4 X 4	<b>A2638</b>
	V8 6.2	07 - 10	MOTOR	FRONTAL / DER / IZQ	<b>PRÓXIMAMENTE</b>
	V8 6.6	07 - 10	MOTOR	FRONTAL / DER / HEAVY DUTY	<b>1057</b>
			MOTOR	FRONTAL / IZQ / HEAVY DUTY	<b>PRÓXIMAMENTE</b>

CONTINÚA...



# CHEVROLET

PICK UP

<b>SILVERADO</b> 1500-2500- 3500 <b>SIERRA</b> 1500-2500-3500					
	<b>930</b>	<b>1057</b>	<b>A2638</b>	PRÓXIMAMENTE	PRÓXIMAMENTE

TORNADO	MOTOR	MODELO	SOPORTE	ESPECIFICACIÓN	No. BUFALO
L4	1.8	04 - 08	MOTOR	FRONTAL / REPUESTO	<b>1006</b>
			MOTOR	FRONTAL / DER / STD / EASY TRONIC	<b>1046</b>
			MOTOR	TRASERO / COMPLEMENTO	PRÓXIMAMENTE
			MOTOR	TRASERO	PRÓXIMAMENTE
			TRANSMISIÓN	FRONTAL / INF	PRÓXIMAMENTE
			TRANSMISIÓN	FRONTAL / IZQ / EASY TRONIC	<b>1061</b>
			TRANSMISIÓN	IZQ / EASY TRONIC / REPUESTO 1061	<b>1061-R</b>

<b>1006</b>	<b>1046</b>	<b>1061</b>	<b>1061-R</b>	PRÓXIMAMENTE	PRÓXIMAMENTE	PRÓXIMAMENTE

# CHEVROLET

CAMIONETAS VAN

ASTRO SAFARI	MOTOR	MODELO	SOPORTE	ESPECIFICACIÓN	No. BUFALO
L4	2.5	85 - 90	MOTOR	FRONTAL / IZQ	<b>A2549</b>
			MOTOR	FRONTAL / DER	<b>A2550</b>
			TRANSMISIÓN		<b>A2393</b>

V6	4.3	85 - 90	TRANSMISIÓN	STD / AUT / 4 VEL.	<b>A2393</b>
		85 - 05	MOTOR	FRONTAL / DER / IZQ	<b>919</b>
		91 - 93	TRANSMISIÓN	AUT / 4 VEL.	PRÓXIMAMENTE
		94 - 05	TRANSMISIÓN	AUT / 4 VEL.	<b>A2880</b>
			TRANSMISIÓN	TRACCIÓN EN 4 RUEDAS	<b>A2638</b>

<b>919</b>	<b>A2393</b>	<b>A2549</b>	<b>A2550</b>	<b>A2638</b>	<b>A2880HY</b>	PRÓXIMAMENTE



EXPRESS VAN SABANA	MOTOR	MODELO	SOPORTE	ESPECIFICACIÓN	No. BUFALO
V6	4.3	72 - 94	TRANSMISIÓN	CARGA PESADA	930
			MOTOR	FRONTAL / DER / IZQ	846
	5.0	96 - 02	TRANSMISIÓN		PRÓXIMAMENTE
			MOTOR		
V8	5.7				
	6.5				
	7.4				
	8.1				

V8	4.8 5.3 6.0	03 - 10	MOTOR	FRONTAL / DER / IZQ	1084
			TRANSMISIÓN		A2638
			TRANSMISIÓN		PRÓXIMAMENTE

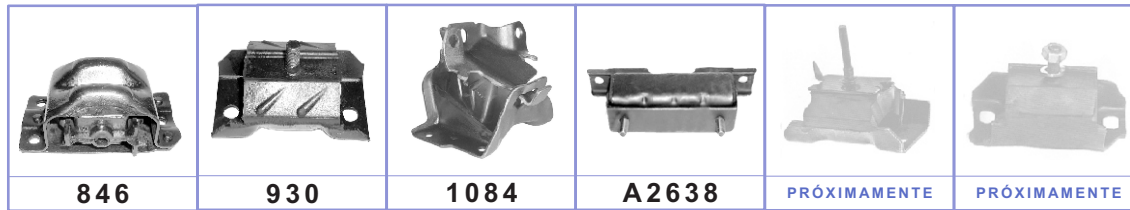

LUMINA ADV	MOTOR	MODELO	SOPORTE	ESPECIFICACIÓN	No. BUFALO
V6	3.1 3.8	90 - 95	MOTOR	FRONTAL / DER	836
			MOTOR	TORSIÓN / FRONTAL / REPUESTO 794	794-R
			MOTOR	TORSIÓN / FRONTAL	794
			TRANSMISIÓN	FRONTAL / IZQ	804
			TRANSMISIÓN	TRASERO / IZQ	805

V6	3.4	96	MOTOR	FRONTAL / DER	836
			MOTOR	TORSIÓN / FRONTAL	A2866
			TRANSMISIÓN	FRONTAL / IZQ	804
			TRANSMISIÓN	TRASERO / IZQ	805

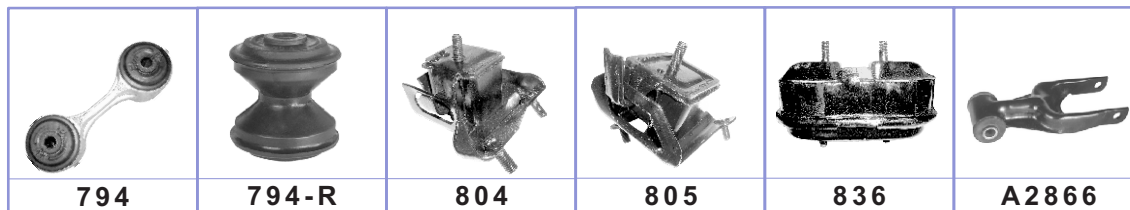

MONTANA	MOTOR	MODELO	SOPORTE	ESPECIFICACIÓN	No. BUFALO
V6	3.4 3.5 3.9	99 - 05	MOTOR	FRONTAL / INF / DER / IZQ / BRACKET RADIADOR	A2900
			MOTOR	FRONTAL / DER	A2796HY
			MOTOR	TORSIÓN / FRONTAL	A2899
			TRANSMISIÓN		A2818

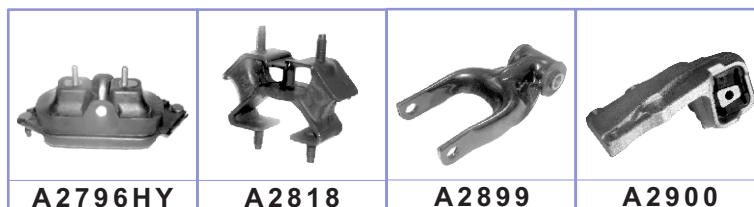



# CHEVROLET

**CAMIONETAS VAN**

SILHOUETTE	MOTOR	MODELO	SOPORTE	ESPECIFICACIÓN	No. BUFALO	
"OLDSMOBILE"	V6	3.1 3.8	90 - 95	MOTOR	FRONTAL	836
				MOTOR	TORSIÓN / FRONTAL / REPUESTO 794	794 - R
				MOTOR	TORSIÓN / FRONTAL	794
				TRANSMISIÓN	FRONTAL / IZQ	804
				TRANSMISIÓN	TRASERO / IZQ	805

V6	3.4	96	MOTOR	FRONTAL	836
			MOTOR	TORSIÓN / FRONTAL	A2866
			TRANSMISIÓN	FRONTAL / IZQ	804
			TRANSMISIÓN	TRASERO / IZQ	805
	97 - 04	MOTOR	FRONTAL / INF / DER / IZQ / BRACKET RADIADOR	A2900	
		MOTOR	FRONTAL	A2796HY	
		MOTOR	TORSIÓN / FRONTAL	A2899	
		TRANSMISIÓN		A2818	

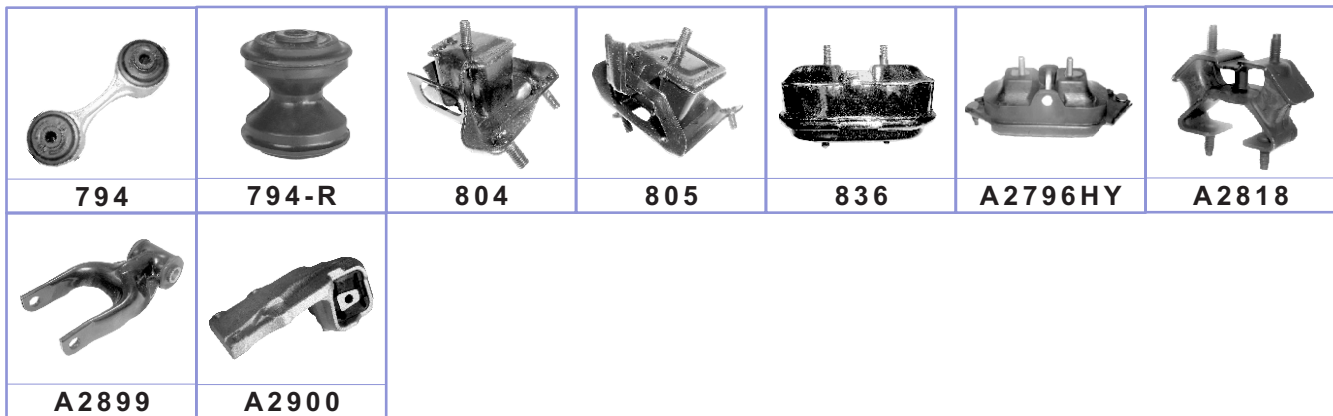

TERRAZA	MOTOR	MODELO	SOPORTE	ESPECIFICACIÓN	No. BUFALO	
"BUICK"	V6	3.9	05 - 07	MOTOR	FRONTAL / DER / IZQ / BRACKET RADIADOR	PRÓXIMAMENTE
				MOTOR	FRONTAL / DER	A2796HY
				MOTOR	TORSIÓN / FRONTAL / DER / IZQ	A2899
				TRANSMISIÓN		A2818

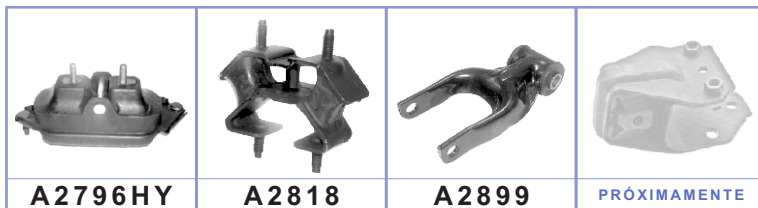

TRANS SPORT	MOTOR	MODELO	SOPORTE	ESPECIFICACIÓN	No. BUFALO	
	V6	3.1 3.8	90 - 95	MOTOR	FRONTAL	836
				MOTOR	TORSIÓN / FRONTAL / REPUESTO 794	794 - R
				MOTOR	TORSIÓN / FRONTAL	794
				TRANSMISIÓN	FRONTAL / IZQ	804
				TRANSMISIÓN	TRASERO / IZQ	805

TRANS SPORT	MOTOR	MODELO	SOPORTE	ESPECIFICACIÓN	No. BUFALO
V6 3.4	96		MOTOR	FRONTAL	<b>836</b>
			MOTOR	TORSIÓN / FRONTAL	<b>A2866</b>
			TRANSMISIÓN	FRONTAL / IZQ	<b>804</b>
			TRANSMISIÓN	TRASERO / IZQ	<b>805</b>
	97 - 04		MOTOR	FRONTAL / INFERIOR / DER / IZQ	<b>A2900</b>
			MOTOR	FRONTAL	<b>A2796HY</b>
			MOTOR	TORSIÓN / FRONTAL / DER / IZQ	<b>A2899</b>
			TRANSMISIÓN		<b>A2818</b>

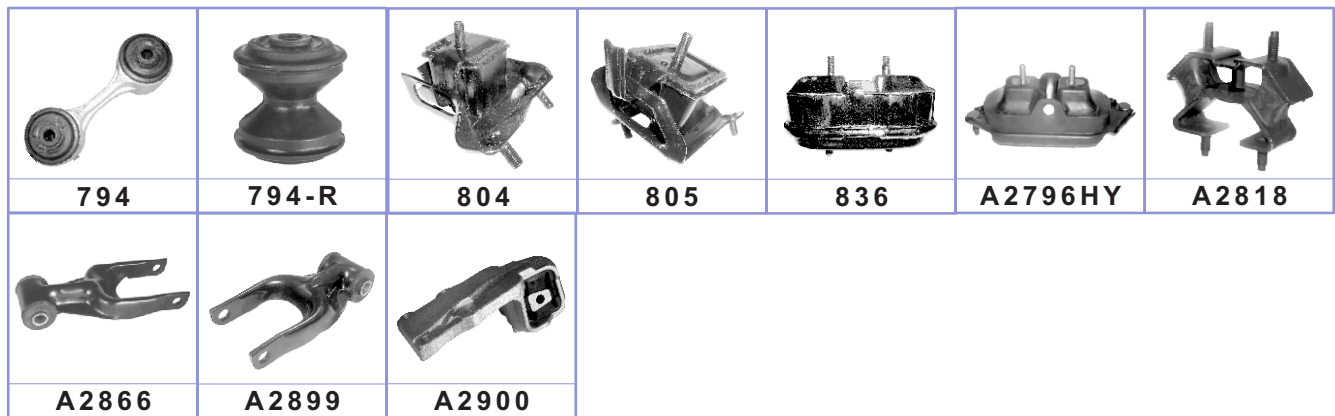

UPLANDER	MOTOR	MODELO	SOPORTE	ESPECIFICACIÓN	No. BUFALO
V6	3.5	05 - 07	MOTOR	FRONTAL / INF / DER / IZQ / BRACKET RADIADOR	<b>A2900</b>
			MOTOR	FRONTAL / DER	<b>A2796HY</b>
	3.9		MOTOR	TORSIÓN / FRONTAL / DER / IZQ	<b>A2899</b>
			TRANSMISIÓN		<b>A2818</b>

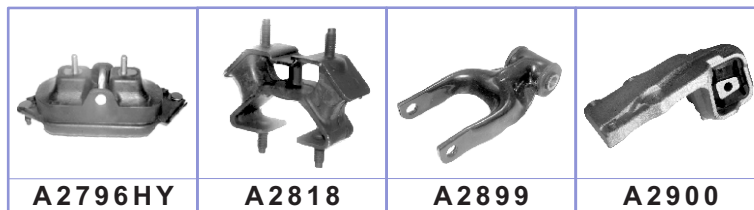

VENTURE	MOTOR	MODELO	SOPORTE	ESPECIFICACIÓN	No. BUFALO
V6 3.4	97 - 05		MOTOR	FRONTAL / INF / DER / IZQ / BRACKET RADIADOR	<b>A2900</b>
			MOTOR	FRONTAL / DER	<b>A2796HY</b>
			MOTOR	TORSIÓN / FRONTAL / DER / IZQ	<b>A2899</b>
			TRANSMISIÓN		<b>A2818</b>

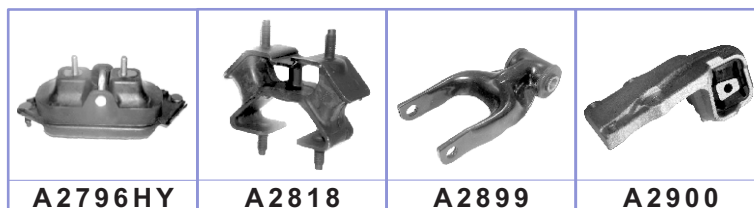



# CHRYSLER

**AUTOS**

300M	MOTOR	MODELO	SOPORTE	ESPECIFICACIÓN	No. BUFALO
V6 2.7	05 - 07	MOTOR	FRONTAL / DER / IZQ	PRÓXIMAMENTE	
		TRANSMISIÓN	PRÓXIMAMENTE		
V6 3.5	99 - 04	MOTOR	FRONTAL / DER / IZQ	<b>A2903HY</b>	
		MOTOR	FRONTAL / DER / IZQ	PRÓXIMAMENTE	
	08 - 10	TRANSMISIÓN	PRÓXIMAMENTE		
V6 5.7 6.1	05 - 10	MOTOR	FRONTAL / DER / IZQ	PRÓXIMAMENTE	
		TRANSMISIÓN	PRÓXIMAMENTE		

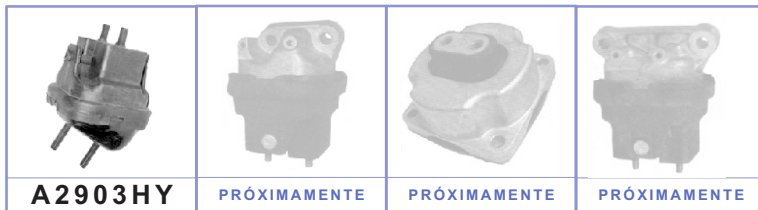

ATOS	MOTOR	MODELO	SOPORTE	ESPECIFICACIÓN	No. BUFALO		
L4 1.1	1.1	99 - 04	TRANSMISIÓN		<b>998</b>		
			MOTOR	FRONTAL	<b>1003</b>		
			MOTOR	TRASERO	<b>1004</b>		
		05 - 07	MOTOR	BUJE EJE / TRASERO	<b>1053</b>		
			TRANSMISIÓN		<b>1066</b>		
		05 - 08	MOTOR	FRONTAL / DER / IZQ	<b>1067</b>		
			TRANSMISIÓN		<b>A2185</b>		
		TODOS	MOTOR	PALANCA DE VELOCIDADES	<b>1028</b>		
			MOTOR	ABRAZADERA EXTERIOR	<b>A506-A</b>		
		05 - 10	MOTOR	FRONTAL / DER / IZQ	PRÓXIMAMENTE		
			MOTOR	TRASERO	<b>A2185</b>		
			TRANSMISIÓN		PRÓXIMAMENTE		
					MOTOR	PALANCA DE VELOCIDADES	<b>1028</b>



ATTITUDE	MOTOR	MODELO	SOPORTE	ESPECIFICACIÓN	No. BUFALO
<b>L4</b>	1.4 1.6	<b>06 - 10</b>	MOTOR	FRONTAL	PRÓXIMAMENTE
			MOTOR	FRONTAL / DER	PRÓXIMAMENTE
			MOTOR	TRASERO	PRÓXIMAMENTE
			TRANSMISIÓN	PALANCA DE VELOCIDADES	PRÓXIMAMENTE

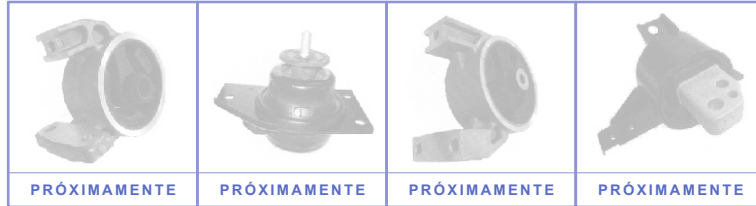

AVENGER	MOTOR	MODELO	SOPORTE	ESPECIFICACIÓN	No. BUFALO
<b>L4</b>	2.0 2.4	<b>07 - 11</b>	MOTOR	FRONTAL / REPUESTO	PRÓXIMAMENTE
			MOTOR	FRONTAL	PRÓXIMAMENTE
			MOTOR	FRONTAL / DER	<b>A5085476AC</b>
			MOTOR	TRASERO / REPUESTO	PRÓXIMAMENTE
			MOTOR	TRASERO	PRÓXIMAMENTE
			TRANSMISIÓN	STD / REPUESTO	PRÓXIMAMENTE
			TRANSMISIÓN	STD	PRÓXIMAMENTE
			TRANSMISIÓN	AUT / REPUESTO	PRÓXIMAMENTE
			TRANSMISIÓN	AUT	PRÓXIMAMENTE



BARRACUDA	MOTOR	MODELO	SOPORTE	ESPECIFICACIÓN	No. BUFALO
<b>L6</b>	2.8	<b>67 - 73</b>	MOTOR	FRONTAL / DER / IZQ	<b>565</b>
			MOTOR	FRONTAL / DER / IZQ	<b>579-A</b>
			MOTOR	IZQ	<b>585</b>

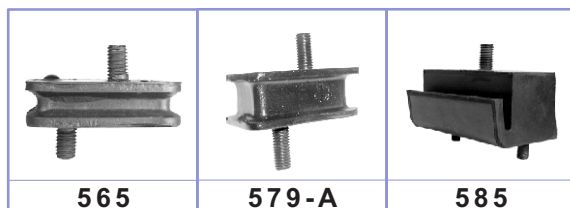



# CHRYSLER

**AUTOS**

BREEZER	MOTOR	MODELO	SOPORTE	ESPECIFICACIÓN	No. BUFALO
L4 2.0	96		MOTOR	FRONTAL	<b>884</b>
			MOTOR	FRONTAL	<b>A2979</b>
			TRANSMISIÓN	AUT / STD / REPUESTO A2848-A Y A2848-C	<b>893</b>
			TRANSMISIÓN	AUT	<b>A2848-C</b>
			TRANSMISIÓN	STD	<b>A2848-A</b>
	96 - 00		MOTOR	FRONTAL / DER	<b>950</b>
			MOTOR	TRASERO / REPUESTO A2945	<b>918</b>
			MOTOR	TRASERO	<b>A2945</b>
	97 - 00		MOTOR	FRONTAL / REPUESTO 1040	<b>917</b>
			MOTOR	FRONTAL	<b>A2958</b>
			TRANSMISIÓN		<b>967</b>

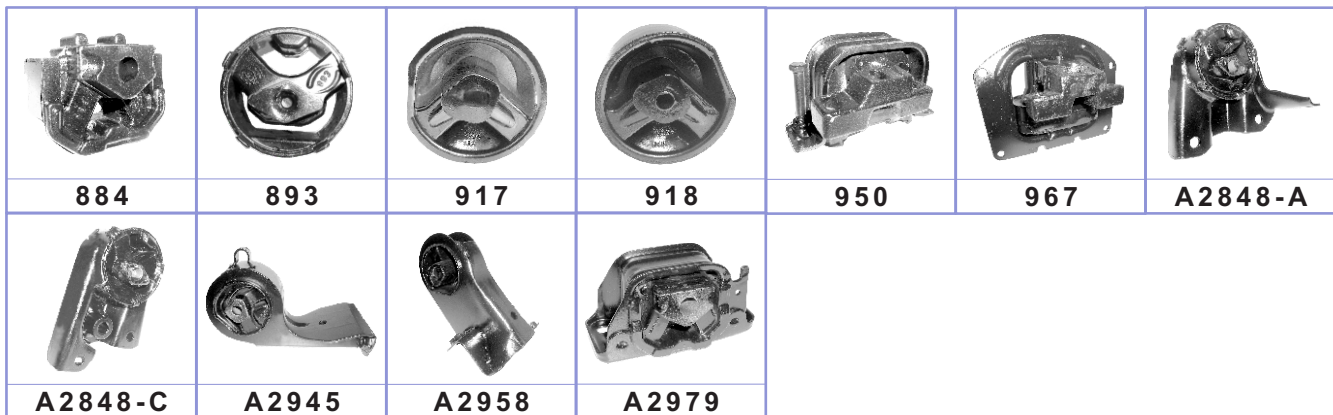

CALIBER	MOTOR	MODELO	SOPORTE	ESPECIFICACIÓN	No. BUFALO
L4 2.4		07 - 11	MOTOR	FRONTAL	<b>A103-C</b>
			MOTOR	FRONTAL / DER	<b>PRÓXIMAMENTE</b>
			MOTOR	TRASERO / STD / REPUESTO	<b>A104</b>
			MOTOR	TRASERO / STD	<b>PRÓXIMAMENTE</b>
			MOTOR	TRASERO / AUT / REPUESTO	<b>A10</b>
			MOTOR	TRASERO / AUT	<b>PRÓXIMAMENTE</b>
			TRANSMISIÓN		<b>PRÓXIMAMENTE</b>

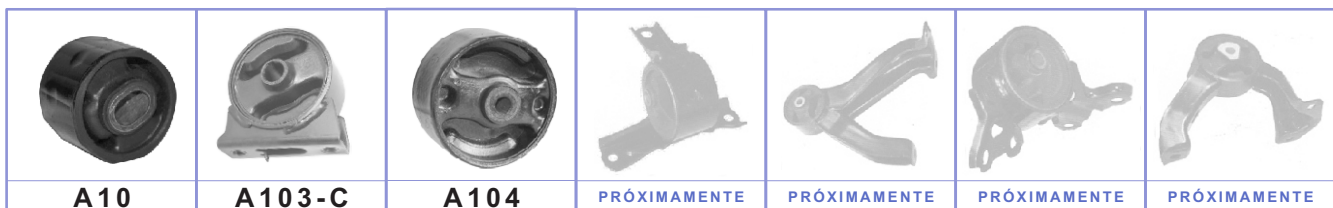

CHARGER	MOTOR	MODELO	SOPORTE	ESPECIFICACIÓN	No. BUFALO
V6 2.7	06 - 07		MOTOR	FRONTAL / DER / IZQ	<b>PRÓXIMAMENTE</b>
			TRANSMISIÓN		<b>PRÓXIMAMENTE</b>
V6 3.5	06 - 10		MOTOR	FRONTAL / DER / IZQ	<b>PRÓXIMAMENTE</b>
			TRANSMISIÓN		<b>PRÓXIMAMENTE</b>

CONTINÚA...

<b>CHARGER</b>	V6	5.7 6.1	06 - 10	MOTOR	FRONTAL / DER / IZQ	PRÓXIMAMENTE
				TRANSMISIÓN		PRÓXIMAMENTE



<b>CIRRUS (MEX)</b>	MOTOR	MODELO	SOPORTE	ESPECIFICACIÓN	No. <b>BUFALO</b>
L4	2.4	01 - 06	MOTOR	FRONTAL / DER / AUT / TURBO	<b>1033</b>
			MOTOR	FRONTAL / DER	<b>950</b>
			MOTOR	TRASERO / AUT / TURBO	<b>1034</b>
			TRANSMISIÓN	AUT / STD	<b>967</b>
		07 - 11	MOTOR	FRONTAL / REPUESTO	PRÓXIMAMENTE
			MOTOR	FRONTAL	PRÓXIMAMENTE
			MOTOR	TRASERO / DER	<b>A5085476AC</b>
			MOTOR	TRASERO / REPUESTO	PRÓXIMAMENTE
			MOTOR	TRASERO	PRÓXIMAMENTE
			TRANSMISIÓN	STD / REPUESTO	PRÓXIMAMENTE
			TRANSMISIÓN	STD	PRÓXIMAMENTE
			TRANSMISIÓN	AUT / REPUESTO	PRÓXIMAMENTE
			TRANSMISIÓN	AUT	PRÓXIMAMENTE
			V6	2.7	97 - 00
MOTOR	FRONTAL	<b>A2958</b>			
MOTOR	FRONTAL / DER	<b>950</b>			
MOTOR	TRASERO / REPUESTO A2945	<b>918</b>			
MOTOR	TRASERO	<b>A2945</b>			
TRANSMISIÓN		<b>967</b>			

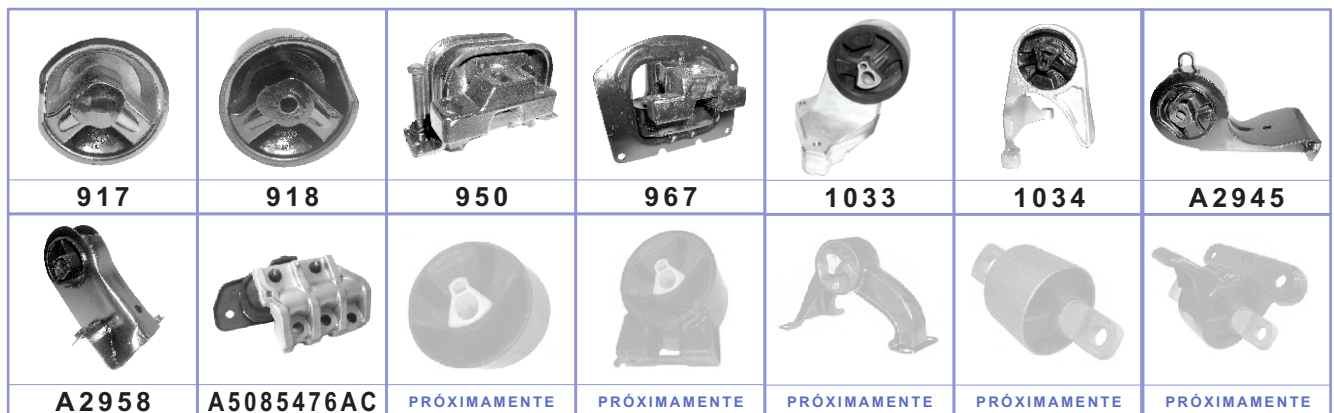



# CHRYSLER

**AUTOS**

CIRRUS (USA)		MOTOR	MODELO	SOPORTE	ESPECIFICACIÓN	No. BUFALO
L4	2.0	00	MOTOR	FRONTAL / REPUESTO A2958	918	
			MOTOR	FRONTAL	A2958	
			MOTOR	FRONTAL / DER	950	
			TRANSMISIÓN		967	
L4	2.4	95 - 97	MOTOR	BARRA FRONTAL / BARRA TRASERO	917	
			MOTOR	BARRA FRONTAL / BARRA TRASERO	918	
		95 - 00	MOTOR	FRONTAL / DER	950	
			TRANSMISIÓN		967	
V6	2.5	98 - 00	MOTOR	FRONTAL / REPUESTO A2958	917	
			MOTOR	FRONTAL	A2958	
			MOTOR	TRASERO / REPUESTO A2945	918	
			MOTOR	TRASERO	A2945	

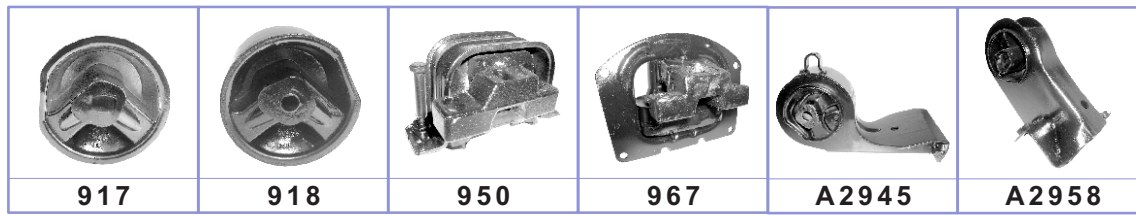

CONCORD		MOTOR	MODELO	SOPORTE	ESPECIFICACIÓN	No. BUFALO
V6	2.7	98 - 04	MOTOR	FRONTAL / IZQ	A2903HY	
			MOTOR	FRONTAL / DER	PRÓXIMAMENTE	
			TRANSMISIÓN		A2908	
V6	3.2	98 - 01	MOTOR	FRONTAL / DER / IZQ	A2903	
			TRANSMISIÓN		A2908	
V6	3.3	93 - 99	MOTOR	FRONTAL / DER / IZQ	A2795	
			TRANSMISIÓN		959	
V6	3.5	93 - 99	MOTOR	FRONTAL / DER / IZQ	A2795	
			TRANSMISIÓN		959	
		00 - 05	MOTOR	FRONTAL / DER / IZQ	A2903	
			TRANSMISIÓN		A2908	

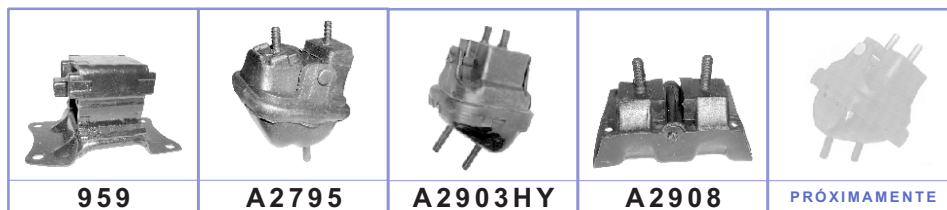



CORONET	MOTOR	MODELO	SOPORTE	ESPECIFICACIÓN	No. BUFALO
	V8 5.2, 5.9	73 - 82	TRANSMISIÓN	FRONTAL / DER / IZQ	743



743

DART	MOTOR	MODELO	SOPORTE	ESPECIFICACIÓN	No. BUFALO
L6		63 - 73	MOTOR	FRONTAL / IZQ	585
		67 - 73	MOTOR	FRONTAL / DER / IZQ	565
			MOTOR	FRONTAL / DER / IZQ	579-A
		74 - 82	MOTOR	IZQ	724
			MOTOR	IZQ	725



565

579-A

585

724

725

DART K	MOTOR	MODELO	SOPORTE	ESPECIFICACIÓN	No. BUFALO
L4		82 - 89	MOTOR	FRONTAL / DER	788
			MOTOR	FRONTAL	894
		82 - 90	MOTOR	FRONTAL	793
			TRANSMISIÓN	TRASERO	791
		83 - 87	TRANSMISIÓN	IZQ	806
			TRANSMISIÓN	CON BUJE	A806-C

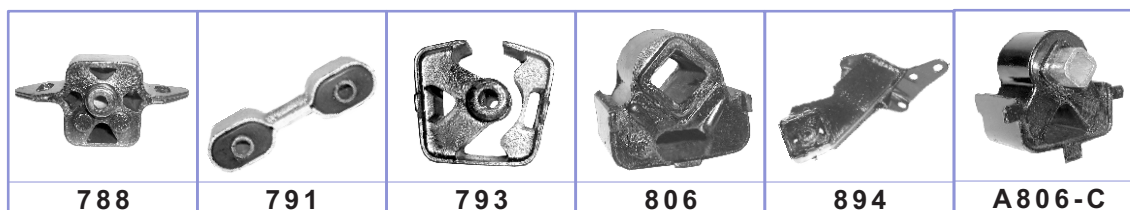

788

791

793

806

894

A806-C

INTREPID	MOTOR	MODELO	SOPORTE	ESPECIFICACIÓN	No. BUFALO
V6	2.7	98 - 04	MOTOR	FRONTAL / IZQ	PRÓXIMAMENTE
			MOTOR	FRONTAL / DER	A2903HY
			TRANSMISIÓN		A2908
V6	3.2	98 - 01	MOTOR	FRONTAL / DER / IZQ	A2903HY
			TRANSMISIÓN		A2908

CONTINÚA...



# CHRYSLER

**AUTOS**

INTREPID		MOTOR	ESPECIFICACIÓN	No. BUFALO	
V6	3.3	93 - 99	MOTOR	FRONTAL / DER / IZQ	<b>A2795</b>
			TRANSMISIÓN		<b>959</b>
V6	3.5	93 - 99	MOTOR	FRONTAL / DER / IZQ	<b>A2795</b>
			TRANSMISIÓN		<b>959</b>
		00 - 05	MOTOR	FRONTAL / DER / IZQ	<b>A2903HY</b>
			TRANSMISIÓN		<b>A2908</b>

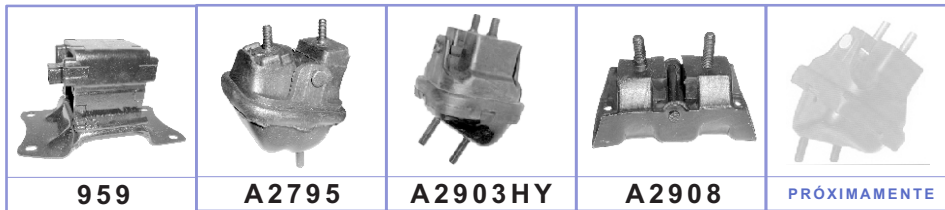

LEBARON	MOTOR	MODELO	SOPORTE	ESPECIFICACIÓN	No. BUFALO
L4	2.2	82 - 90	MOTOR	FRONTAL / INF / <i>REPUESTO 894</i>	<b>793</b>
			MOTOR	FRONTAL / INF	<b>894</b>
			MOTOR	FRONTAL / DER / <i>TRANSMISIONES MOD. 82 - 83</i>	<b>788</b>
			MOTOR	TORSIÓN / TRASERA	<b>971</b>
			TRANSMISIÓN	IZQ	<b>851</b>
			TRANSMISIÓN	IZQ	<b>806</b>
			TRANSMISIÓN	<i>REPUESTO CON BUJE</i>	<b>A806-C</b>
			TRANSMISIÓN	<i>16 VÁLVULAS</i>	<b>A806-C</b>
L4	2.5	86 - 89	MOTOR	FRONTAL / INF / <i>REPUESTO 894</i>	<b>793</b>
			MOTOR	FRONTAL / INF	<b>894</b>
			MOTOR	FRONTAL / DER	<b>788</b>
			TRANSMISIÓN		<b>806</b>
			TRANSMISIÓN	<i>16 VÁLVULAS</i>	<b>A806-C</b>
		86 - 89	MOTOR	FRONTAL / DER / <i>AUTOS GTC</i>	<b>A2711</b>
			MOTOR	FRONTAL / DER	<b>852</b>
		86 - 89	MOTOR	FRONTAL / INF / <i>REPUESTO</i>	<b>850</b>
			MOTOR	FRONTAL / INF	<b>PRÓXIMAMENTE</b>
			TRANSMISIÓN	<i>REPUESTO</i>	<b>A2618</b>
TRANSMISIÓN		<b>PRÓXIMAMENTE</b>			
V6	3.0	86 - 89	MOTOR	FRONTAL / INF / <i>REPUESTO</i>	<b>850</b>
			MOTOR	FRONTAL / INF	<b>PRÓXIMAMENTE</b>
			MOTOR	FRONTAL / DER / <i>AUTOS GTC</i>	<b>A2711</b>
	3.7		MOTOR	FRONTAL / DER	<b>852</b>
			TRANSMISIÓN	REPUESTO	<b>A2618</b>
	TRANSMISIÓN			<b>PRÓXIMAMENTE</b>	
	TRANSMISIÓN		REPUESTO	<b>851</b>	

LEBARÓN K	MOTOR	MODELO	SOPORTE	ESPECIFICACIÓN	No. BUFALO
L4	2.2	82 - 89	MOTOR	FRONTAL / INF	<b>894</b>

CONTINÚA...

<b>LEBARÓN</b> <b>LEBARÓN K</b>						
	<b>788</b>	<b>793</b>	<b>806</b>	<b>850</b>	<b>851</b>	<b>852</b>
<b>894</b>	<b>971</b>	<b>A806-C</b>	<b>A2618</b>	<b>A2711</b>	<b>PRÓXIMAMENTE</b>	<b>PRÓXIMAMENTE</b>
	<b>PRÓXIMAMENTE</b>					

LHS	MOTOR	MODELO	SOPORTE	ESPECIFICACIÓN	No. <b>BUFALO</b>
V6 3.5		94 - 97	MOTOR	FRONTAL / DER / IZQ	<b>A2795</b>
			TRANSMISIÓN		<b>959</b>
		94 - 97	TRANSMISIÓN		<b>A2908</b>

<b>959</b>	<b>A2795</b>	<b>A2908</b>

MAGNUM	MOTOR	MODELO	SOPORTE	ESPECIFICACIÓN	No. <b>BUFALO</b>
V6 2.7		06 - 07	MOTOR	FRONTAL / DER / IZQ	<b>PRÓXIMAMENTE</b>
			TRANSMISIÓN		<b>PRÓXIMAMENTE</b>
V6 3.5		06 - 10	MOTOR	FRONTAL / DER / IZQ	<b>PRÓXIMAMENTE</b>
			TRANSMISIÓN		<b>PRÓXIMAMENTE</b>
V8 5.7 6.1		06 - 10	MOTOR	FRONTAL / DER / IZQ	<b>PRÓXIMAMENTE</b>
			TRANSMISIÓN		<b>PRÓXIMAMENTE</b>

<b>PRÓXIMAMENTE</b>	<b>PRÓXIMAMENTE</b>	<b>PRÓXIMAMENTE</b>



# CHRYSLER

**AUTOS**

NEÓN	MOTOR	MODELO	SOPORTE	ESPECIFICACIÓN	No. BUFALO
L4	2.0	95 - 99	MOTOR	FRONTAL / INF / REPUESTO A2868	929
			MOTOR	FRONTAL / INF	A2867
			MOTOR	FRONTAL / DER / REPUESTO A2979	884
			MOTOR	FRONTAL / DER	A2979
			TRANSMISIÓN	AUT / STD / REPUESTO A2848-C Y A2848-A	893
			TRANSMISIÓN	AUT	A2848-C
			TRANSMISIÓN	STD	A2848-A

L4	2.0 2.4	00 - 05	MOTOR	FRONTAL / INF / DER / 72 MM. REPUESTO A2949	987/986-A
			MOTOR	FRONTAL / INF / DER / 70 MM. REPUESTO A2949	987/986-A
			MOTOR	FRONTAL / INF / DER	A2949
			MOTOR	FRONTAL / CENTRAL / REPUESTO A2947	984
			MOTOR	FRONTAL / CENTRAL	A2947
			MOTOR	FRONTAL / SUPERIOR / DER / REPUESTO A2948	987/986
			MOTOR	FRONTAL / SUPERIOR / DER	A2948
			TRANSMISIÓN	AUT / STD / REPUESTO A2975	A2975-R
			TRANSMISIÓN	AUT	A2975
			TRANSMISIÓN	STD	1081
			TRANSMISIÓN	FRONTAL / AUT / STD	1051
		00 - 07	TRANSMISIÓN		5260
			TRANSMISIÓN	AUT	A5261-R



NEW YORKER	MOTOR	MODELO	SOPORTE	ESPECIFICACIÓN	No. BUFALO
L4	2.0	83 - 90	MOTOR	FRONTAL / INF / REPUESTO 894	793
			MOTOR	FRONTAL / INF	894
			MOTOR	FRONTAL / DER	788
			MOTOR	TRASERO	791

CONTINÚA...

NEW YORKER		MOTOR	MODELO	SOPORTE	ESPECIFICACIÓN	No. BUFALO
L4	2.2	83 - 90	TRANSMISIÓN			<b>806</b>
			TRANSMISIÓN		REPUESTO CON BUJE	<b>A806-C</b>
			TRANSMISIÓN		16 VÁLVULAS	PRÓXIMAMENTE
			ALTERNADOR		BASE LATERAL	<b>953</b>
L4	2.5	86 - 90	MOTOR		FRONTAL / INF / REPUESTO 894	<b>793</b>
			MOTOR		FRONTAL / INF	<b>894</b>
			MOTOR		FRONTAL / DER	<b>788</b>
			MOTOR		TORSIÓN / TRASERO	<b>791</b>
			TRANSMISIÓN			<b>806</b>
			TRANSMISIÓN		16 VÁLVULAS	<b>A806C</b>
V6	3.0	88	MOTOR		FRONTAL / DER	<b>788</b>
			MOTOR		FRONTAL / INF / REPUESTO	<b>850</b>
		88 - 90	MOTOR		FRONTAL / INF	PRÓXIMAMENTE
			MOTOR			<b>806</b>
			TRANSMISIÓN		16 VÁLVULAS	<b>A806C</b>
			TRANSMISIÓN		FRONTAL / DER	<b>A2711</b>
V6	3.3	90 - 95	MOTOR		FRONTAL / INF / REPUESTO	<b>850</b>
			MOTOR		FRONTAL / INF	PRÓXIMAMENTE
			MOTOR		FRONTAL / DER	<b>A2711</b>
			TRANSMISIÓN			<b>806</b>
			TRANSMISIÓN		16 VÁLVULAS	<b>A806C</b>
V6	3.5	94 - 99	MOTOR		FRONTAL / INF / REPUESTO	<b>A2795</b>
			TRANSMISIÓN		FRONTAL / INF	<b>959</b>
			ALTERNADOR		BASE / LATERAL	<b>953</b>

<b>788</b>	<b>791</b>	<b>793</b>	<b>806</b>	<b>850</b>	<b>894</b>	<b>953</b>
<b>959</b>	<b>A806-C</b>	<b>A2711</b>	<b>A2795</b>	PRÓXIMAMENTE	PRÓXIMAMENTE	



# CHRYSLER

**AUTOS**

P.T. CRUISER	MOTOR	MODELO	SOPORTE	ESPECIFICACIÓN	No. BUFALO
L4 2.4		95 - 00	MOTOR	FRONTAL	<b>A2867</b>
		00 - 02	MOTOR	FRONTAL / DER	<b>984</b>
		00 - 07	TRANSMISIÓN	FRONTAL / AUT / STD	<b>1051</b>
			TRANSMISIÓN	FRONTAL / AUT	<b>1081</b>
			TRANSMISIÓN	AUT / STD / REPUESTO A2975	<b>A2975-R</b>
			TRANSMISIÓN	AUT / STD	<b>A2975</b>
			TRANSMISIÓN	AUT / REPUESTO A5260	<b>A5261-R</b>
			TRANSMISIÓN	AUT	<b>A5260</b>
			01 - 10	MOTOR	FRONTAL / 72 MM. / REPUESTO A2949
		MOTOR		FRONTAL / 70 MM. / REPUESTO A2949	<b>987/986-A</b>
		MOTOR		FRONTAL	<b>A2949</b>
		MOTOR		FRONTAL / DER / SUPERIOR / REPUESTO A 2948	<b>987/986</b>
		MOTOR		FRONTAL / DER / SUPERIOR	<b>A2948</b>
		MOTOR		TRASERO / INF / REPUESTO	<b>987/986-A</b>
		MOTOR		TRASERO / INF	<b>PRÓXIMAMENTE</b>
		TRANSMISIÓN		REPUESTO A 2947	<b>984</b>
		TRANSMISIÓN			<b>A2947</b>
		TRANSMISIÓN			<b>PRÓXIMAMENTE</b>



# CALIDAD Y GARANTÍA DE EXPORTACIÓN

PHANTOM	MOTOR	MODELO	SOPORTE	ESPECIFICACIÓN	No. BUFALO
L4	2.2	87 - 89	MOTOR	TORSIÓN / TRASERO	791
			TRANSMISIÓN		806
			TRANSMISIÓN	REPUESTO CON BUJE	A806-C
			TRANSMISIÓN	16 VÁLVULAS	806
	2.5	87 - 90	MOTOR	FRONTAL / DER	788
			MOTOR	FRONTAL / INF / REPUESTO 894	793
	90 - 95		MOTOR	FRONTAL / INF	894
			TRANSMISIÓN	REPUESTO	851
			TRANSMISIÓN		PRÓXIMAMENTE
				TRANSMISIÓN	

V6	3.0	92 - 94	MOTOR	FRONTAL / INF	850
			MOTOR	FRONTAL / INF	PRÓXIMAMENTE
			MOTOR	FRONTAL / DER	A2711
			TRANSMISIÓN	REPUESTO	851
			TRANSMISIÓN		PRÓXIMAMENTE
			TRANSMISIÓN		A2618



SEBRING	MOTOR	MODELO	SOPORTE	ESPECIFICACIÓN	No. BUFALO
L4	2.4	96 - 99	MOTOR	FRONTAL	917
			MOTOR	FRONTAL / INF	A2958
	96 - 05		MOTOR	FRONTAL / DER	950
			TRANSMISIÓN	REPUESTO	918
	01 - 05		TRANSMISIÓN		A2945
			TRANSMISIÓN		967
	07 - 11		MOTOR	FRONTAL / REPUESTO	PRÓXIMAMENTE
			MOTOR	FRONTAL	PRÓXIMAMENTE
			MOTOR	FRONTAL / DER	A5085476AC
			MOTOR	TRASERO / REPUESTO	PRÓXIMAMENTE
			MOTOR	TRASERO	PRÓXIMAMENTE
			TRANSMISIÓN	STD / REPUESTO	PRÓXIMAMENTE
			TRANSMISIÓN	STD	PRÓXIMAMENTE
			TRANSMISIÓN	AUT / REPUESTO	PRÓXIMAMENTE
		TRANSMISIÓN	AUT	PRÓXIMAMENTE	



# CHRYSLER

**AUTOS**

SEBRING LX/JR	MOTOR	MODELO	SOPORTE	ESPECIFICACIÓN	No. BUFALO
	L4 2.4	01 - 06	MOTOR	FRONTAL	<b>1033</b>
			MOTOR	FRONTAL / DER	<b>950</b>
	V6 2.7		MOTOR	TRASERO	<b>1034</b>
			TRANSMISIÓN		<b>967</b>

V6 3.0	01 - 05	MOTOR	FRONTAL / DER	PRÓXIMAMENTE
		MOTOR	TRASERO	PRÓXIMAMENTE
		TRANSMISIÓN	AUT	PRÓXIMAMENTE



SHADOW	MOTOR	MODELO	SOPORTE	ESPECIFICACIÓN	No. BUFALO	
	L4	87 - 89	MOTOR	TORSIÓN / TRASERO	<b>791</b>	
			TRANSMISIÓN		<b>806</b>	
			TRANSMISIÓN	REPUESTO CON BUJE	<b>A806-C</b>	
			TRANSMISIÓN	16 VÁLVULAS	PRÓXIMAMENTE	
		2.2	87 - 90	MOTOR	FRONTAL / DER	<b>788</b>
				MOTOR	FRONTAL / INF / REPUESTO 894	<b>793</b>
		2.5	87 - 95	MOTOR	FRONTAL / INF	<b>894</b>
				ALTERNADOR		<b>953</b>
				TRANSMISIÓN	REPUESTO	<b>851</b>
		90 - 95	91 - 95	TRANSMISIÓN		PRÓXIMAMENTE
				MOTOR	FRONTAL / INF / REPUESTO	<b>850</b>
				MOTOR	FRONTAL / INF	PRÓXIMAMENTE
					MOTOR	FRONTAL / DER

CONTINÚA...



SHADOW		MOTOR	MODELO	SOPORTE	ESPECIFICACIÓN	No. BUFALO
V6	3.0		92 - 94	MOTOR	FRONTAL / INF / REPUESTO	<b>850</b>
				MOTOR	FRONTAL / INF	PRÓXIMAMENTE
				MOTOR	FRONTAL / DER	<b>A2711</b>
				TRANSMISIÓN	REPUESTO	<b>851</b>
				TRANSMISIÓN		PRÓXIMAMENTE

<b>788</b>	<b>791</b>	<b>793</b>	<b>806</b>	<b>850</b>	<b>851</b>	<b>852</b>
<b>894</b>	<b>953</b>	<b>A806-C</b>	<b>A2711</b>	PRÓXIMAMENTE	PRÓXIMAMENTE	PRÓXIMAMENTE

SPIRIT		MOTOR	MODELO	SOPORTE	ESPECIFICACIÓN	No. BUFALO
L4	2.2		91 - 93	MOTOR	FRONTAL / INF / REPUESTO	<b>850</b>
				MOTOR	FRONTAL / INF	PRÓXIMAMENTE
				MOTOR	FRONTAL / DER	<b>852</b>
				TRANSMISIÓN	REPUESTO	<b>851</b>
				TRANSMISIÓN		PRÓXIMAMENTE
				ALTERNADOR	BASE LATERAL	<b>953</b>
				TRANSMISIÓN	REPUESTO	<b>A2618</b>





L4	2.5	89	MOTOR	FRONTAL / DER	<b>788</b>	
			TRANSMISIÓN		<b>806</b>	
			TRANSMISIÓN	REPUESTO CON BUJE	<b>A806-C</b>	
			TRANSMISIÓN	16 VÁLVULAS	PRÓXIMAMENTE	
	89 - 95	MOTOR	FRONTAL / INF / REPUESTO	<b>850</b>		
		MOTOR	FRONTAL / INF	PRÓXIMAMENTE		
	90 - 93	MOTOR	FRONTAL / DER / MOT. 3.0	<b>852</b>		
		MOTOR	FRONTAL / DER / MOT. 2.5	<b>852</b>		
	V6	3.0	90 - 95	TRANSMISIÓN	REPUESTO	<b>851</b>
				TRANSMISIÓN		PRÓXIMAMENTE
				ALTERNADOR	MOT. 2.5 LTS.	<b>953</b>
				TRANSMISIÓN	REPUESTO	<b>A2618</b>
	94 - 95	MOTOR	FRONTAL / DER / MOT. 3.0	<b>A2711</b>		

<b>788</b>	<b>806</b>	<b>850</b>	<b>851</b>	<b>852</b>	<b>953</b>	<b>A806-C</b>









# CHRYSLER

**AUTOS**

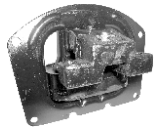
<b>SPIRIT</b>					
	<b>A2618</b>	<b>A2711</b>	PRÓXIMAMENTE	PRÓXIMAMENTE	PRÓXIMAMENTE

STRATUS MEX	MOTOR	MODELO	SOPORTE	ESPECIFICACIÓN	No. BUFALO	
L4	2.0	95 - 97	MOTOR	BARRA FRONTAL / BARRA LATERAL	917	
			TRANSMISIÓN	BARRA FRONTAL / BARRA LATERAL	918	
		95 - 00	MOTOR	FRONTAL / DER	950	
			TRANSMISIÓN		967	
		2.4	98 - 00	MOTOR	FRONTAL / REPUESTO A2858	917
				MOTOR	FRONTAL	A2858
	TRANSMISIÓN			REPUESTO A2945	918	
	L4	2.4	01 - 06	MOTOR	FRONTAL / AUT / STD	1033
				MOTOR	FRONTAL / DER	950
				MOTOR	TRASERO	1034
TRANSMISIÓN					967	

						
<b>917</b>	<b>918</b>	<b>950</b>	<b>967</b>	<b>1033</b>	<b>1034</b>	<b>A2945</b>
						
<b>A2958</b>						

STRATUS USA	MOTOR	MODELO	SOPORTE	ESPECIFICACIÓN	No. BUFALO
L4	2.0	95	MOTOR	FRONTAL / DER / REPUESTO	884
			MOTOR	FRONTAL / DER	A2979
		95 - 96	MOTOR	FRONTAL / INF / REPUESTO A2867	929
			TRANSMISIÓN	AUT	A2848-A
			MOTOR	FRONTAL / INF	A2867
			TRANSMISIÓN	REPUESTO A2848-A	893
		95 - 97	MOTOR	TRASERO / REPUESTO A2945	918
			MOTOR	TRASERO	A2945
		96 - 00	MOTOR	FRONTAL / DER	950
			MOTOR	FRONTAL / REPUESTO A2958	917
		97 - 00	MOTOR	FRONTAL	A2958
			TRANSMISIÓN	STD	A2848-A
			TRANSMISIÓN	AUT / STD / 5 VEL	967

CONTINÚA...

<b>STRATUS USA</b>						
	<b>884</b>	<b>893</b>	<b>917</b>	<b>918</b>	<b>929</b>	<b>950</b>
<b>967</b>	<b>A2848-A</b>	<b>A2867</b>	<b>A2945</b>	<b>A2958</b>	<b>A2979</b>	

<b>STRATUS USA (MITSUBISHI)</b>	MOTOR	MODELO	SOPORTE	ESPECIFICACIÓN	No. <b>BUFALO</b>
	L4 2.4	00 - 05	MOTOR	TRASERO / AUT	<b>A8798</b>
			MOTOR	FRONTAL	<b>A9160</b>
			MOTOR	FRONTAL / IZQ / AUT	<b>A9184</b>
		01 - 06	TRANSMISIÓN	AUT	<b>PRÓXIMAMENTE</b>

<b>A8798</b>	<b>A9160</b>	<b>A9184</b>	<b>PRÓXIMAMENTE</b>

<b>STRATUS (JA) (USA)</b>	MOTOR	MODELO	SOPORTE	ESPECIFICACIÓN	No. <b>BUFALO</b>
	L4 2.4	01 - 07	MOTOR	FRONTAL	<b>1033</b>
			MOTOR	FRONTAL / DER	<b>950</b>
			MOTOR	TRASERO	<b>1034</b>
			TRANSMISIÓN		<b>967</b>

V6 2.5	95 - 97	MOTOR	BARRA FRONTAL / TRASERA	<b>917</b>
		MOTOR	BARRA FRONTAL / TRASERA	<b>918</b>
	95 - 00	MOTOR	FRONTAL / DER	<b>950</b>
		TRANSMISIÓN		<b>967</b>
	98 - 00	MOTOR	FRONTAL / REPUESTO A2958	<b>917</b>
		MOTOR	FRONTAL	<b>A2958</b>
		MOTOR	TRASERO / REPUESTO A2945	<b>918</b>
		MOTOR	TRASERO	<b>A2945</b>







V6 2.7	01 - 07	MOTOR	FRONTAL	<b>1033</b>
		MOTOR	FRONTAL / DER	<b>950</b>
		MOTOR	TRASERO	<b>1034</b>
		TRANSMISIÓN		<b>967</b>

CONTINÚA...



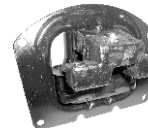

# CHRYSLER





**AUTOS**

<b>STRATUS</b> (JA) (USA)						
	<b>917</b>	<b>918</b>	<b>950</b>	<b>967</b>	<b>1033</b>	<b>1034</b>
						
<b>A2945</b>	<b>A2958</b>					

<b>SUPER BEE</b>	MOTOR	MODELO	SOPORTE	ESPECIFICACIÓN	No. BUFALO
	<b>V8</b>	<b>74 - 82</b>	MOTOR	FRONTAL / DER / 318 / 360	<b>726</b>
			MOTOR	FRONTAL / IZQ	<b>726-A</b>

	
<b>726</b>	<b>726-A</b>

<b>VALIANT</b>	MOTOR	MODELO	SOPORTE	ESPECIFICACIÓN	No. BUFALO
	<b>L6</b>	<b>67 - 73</b>	MOTOR	FRONTAL / DER / IZQ	<b>565</b>
			MOTOR	FRONTAL / DER / IZQ	<b>579-A</b>
			MOTOR	IZQ	<b>585</b>
	<b>V8</b>	<b>74 - 82</b>	MOTOR	DER / 225	<b>724</b>
			MOTOR	IZQ / 225	<b>725</b>
			TRANSMISIÓN	AUT / STD	<b>743</b>

					
<b>565</b>	<b>579-A</b>	<b>585</b>	<b>724</b>	<b>725</b>	<b>743</b>

# CALIDAD Y GARANTÍA

# CHRYSLER

**AUTOS**



VERNA		MOTOR	MODELO	SOPORTE	ESPECIFICACIÓN	No. BUFALO
L6	1.5	04 - 05	MOTOR	FRONTAL / DER / IZQ	<b>A2183-A</b>	
			MOTOR	FRONTAL / DER / IZQ	PRÓXIMAMENTE	
			MOTOR	IZQ	PRÓXIMAMENTE	
			TRANSMISIÓN		PRÓXIMAMENTE	
L6	1.6	04 - 05	MOTOR	FRONTAL / STD	<b>A2183-A</b>	
			MOTOR	FRONTAL / DER / STD	PRÓXIMAMENTE	
			MOTOR	TRASERO	PRÓXIMAMENTE	



# DODGE

**AUTOS**

SUMMIT		MOTOR	MODELO	SOPORTE	ESPECIFICACIÓN	No. BUFALO
L4	1.5	93	MOTOR	FRONTAL / AUT	PRÓXIMAMENTE	
			MOTOR	FRONTAL / AUT	PRÓXIMAMENTE	
		93 - 94	MOTOR	TRASERO	PRÓXIMAMENTE	
		93 - 96	MOTOR	STD / 5 VEL	PRÓXIMAMENTE	
			MOTOR	FRONTAL / IZQ	PRÓXIMAMENTE	
L4	1.8	92 - 93	MOTOR	FRONTAL / AUT / 4 VEL	PRÓXIMAMENTE	
			MOTOR	FRONTAL / IZQ / AUT	PRÓXIMAMENTE	
		92 - 96	MOTOR	TRASERO / AUT / WAGON	PRÓXIMAMENTE	
			MOTOR	TRASERO / STD / WAGON	PRÓXIMAMENTE	
L4	2.4	95 - 96	MOTOR	TRASERO / AUT / WAGON	PRÓXIMAMENTE	
			MOTOR	TRASERO / STD / WAGON	PRÓXIMAMENTE	

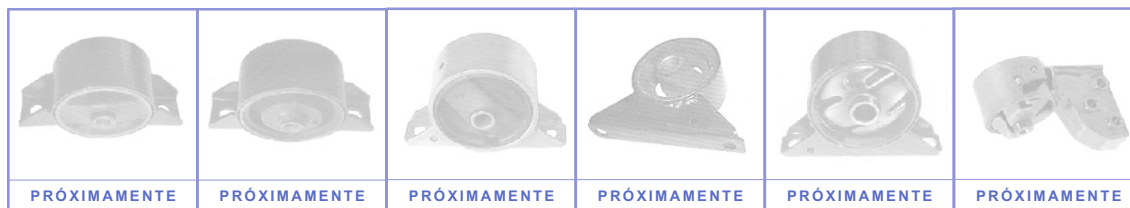



# D O D G E

---

**AUTOS**

TALON	MOTOR	MODELO	SOPORTE	ESPECIFICACIÓN	No. BUFALO
L4	1.8	93 - 94	MOTOR	FRONTAL	PRÓXIMAMENTE
			MOTOR	TRASERO / AUT	PRÓXIMAMENTE
L4	1.8	90 - 94	MOTOR	FRONTAL	PRÓXIMAMENTE
			TRANSMISIÓN	DEL / AUT	PRÓXIMAMENTE
		95 - 98	MOTOR	FRONTAL	PRÓXIMAMENTE
			MOTOR	FRONTAL / IZQ	<b>A9187</b>
			MOTOR	TRASERO	PRÓXIMAMENTE
			TRANSMISIÓN	STD / 5 VEL	<b>A8793</b>



VISION	MOTOR	MODELO	SOPORTE	ESPECIFICACIÓN	No. BUFALO
V6	3.3 3.5	85 - 97	MOTOR	FRONTAL / DER / IZQ	<b>A2795</b>
			TRANSMISIÓN		<b>959</b>
			MOTOR	TRASERO / DER / IZQ / BARRA	<b>A2797</b>

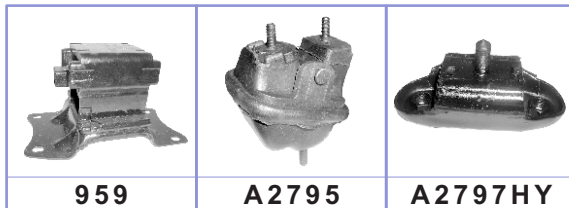

# CALIDAD Y GARANTÍA DE EXPORTACIÓN

DURANGO		MOTOR	MODELO	SOPORTE	ESPECIFICACIÓN	No. BUFALO
V8	3.9	98 - 99	MOTOR	FRONTAL / DER / IZQ / REPUESTO	<b>935</b>	
			MOTOR	FRONTAL / IZQ	PRÓXIMAMENTE	
			MOTOR	FRONTAL / DER	PRÓXIMAMENTE	
			TRANSMISIÓN		<b>A2858</b>	
V8	4.7	00 - 03	MOTOR	FRONTAL / DER / IZQ / REPUESTO	<b>935</b>	
			MOTOR	FRONTAL / IZQ / TRACCIÓN TRASERA	PRÓXIMAMENTE	
			MOTOR	FRONTAL / DER / TRACCIÓN TRASERA	PRÓXIMAMENTE	
			MOTOR	FRONTAL / DER / IZQ / REPUESTO	<b>935</b>	
			MOTOR	FRONTAL / IZQ / 4 X 4	PRÓXIMAMENTE	
			MOTOR	FRONTAL / DER / 4 X 4	PRÓXIMAMENTE	
			TRANSMISIÓN	4 X 4	<b>A2858</b>	
		TRANSMISIÓN	TRACCIÓN TRASERA	PRÓXIMAMENTE		
	04 - 07	TRANSMISIÓN	AUT	PRÓXIMAMENTE		
V8	5.2	98 - 99	MOTOR	FRONTAL / IZQ	PRÓXIMAMENTE	
			MOTOR	FRONTAL / DER	PRÓXIMAMENTE	
		98 - 00	MOTOR	FRONTAL / DER / REPUESTO	<b>935</b>	
			TRANSMISIÓN	TRACCIÓN TRASERA	<b>743</b>	
		00	TRANSMISIÓN	4 X 4	<b>A2858</b>	
			MOTOR	FRONTAL / IZQ	<b>A2829</b>	
		MOTOR	FRONTAL / DER	PRÓXIMAMENTE		
V8	5.7	04 - 07	TRANSMISIÓN	FRONTAL / IZQ	PRÓXIMAMENTE	
V8	5.9	98 - 99	MOTOR	FRONTAL / IZQ	PRÓXIMAMENTE	
			MOTOR	FRONTAL / DER	PRÓXIMAMENTE	
		98 - 03	MOTOR	FRONTAL / DER / IZQ / REPUESTO	<b>935</b>	
			TRANSMISIÓN	TRACCIÓN TRASERA	PRÓXIMAMENTE	
		00 - 03	TRANSMISIÓN	4 X 4	<b>A2858</b>	
			MOTOR	FRONTAL / IZQ	<b>A2829</b>	
			MOTOR	FRONTAL / DER	PRÓXIMAMENTE	
			MOTOR	TRASERO / IZQ	PRÓXIMAMENTE	
		MOTOR	TRASERO / DER	PRÓXIMAMENTE		

<b>743</b>	<b>935</b>	<b>A2829</b>	<b>A2858</b>	PRÓXIMAMENTE	PRÓXIMAMENTE	PRÓXIMAMENTE
PRÓXIMAMENTE	PRÓXIMAMENTE	PRÓXIMAMENTE	PRÓXIMAMENTE	PRÓXIMAMENTE	PRÓXIMAMENTE	



# D O D G E

**TODO TERRENO**

JOURNEY	MOTOR	MODELO	SOPORTE	ESPECIFICACIÓN	No. BUFALO
	L4 2.0 2.4	07 - 11	MOTOR	FRONTAL / REPUESTO	PRÓXIMAMENTE
			MOTOR	FRONTAL	PRÓXIMAMENTE
			MOTOR	FRONTAL / DER	<b>A5085476AC</b>
			MOTOR	TRASERO / REPUESTO	PRÓXIMAMENTE
			MOTOR	TRASERO	PRÓXIMAMENTE
			TRANSMISIÓN	STD / REPUESTO	PRÓXIMAMENTE
			TRANSMISIÓN	STD	PRÓXIMAMENTE
			TRANSMISIÓN	AUT / REPUESTO	PRÓXIMAMENTE
			TRANSMISIÓN	AUT	PRÓXIMAMENTE



RAM CHARGER	MOTOR	MODELO	SOPORTE	ESPECIFICACIÓN	No. BUFALO
V6	3.7	74 - 85	TRANSMISIÓN		<b>743</b>
		74 - 94	MOTOR	FRONTAL / DER / IZQ	<b>741</b>
		86 - 94	TRANSMISIÓN		<b>825</b>
V6	5.2	74 - 85	TRANSMISIÓN		<b>743</b>
		74 - 94	MOTOR	FRONTAL / DER / IZQ	<b>741</b>
	7.2	86 - 94	TRANSMISIÓN		<b>863</b>
			TRANSMISIÓN		<b>825</b>



# D O D G E

**PICK UP**

D100 / D200 D250 / D300 D350	MOTOR	MODELO	SOPORTE	ESPECIFICACIÓN	No. BUFALO
L6	3.7	69 - 74	MOTOR	FRONTAL / DER / IZQ	<b>568</b>
			TRANSMISIÓN		<b>575</b>
V6	3.9	74 - 94	MOTOR	DER / IZQ / 318 / 360 / 361 / 440	<b>840</b>
			MOTOR	FRONTAL / DER / IZQ	<b>741</b>
L6	4.0	86 - 94	TRANSMISIÓN	TRABAJO PESADO	<b>735</b>
			TRANSMISIÓN	TRABAJO PESADO	<b>863</b>
V8	5.7	90 - 94	TRANSMISIÓN		<b>862</b>

CONTINÚA...



D100 / D200 D250 / D300 D350 / D500	MOTOR	MODELO	SOPORTE	ESPECIFICACIÓN	No. BUFALO
	V6	61 - 78		TRANSMISIÓN	TRASERO
V8	MOTOR			225 / 318 / 360 / 361	<b>541</b>
		61 - 74	MOTOR	DER / IZQ / 225 / 318 / 360 / 361	<b>542</b>

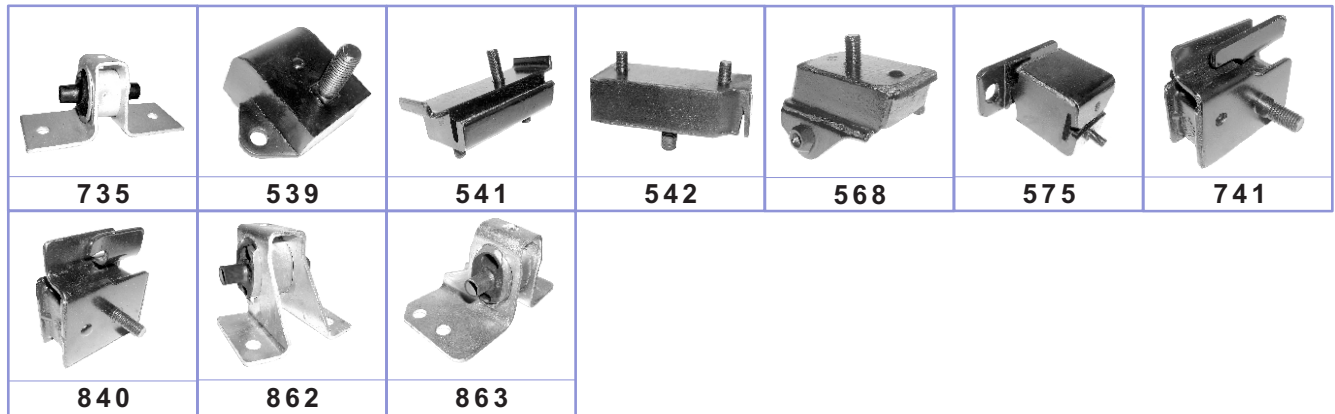

DAKOTA	MOTOR	MODELO	SOPORTE	ESPECIFICACIÓN	No. BUFALO
V8	3.7	04 - 05	MOTOR	FRONTAL / DER / IZQ / REPUESTO	<b>935</b>
			MOTOR	FRONTAL / IZQ	PRÓXIMAMENTE
			MOTOR	FRONTAL / DER	PRÓXIMAMENTE
			TRANSMISIÓN	4 X 4	<b>A2858</b>
			TRANSMISIÓN	TRACCIÓN TRASERA	<b>825</b>
V6	3.9 4 X 4	92 - 93	TRANSMISIÓN		<b>A2570</b>
		94 - 04	TRANSMISIÓN		<b>A2858</b>
		97 - 03	MOTOR	FRONTAL / DER / IZQ / REPUESTO	<b>935</b>
			MOTOR	FRONTAL / IZQ	PRÓXIMAMENTE
			MOTOR	FRONTAL / DER	PRÓXIMAMENTE
V6	3.9 TRACCIÓN TRASERA	87 - 96	MOTOR	FRONTAL / DER / IZQ	<b>1013</b>
		87 - 03	TRANSMISIÓN		<b>825</b>
		91 - 96	TRANSMISIÓN	STD	<b>A2954</b>
		97 - 03	MOTOR	FRONTAL / DER / IZQ / REPUESTO	<b>935</b>
			MOTOR	FRONTAL / IZQ	PRÓXIMAMENTE
			MOTOR	FRONTAL / DER	PRÓXIMAMENTE
V8	4.7	00 - 04	MOTOR	FRONTAL / DER / IZQ / REPUESTO	<b>935</b>
			MOTOR	FRONTAL / IZQ / 4 X 4	PRÓXIMAMENTE
			MOTOR	FRONTAL / DER / 4 X 4	PRÓXIMAMENTE
			MOTOR	FRONTAL / DER / IZQ / REPUESTO	<b>935</b>
			MOTOR	FRONTAL / IZQ / TRACCIÓN TRASERA	PRÓXIMAMENTE
			MOTOR	FRONTAL / DER / TRACCIÓN TRASERA	PRÓXIMAMENTE
			TRANSMISIÓN	TRACCIÓN TRASERA	PRÓXIMAMENTE
			TRANSMISIÓN	4 X 4	<b>A2858</b>



# D O D G E

PICK UP

DAKOTA	MOTOR	MODELO	SOPORTE	ESPECIFICACIÓN	No. BUFALO
	<b>V8 5.2 4 X 4</b>	<b>97 - 99</b>	MOTOR	FRONTAL / DER / IZQ / REPUESTO	<b>935</b>
			MOTOR	FRONTAL / IZQ	PRÓXIMAMENTE
			MOTOR	FRONTAL / DER / AUT / STD	PRÓXIMAMENTE
			TRANSMISIÓN		<b>A2858</b>
<b>TRACCIÓN TRASERA</b>	<b>V8 5.2</b>	<b>89 - 93</b>	TRANSMISIÓN		<b>825</b>
		<b>89 - 96</b>	MOTOR	FRONTAL / DER / IZQ	<b>1013</b>
		<b>94 - 96</b>	TRANSMISIÓN	AUT / STD	<b>A2954</b>
		<b>97 - 99</b>	MOTOR	FRONTAL / DER / IZQ / REPUESTO A2829	<b>935</b>
			MOTOR	FRONTAL / IZQ	<b>A2829</b>
			MOTOR	FRONTAL / DER	PRÓXIMAMENTE
			TRANSMISIÓN	AUT / STD	<b>A2991</b>
<b>TRACCIÓN TRASERA</b>	<b>V8 5.9 4 X 4</b>	<b>89 - 96</b>	MOTOR	FRONTAL / DER / IZQ / REPUESTO	<b>935</b>
			MOTOR	FRONTAL / IZQ	PRÓXIMAMENTE
			MOTOR	FRONTAL / DER	PRÓXIMAMENTE
		<b>94 - 96</b>	TRANSMISIÓN		<b>A2858</b>
		<b>97 - 99</b>	MOTOR	FRONTAL / IZQ	PRÓXIMAMENTE
			MOTOR	FRONTAL / DER	PRÓXIMAMENTE
<b>TRACCIÓN TRASERA</b>	<b>V8 5.9</b>	<b>98 - 99</b>	TRANSMISIÓN		<b>A2991</b>
		<b>89 - 96</b>	MOTOR	FRONTAL / DER / IZQ / REPUESTO A2829	<b>935</b>
			MOTOR	FRONTAL / IZQ	<b>A2829</b>
			TRANSMISIÓN	FRONTAL / DER	PRÓXIMAMENTE
		<b>94 - 96</b>	TRANSMISIÓN		PRÓXIMAMENTE

						
<b>825</b>	<b>935</b>	<b>1013</b>	<b>A2570</b>	<b>A2829</b>	<b>A2858</b>	<b>A2954</b>
						
<b>A2991</b>	PRÓXIMAMENTE	PRÓXIMAMENTE	PRÓXIMAMENTE	PRÓXIMAMENTE	PRÓXIMAMENTE	PRÓXIMAMENTE
						
PRÓXIMAMENTE	PRÓXIMAMENTE	PRÓXIMAMENTE	PRÓXIMAMENTE			

FARGO 100 FARGO 200	MOTOR	MODELO	SOPORTE	ESPECIFICACIÓN	No. BUFALO
	V8	97 - 99	MOTOR	FRONTAL / DER / IZQ / REPUESTO	539



H 100	MOTOR	MODELO	SOPORTE	ESPECIFICACIÓN	No. BUFALO
	1.5	03 - 10	MOTOR	FRONTAL / DER / IZQ	PRÓXIMAMENTE
L4	1.6		TRANSMISIÓN	DIESEL / GASOLINA / REPUESTO	PRÓXIMAMENTE
			TRANSMISIÓN	DIESEL / GASOLINA	PRÓXIMAMENTE

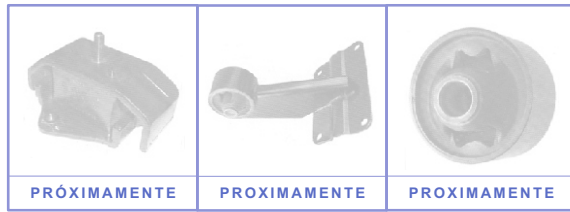

RAM 50	MOTOR	MODELO	SOPORTE	ESPECIFICACIÓN	No. BUFALO
L4	2.0	79 - 89	MOTOR	FRONTAL / DER / IZQ	971
			TRANSMISIÓN		A 2730
		82 - 89	MOTOR	FRONTAL / DER / IZQ / 4 X 4	PRÓXIMAMENTE
L4	2.3	83 - 85	MOTOR	FRONTAL / IZQ	971
			MOTOR	FRONTAL / DER	PRÓXIMAMENTE
L4	2.4	90 - 93	MOTOR	FRONTAL / IZQ / 4 X 4	PRÓXIMAMENTE
			MOTOR	FRONTAL / DER / 4 X 4	PRÓXIMAMENTE
			MOTOR	FRONTAL / DER / IZQ	971
			TRANSMISIÓN	STD / 2 X 2	A 2730
L4	2.6	79 - 89	MOTOR	FRONTAL / DER / IZQ / TRACCIÓN TRASERA	PRÓXIMAMENTE
		87	MOTOR	FRONTAL / DER / IZQ	PRÓXIMAMENTE
		87 - 89	MOTOR	FRONTAL / IZQ / 4 X 4	PRÓXIMAMENTE
			MOTOR	FRONTAL / DER / 4 X 4	971
			TRANSMISIÓN		A 2730





**D O D G E**

**PICK UP**

RAM 1500 RAM 2500	MOTOR	MODELO	SOPORTE	ESPECIFICACIÓN	No. BUFALO
V6	3.9	94 - 01	MOTOR	FRONTAL / DER / IZQ/ REPUESTO A2829 Y A2830	PRÓXIMAMENTE
			MOTOR	FRONTAL / DER	<b>A2830</b>
	5.2		MOTOR	FRONTAL / IZQ	<b>A2829</b>
	5.9		TRANSMISIÓN	MOT. 3.9	<b>825</b>
			TRANSMISIÓN	MOT. 5.2 Y 5.9	<b>885</b>

V8	4.7	02 - 05	MOTOR	FRONTAL / IZQ	PRÓXIMAMENTE
	5.7		MOTOR	FRONTAL / DER	PRÓXIMAMENTE
		5.9	MOTOR		PRÓXIMAMENTE
4 X 4 GASOLINA	02 - 08	TRANSMISIÓN	FRONTAL / IZQ / REPUESTO 1	PRÓXIMAMENTE	
		TRANSMISIÓN	FRONTAL / DER / REPUESTO	PRÓXIMAMENTE	
	06 - 08	TRANSMISIÓN	STD / TRACCIÓN TRASERA	PRÓXIMAMENTE	



RAM 3500 RAM 4000	MOTOR	MODELO	SOPORTE	ESPECIFICACIÓN	No. BUFALO
V8	5.9	03 - 08	MOTOR	FRONTAL / DER / IZQ / TURBO / GASOLINA / DIESEL	PRÓXIMAMENTE
			TRANSMISIÓN	TURBO / GASOLINA / DIESEL	PRÓXIMAMENTE



# CALIDAD Y GARANTÍA DE EXPORTACIÓN

# D O D G E

**CAMIONETAS VAN**



MR

PACIFICA	MOTOR	MODELO	SOPORTE	ESPECIFICACIÓN	No. <i>BUFALO</i>
V6	3.5	04 - 06	MOTOR	TORSIÓN / TRASERA	PRÓXIMAMENTE
			TRANSMISIÓN		PRÓXIMAMENTE
V6	3.8	07 - 08	MOTOR	TORSIÓN / TRASERA	PRÓXIMAMENTE

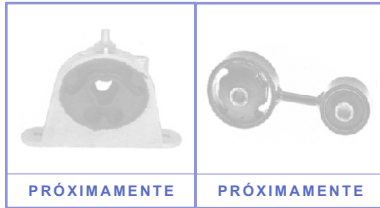

PRÓXIMAMENTE

PRÓXIMAMENTE

TOWN & COUNTRY	MOTOR	MODELO	SOPORTE	ESPECIFICACIÓN	No. <i>BUFALO</i>			
	V6	90 - 95	MOTOR	FRONTAL / INF / <i>REPUESTO</i>	850			
			MOTOR	FRONTAL / INF	PRÓXIMAMENTE			
			MOTOR	FRONTAL / DER	852			
			MOTOR	FRONTAL / DER	A2711			
			TRANSMISIÓN	<i>REPUESTO</i>	851			
			TRANSMISIÓN		PRÓXIMAMENTE			
		96 - 00	3.3	96 - 00	MOTOR	FRONTAL / DER / <i>REPUESTO A2959</i>	992	
					MOTOR	FRONTAL / DER	A2959	
			3.8	96 - 00	TRANSMISIÓN	FRONTAL / IZQ / <i>REPUESTO A2960</i>	958	
					TRANSMISIÓN	FRONTAL / IZQ	A2960	
					TRANSMISIÓN	CENTRAL / AUT / <i>REPUESTO A2984</i>	957	
					TRANSMISIÓN	CENTRAL / AUT	A2984	
			01 - 07	3.8	01 - 07	TRANSMISIÓN	TRASERO / IZQ / <i>REPUESTO</i>	958
						TRANSMISIÓN	TRASERO / IZQ	A2849-C
		MOTOR				FRONTAL / DER	1075	
		TRANSMISIÓN				FRONTAL / IZQ / <i>REPUESTO A2928</i>	1089	
		TRANSMISIÓN				FRONTAL / IZQ	A2928	
		TRANSMISIÓN				CENTRAL / <i>REPUESTO A2925</i>	1090	
					TRANSMISIÓN	CENTRAL	A2984	
					TRANSMISIÓN	TRASERO / IZQ	A2928	

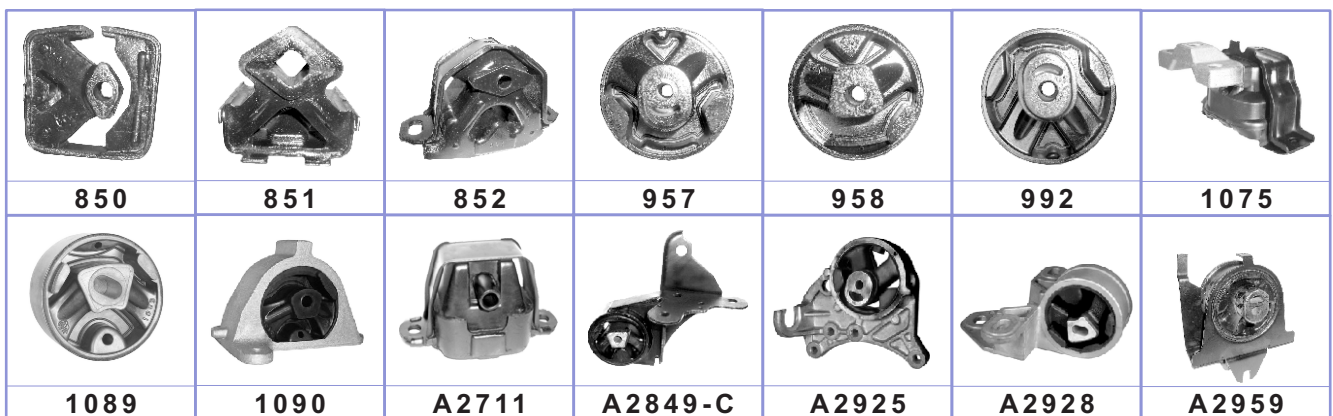

CONTINÚA...



MR

# D O D G E

## CAMIONETAS VAN

TOWN & COUNTRY			
			
<b>A2960</b>	<b>A2984</b>	PRÓXIMAMENTE	PRÓXIMAMENTE

VOYAGER GRAND VOYAGER CARAVAN GRAND CARAVAN	MOTOR	MODELO	SOPORTE	ESPECIFICACIÓN	No. BUFALO
L4	2.2	84 - 89	MOTOR	FRONTAL / INF / REPUESTO 894	<b>793</b>
			MOTOR	FRONTAL / INF	<b>894</b>
			MOTOR	FRONTAL / DER	<b>788</b>
			MOTOR	TORSIÓN / FRONTAL / STD	<b>791</b>
			TRANSMISIÓN		<b>806</b>
L4	2.4	96 - 99	MOTOR	CENTRAL	<b>A2984</b>
			MOTOR	FRONTAL / DER / REPUESTO A2959	<b>992</b>
			MOTOR	FRONTAL / DER	<b>A2959</b>
			TRANSMISIÓN	FRONTAL / IZQ / REPUESTO A2960	<b>958</b>
		96 - 00	TRANSMISIÓN	FRONTAL / IZQ	<b>A2960</b>
			TRANSMISIÓN	CENTRAL / REPUESTO A2984 Y A2925	<b>957</b>
			TRANSMISIÓN	TRASERO / IZQ / REPUESTO	<b>958</b>
			TRANSMISIÓN	TRASERO / IZQ	<b>A2849-C</b>
			TRANSMISIÓN	CENTRAL	<b>A2925</b>
L4	2.5	87 - 90	MOTOR	FRONTAL / INF / REPUESTO 894	<b>793</b>
			MOTOR	FRONTAL / INF	<b>894</b>
			MOTOR	FRONTAL / DER	<b>788</b>
			TRANSMISIÓN		<b>806</b>
		91 - 95	MOTOR	FRONTAL / INF / REPUESTO	<b>850</b>
			MOTOR	FRONTAL / INF	PRÓXIMAMENTE
			MOTOR	FRONTAL / DER	<b>852</b>
			TRANSMISIÓN	REPUESTO	<b>851</b>
			TRANSMISIÓN		PRÓXIMAMENTE
			V6	3.0	87 - 89
MOTOR	FRONTAL / INF	<b>894</b>			
MOTOR	FRONTAL / DER	<b>788</b>			
TRANSMISIÓN		<b>806</b>			
90 - 95	MOTOR	FRONTAL / INF / REPUESTO	<b>850</b>		
	MOTOR	FRONTAL / INF	PRÓXIMAMENTE		
	MOTOR	FRONTAL / DER	<b>852</b>		
	MOTOR	FRONTAL / DER	<b>A2711</b>		
	TRANSMISIÓN	REPUESTO	<b>851</b>		
	TRANSMISIÓN		PRÓXIMAMENTE		

CONTINÚA...

# D O D G E

## CAMIONETAS VAN



MR

VOYAGER GRAND VOYAGER CARAVAN GRAND CARAVAN	MOTOR	MODELO	SOPORTE	ESPECIFICACIÓN	No. <b>BUFALO</b>
	V6 3.0	96 - 00	MOTOR	FRONTAL / DER / <i>REPUESTO A2959</i>	<b>992</b>
			MOTOR	FRONTAL / DER	<b>A2959</b>
			TRANSMISIÓN	FRONTAL / IZQ / <i>REPUESTO A2960</i>	<b>958</b>
			TRANSMISIÓN	FRONTAL / IZQ	<b>A2960</b>
			TRANSMISIÓN	CENTRAL / <i>REPUESTO A2984</i>	<b>957</b>
			TRANSMISIÓN	CENTRAL	<b>A2984</b>
			TRANSMISIÓN	TRASERO / IZQ / <i>REPUESTO A2849-C</i>	<b>958</b>
			TRANSMISIÓN	TRASERO / IZQ	<b>A2849-C</b>

V6	3.0	90 - 95	MOTOR	FRONTAL / INF / <i>REPUESTO</i>	<b>850</b>	
			MOTOR	FRONTAL / INF	<b>PRÓXIMAMENTE</b>	
			MOTOR	FRONTAL / DER	<b>852</b>	
			MOTOR	FRONTAL / DER	<b>A2711</b>	
			TRANSMISIÓN	<i>REPUESTO</i>	<b>851</b>	
			TRANSMISIÓN		<b>PRÓXIMAMENTE</b>	
	3.3	96 - 00	MOTOR	FRONTAL / DER / <i>REPUESTO A2959</i>	<b>992</b>	
			MOTOR	FRONTAL / DER	<b>PRÓXIMAMENTE</b>	
			TRANSMISIÓN	FRONTAL / INF / <i>REPUESTO A2960</i>	<b>958</b>	
			TRANSMISIÓN	FRONTAL / INF	<b>A2960</b>	
			TRANSMISIÓN	CENTRAL / <i>REPUESTO A2984</i>	<b>957</b>	
			TRANSMISIÓN	CENTRAL	<b>A2984</b>	
	3.8	96 - 00	TRANSMISIÓN	TRASERO / IZQ / <i>REPUESTO A2849-C</i>	<b>958</b>	
			TRANSMISIÓN	TRASERO / IZQ	<b>A2849-C</b>	
			01 - 07	MOTOR	FRONTAL / DER	<b>1075</b>
				TRANSMISIÓN	FRONTAL / IZQ / <i>REPUESTO A2928</i>	<b>1089-A</b>
				TRANSMISIÓN	FRONTAL / IZQ	<b>A2928</b>
				TRANSMISIÓN	CENTRAL / <i>REPUESTO A2925</i>	<b>957</b>
	TRANSMISIÓN	CENTRAL		<b>A2925</b>		
	TRANSMISIÓN	TRASERO / IZQ	<b>1090</b>			

<b>788</b>	<b>791</b>	<b>793</b>	<b>806</b>	<b>850</b>	<b>851</b>	<b>852</b>
<b>894</b>	<b>957</b>	<b>958</b>	<b>992</b>	<b>1075</b>	<b>1089-A</b>	<b>1090</b>
<b>A2711</b>	<b>A2849-C</b>	<b>A2925</b>	<b>A2928</b>	<b>A2959</b>	<b>A2960</b>	<b>A2984</b>



**D O D G E**

**CAMIONETAS VAN**

VOYAGER  
GRAND VOYAGER  
CARAVAN  
GRAND CARAVAN

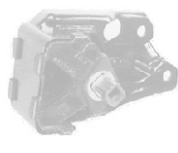

PRÓXIMAMENTE

PRÓXIMAMENTE



**MR**

# **CALIDAD Y GARANTÍA DE EXPORTACIÓN**



# F O R D

**AUTOS**



CONTOUR	MOTOR	MODELO	SOPORTE	ESPECIFICACIÓN	No. BUFALO
L4	2.0	95 - 97	MOTOR	FRONTAL / AUT / 4 VEL. / 24 mm. DIÁMETRO	975
			MOTOR	FRONTAL / DER / REPUESTO	914
			MOTOR	FRONTAL / DER	PRÓXIMAMENTE
			TRANSMISIÓN	TRASERO	A2887
			TRANSMISIÓN		A2887-C
		95 - 00	MOTOR	FRONTAL / STD / 5 VEL.	A2978
			MOTOR	FRONTAL / IZQ	A2886-C
			TRANSMISIÓN	CENTRAL / REPUESTO	913
			TRANSMISIÓN	CENTRAL / AUT / 4 VEL / STD / 5 VEL	PRÓXIMAMENTE
		98 - 00	MOTOR	FRONTAL / AUT / 4 VEL / 20 mm. DIÁMETRO	A2885
			MOTOR		A2885-C
			MOTOR	FRONTAL / DER	1105
			TRANSMISIÓN	TRASERO	915
			TRANSMISIÓN	IZQ / AUT	A5209

L4	2.5	95 - 97	MOTOR	FRONTAL / AUT / 4 VEL. / 24 mm. DIÁMETRO	975
			MOTOR	FRONTAL / STD / 5 VEL	A2978
			MOTOR	FRONTAL / DER / REPUESTO	914
			MOTOR	FRONTAL / DER	PRÓXIMAMENTE
			TRANSMISIÓN	TRASERO	A2887
		95 - 00	TRANSMISIÓN	CENTRAL / REPUESTO	913
			TRANSMISIÓN	CENTRAL	PRÓXIMAMENTE
			TRANSMISIÓN	AUT / STD	915
		98 - 00	MOTOR	FRONTAL / 4 VEL / 20 mm. DIÁMETRO	A2885
			MOTOR	FRONTAL / STD / 5 VEL	915
			TRANSMISIÓN	IZQ / AUT	A5209

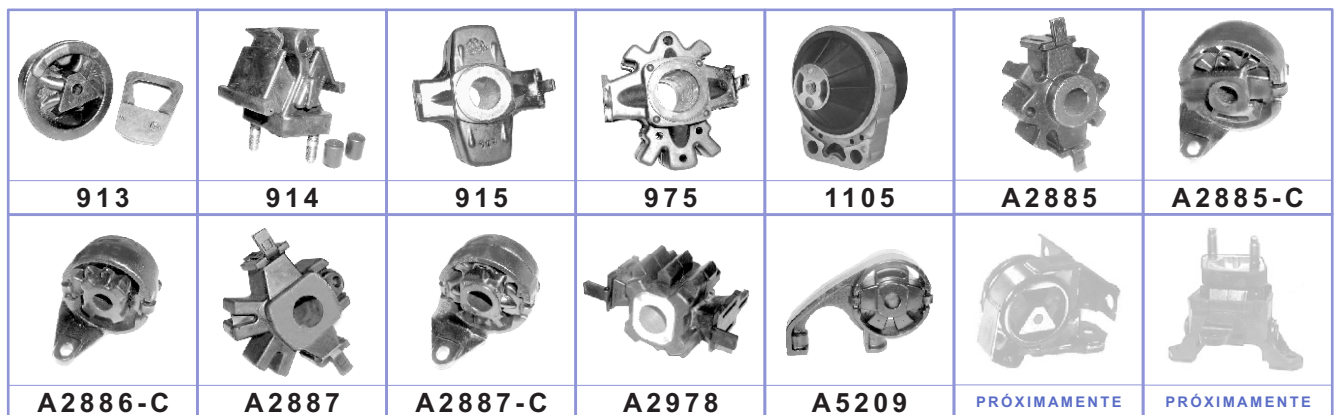

# CALIDAD Y GARANTÍA

**Autopartes Hule - Metal**



# F O R D

---

**AUTOS**

COUGAR MEX	MOTOR	MODELO	SOPORTE	ESPECIFICACIÓN	No. BUFALO
	L6 3.3	80 - 92	MOTOR	FRONTAL / DER / IZQ	PRÓXIMAMENTE
			TRANSMISIÓN		790

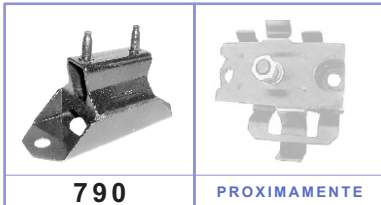

COUGAR "MERCURY"	MOTOR	MODELO	SOPORTE	ESPECIFICACIÓN	No. BUFALO
	V6 3.8	82 - 86	TRANSMISIÓN	AUT	790
		86 - 97	MOTOR	FRONTAL / DER / IZQ	855
	V8 5.0	87 - 97	MOTOR		A2707

V6 3.8	85 - 87	MOTOR	FRONTAL / IZQ	904
		MOTOR	FRONTAL / DER	905

V8 5.8	74 - 79	MOTOR	FRONTAL / DER	A2364
		MOTOR	FRONTAL / IZQ	A2365
	77 - 79	MOTOR	FRONTAL / DER	A2370
		MOTOR	FRONTAL / IZQ	A2371

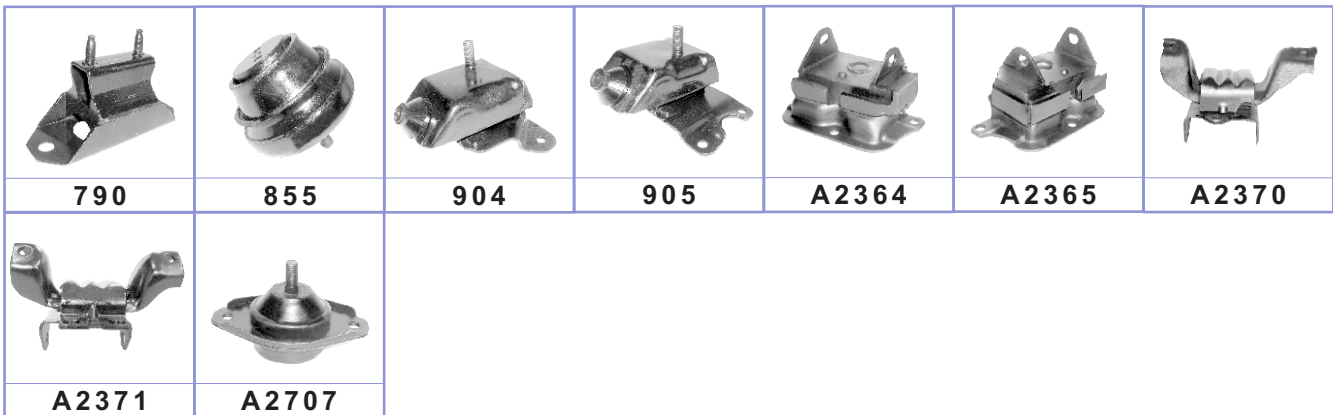

COUGAR USA	MOTOR	MODELO	SOPORTE	ESPECIFICACIÓN	No. BUFALO
	L4 2.0	99 - 02	MOTOR	FRONTAL / STD / 5 VEL.	915
			MOTOR	FRONTAL / AUT / 4 VEL. / 20 mm. DIÁMETRO	A2885
			MOTOR	FRONTAL / IZQ	A2978
			MOTOR	FRONTAL / DER	1105
			TRANSMISIÓN	FRONTAL / REPUESTO	913
			TRANSMISIÓN	FRONTAL	PRÓXIMAMENTE
			TRANSMISIÓN	TRASERO / AUT	915

CONTINÚA...

COUGAR USA			MOTOR	FRONTAL / IZQ / STD / 5 VEL.	<b>A 2978</b>
V6	2.5	99 - 02	MOTOR	FRONTAL / IZQ / AUT / 4 VEL. / 20 mm. DIÁMETRO	<b>A 2885</b>
			TRANSMISIÓN	FRONTAL / REPUESTO	<b>913</b>
			TRANSMISIÓN	FRONTAL / AUT	<b>PRÓXIMAMENTE</b>
			TRANSMISIÓN	TRASERO	<b>915</b>
			TRANSMISIÓN		

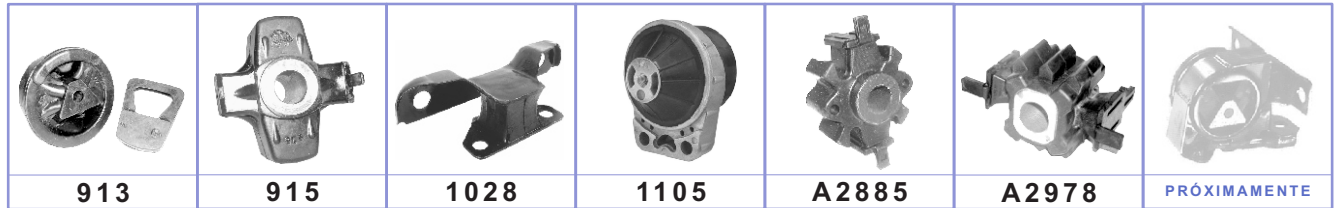

COUGAR XR7			MOTOR	FRONTAL / IZQ	<b>A 2500</b>
V8	5.8	80 - 82	MOTOR	FRONTAL / DER	<b>A 2501</b>
			MOTOR	FRONTAL / IZQ	<b>A 2725</b>
	6.0	94 - 95	MOTOR	FRONTAL / DER	<b>A 2726</b>
			MOTOR		

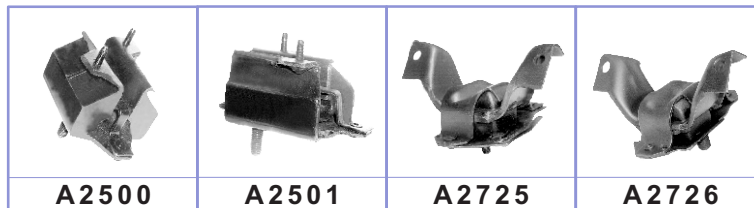

COUGAR "SUPER CARGADO"			MOTOR	HIDRÁULICO	<b>A 2995</b>
V8	4.0 4.6 5.0	87 - 94			



CROWN VICTORIA		MOTOR	MODELO	SOPORTE	ESPECIFICACIÓN	No. <i>BUFALO</i>
V8	4.6	92 - 97	MOTOR	FRONTAL / IZQ		<b>A 2807</b>
			MOTOR	FRONTAL / DER		<b>A 2806</b>
			TRANSMISIÓN			<b>928-A</b>
		98 - 02	MOTOR	FRONTAL / IZQ		<b>A 5218</b>
			MOTOR	FRONTAL / DER		<b>A 5217</b>
		03 - 07	MOTOR	FRONTAL / IZQ		<b>PRÓXIMAMENTE</b>
			MOTOR	FRONTAL / DER		<b>PRÓXIMAMENTE</b>
			TRANSMISIÓN			<b>PRÓXIMAMENTE</b>

CONTINÚA...



# F O R D

**AUTOS**

<b>CROWN VICTORIA</b>	MOTOR	MODELO	SOPORTE	ESPECIFICACIÓN	No. BUFALO
V8	5.0	87 - 91	MOTOR	FRONTAL / DER	<b>A 2438</b>
			MOTOR	FRONTAL / IZQ	<b>A 2437</b>
	5.8		TRANSMISIÓN		<b>928 - A</b>

<b>928 - A</b>	<b>A2437</b>	<b>A2438</b>	<b>A2806</b>	<b>A2807</b>	<b>A5217</b>	<b>A5218</b>
<b>PRÓXIMAMENTE</b>	<b>PRÓXIMAMENTE</b>	<b>PRÓXIMAMENTE</b>				

<b>ESCORT EXP</b>	MOTOR	MODELO	SOPORTE	ESPECIFICACIÓN	No. BUFALO
L4	1.6	81 - 83	MOTOR	FRONTAL / AUT / 3 VEL	<b>PRÓXIMAMENTE</b>
			MOTOR	FRONTAL / STD / 4 VEL	<b>PRÓXIMAMENTE</b>
		84 - 85	MOTOR	FRONTAL	<b>A 2559</b>
			MOTOR	FRONTAL / DER	<b>792 - A</b>
			TRANSMISIÓN	STD / 5 VEL	<b>938</b>
			TRANSMISIÓN	AUT	<b>897 - A</b>
	1.9	85 - 90	MOTOR	FRONTAL	<b>A 2559</b>
MOTOR			FRONTAL / DER	<b>792 - A</b>	
MOTOR			FRONTAL / DER / CON BASE	<b>792</b>	
TRANSMISIÓN			STD	<b>938</b>	
			TRANSMISIÓN	AUT	<b>897 - A</b>

<b>792</b>	<b>792 - A</b>	<b>897 - A</b>	<b>938</b>	<b>A2559</b>	<b>PRÓXIMAMENTE</b>	<b>PRÓXIMAMENTE</b>

<b>ESCORT</b>	MOTOR	MODELO	SOPORTE	ESPECIFICACIÓN	No. BUFALO
L4	1.8	91 - 93	MOTOR	AUT / MOT. 1.8	<b>964</b>
			MOTOR	FRONTAL / REPUESTO 964	<b>964 - R</b>
			MOTOR	STD	<b>964</b>
		91 - 96	MOTOR	FRONTAL / DER / REPUESTO A2649	<b>921</b>
			MOTOR	FRONTAL / DER	<b>A 2649</b>
			MOTOR	TRASERO / IZQ / REPUESTO A2650	<b>920</b>
			MOTOR	TRASERO / IZQ	<b>A 2650</b>

ESCORT	MOTOR	MODELO	SOPORTE	ESPECIFICACIÓN	No. BUFALO
L4	1.8	91 - 96	TRANSMISIÓN	REPUESTO 963	963-R
			TRANSMISIÓN		963
	1.9	94 - 96	MOTOR	FRONTAL / AUT / MOT. 1.8	978

L4	2.0	97 - 03	MOTOR	FRONTAL / AUT / 4 VEL / REPUESTO 978	978-R
			MOTOR	FRONTAL / AUT / 4 VEL	978
			MOTOR	FRONTAL / REPUESTO 964	964-R
			MOTOR	FRONTAL	964
			MOTOR	FRONTAL / DER / REPUESTO A2649	921
			MOTOR	FRONTAL / DER	A2649
			MOTOR	TRASERO / REPUESTO A2650	920
			MOTOR	TRASERO / AUT	A2650
			MOTOR	TRASERO / STD	A2912
			TRANSMISIÓN	AUT / STD	963

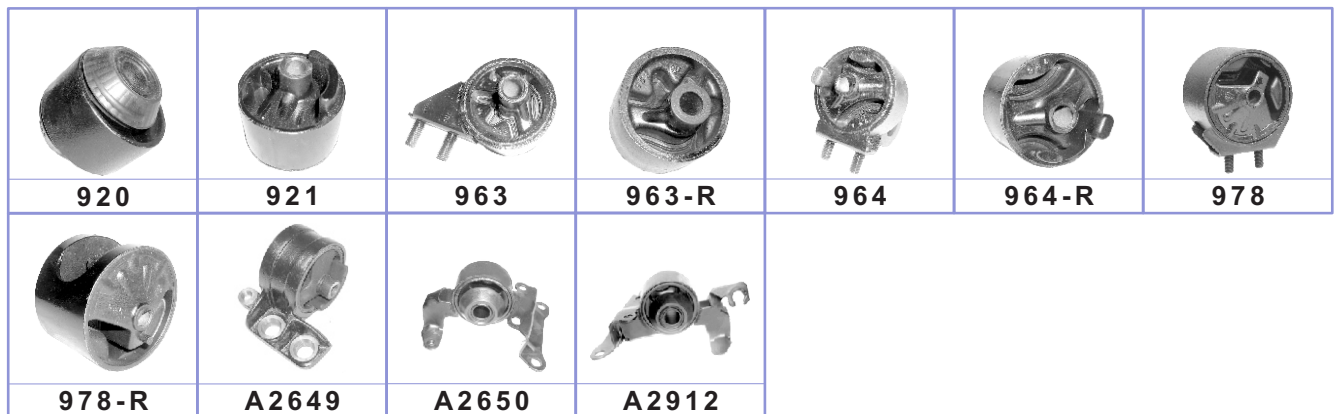

FAIRMONT	MOTOR	MODELO	SOPORTE	ESPECIFICACIÓN	No. BUFALO
L6	3.3	78 - 84	MOTOR	FRONTAL / DER / IZQ	PRÓXIMAMENTE

V8	4.2	78 - 84	MOTOR	FRONTAL / IZQ / 302	739
			MOTOR	FRONTAL / IZQ / 302	739-A
			MOTOR	FRONTAL / DER / 302	740
			MOTOR	FRONTAL / DER / 302	740-A
			MOTOR	AUT / STD	790
			TRANSMISIÓN	STD / 302	810





# F O R D

**AUTOS**

FALCÓN	MOTOR	MODELO	SOPORTE	ESPECIFICACIÓN	No. BUFALO
V6	62 - 66		MOTOR	FRONTAL / IZQ	<b>598</b>
			MOTOR	FRONTAL / DER	<b>599</b>
V6 V8	63 - 67		MOTOR	FRONTAL / IZQ / 260 / 289	<b>513</b>
			MOTOR	FRONTAL / DER / 260 / 289	<b>514</b>
			MOTOR	FRONTAL / DER / IZQ / 302 / 351	<b>515</b>
V8 (TODOS)	63 - 64		MOTOR	FRONTAL / IZQ / 352 / 390 / 406 / 427	<b>715</b>
			MOTOR	FRONTAL / DER / 352 / 390 / 406 / 427	<b>716</b>



FALCON 70	MOTOR	MODELO	SOPORTE	ESPECIFICACIÓN	No. BUFALO
V6	69 - 73		MOTOR	FRONTAL / DER / IZQ / 302	<b>5186</b>



FESTIVA	MOTOR	MODELO	SOPORTE	ESPECIFICACIÓN	No. BUFALO
L4	1.3	88 - 93	MOTOR	FRONTAL	PRÓXIMAMENTE
			MOTOR	FRONTAL / DER	PRÓXIMAMENTE
			TRANSMISIÓN		PRÓXIMAMENTE



FIESTA	MOTOR	MODELO	SOPORTE	ESPECIFICACIÓN	No. BUFALO
HATCHBACK SEDAN	L4	98 - 02	MOTOR	FRONTAL	PRÓXIMAMENTE
			MOTOR	FRONTAL / DER	<b>1040</b>
			MOTOR	FRONTAL / DER	PRÓXIMAMENTE
			MOTOR	FRONTAL / DER	<b>1022</b>
			MOTOR	FRONTAL / DER	PRÓXIMAMENTE
			MOTOR	FRONTAL / DER	<b>1068</b>
			TRANSMISIÓN	FRONTAL / DER / REPUESTO 1024-C	<b>1024</b>
	TRANSMISIÓN	FRONTAL / DER	<b>1024-C</b>		

CONTINÚA...

# F O R D

**AUTOS**



MR

FIESTA HATCHBACK SEDAN	MOTOR	MODELO	SOPORTE	ESPECIFICACIÓN	No. BUFALO
	L4 1.6	03 - 10	MOTOR	FRONTAL / DER	<b>1062-A</b>
			MOTOR	TORSIÓN / TRASERO	PRÓXIMAMENTE
			MOTOR	TORSIÓN / TRASERO / STD	<b>1074-A</b>
			TRANSMISIÓN	IZQ / REPUESTO 1024-C	<b>1024</b>
			TRANSMISIÓN	IZQ	<b>1024-C</b>
			TRANSMISIÓN		<b>1073</b>

L4 2.0	02 - 08	MOTOR	TRASERO / STD	<b>1074-A</b>
--------	---------	-------	---------------	---------------



FOCUS	MOTOR	MODELO	SOPORTE	ESPECIFICACIÓN	No. BUFALO
	L4 2.0	00 - 06	MOTOR	TRASERO	<b>961</b>
			MOTOR	FRONTAL / DER / ÁRBOL DE LEVAS SENCILLO	<b>996-A</b>
			MOTOR	FRONTAL / DER / ÁRBOL DE LEVAS	<b>996</b>
		05 - 06	MOTOR	FRONTAL / EDICIÓN SUVT DEPORTIVO 2 PUERTAS	PRÓXIMAMENTE
			MOTOR	FRONTAL / DER / DOBLE ÁRBOL DE LEVAS	PRÓXIMAMENTE
			MOTOR	TORSIÓN / TRASERO / DER	<b>A2939</b>
			TRANSMISIÓN	AUT / STD	<b>1001</b>

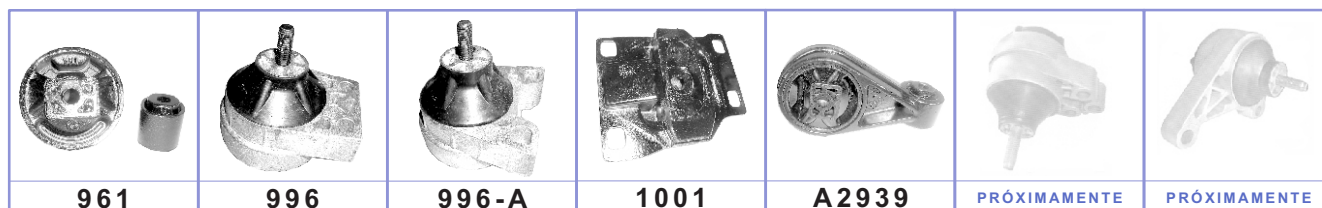







FOCUS "EUROPA"	MOTOR	MODELO	SOPORTE	ESPECIFICACIÓN	No. BUFALO
	L4 2.0	07 - 10	MOTOR	FRONTAL / DER	<b>1110</b>
			MOTOR	TRASERO	<b>1133-A</b>
			MOTOR	TRASERO / REPUESTO	PRÓXIMAMENTE
			MOTOR	TRASERO / AUT / COMPLEMENTO	PRÓXIMAMENTE
			MOTOR	TRASERO / STD / 6 VEL / COMPLEMENTO	PRÓXIMAMENTE
			MOTOR	TRASERO / STD / 5 VEL / COMPLEMENTO	PRÓXIMAMENTE
TRANSMISIÓN		<b>1134-A</b>			

CONTINÚA...



# F O R D

**AUTOS**

<b>FOCUS</b> "EUROPA"						
	<b>1110</b>	<b>1133-A</b>	<b>1134-A</b>	PRÓXIMAMENTE	PRÓXIMAMENTE	PRÓXIMAMENTE
						
PRÓXIMAMENTE						

<b>FOCUS SPORT</b> "EUROPA"	MOTOR	MODELO	SOPORTE	ESPECIFICACIÓN	No. BUFALO
<b>L4</b>	2.0 2.5	<b>07 - 10</b>	MOTOR	FRONTAL / DER	<b>1110</b>
			MOTOR	TRASERO / TRANSMISIÓN SVT MOT. 2.5	<b>1133-A</b>
			MOTOR	TRASERO / REPUESTO	PRÓXIMAMENTE
			MOTOR	TRASERO / AUT / COMPLEMENTO	PRÓXIMAMENTE
			MOTOR	TRASERO / STD / 6 VEL / COMPLEMENTO	PRÓXIMAMENTE
			MOTOR	TRASERO / STD / 5 VEL / COMPLEMENTO	PRÓXIMAMENTE
	TRANSMISIÓN		<b>1134-A</b>		

						
<b>1110</b>	<b>1133-A</b>	<b>1134-A</b>	PRÓXIMAMENTE	PRÓXIMAMENTE	PRÓXIMAMENTE	PRÓXIMAMENTE

<b>FOCUS USA</b>	MOTOR	MODELO	SOPORTE	ESPECIFICACIÓN	No. BUFALO
<b>L4</b>	1.6, 1.8	<b>00 - 06</b>	MOTOR	FRONTAL / DER	PRÓXIMAMENTE
<b>L4</b>	2.3	<b>03 - 06</b>	MOTOR	FRONTAL / DER	<b>1110</b>
			MOTOR	TORSIÓN / TRASERO	<b>A2939</b>
			TRANSMISIÓN		<b>1001</b>

			
<b>1001</b>	<b>1110</b>	<b>A2939</b>	PRÓXIMAMENTE

<b>FUSION</b>	MOTOR	MODELO	SOPORTE	ESPECIFICACIÓN	No. BUFALO
<b>L4</b>	2.3	<b>06 - 08</b>	MOTOR	FRONTAL / DER	PRÓXIMAMENTE
			MOTOR	FRONTAL / AUT	<b>A3105</b>
			MOTOR	FRONTAL / TORSIÓN / INFERIOR / STD / AUT	<b>A3107</b>
			TRANSMISIÓN	REPUESTO A3108	<b>A3108-R</b>
			TRANSMISIÓN		<b>A3108</b>



FUSION	MOTOR	MODELO	SOPORTE	ESPECIFICACIÓN	No. BUFALO
V6	2.5	06 - 09	MOTOR	FRONTAL / IZQ / STD	<b>A 3905</b>
			MOTOR	FRONTAL / DER / STD	<b>A 3906</b>
	3.0		MOTOR	FRONTAL / DER / TIRANTE TRASERO	<b>A 3907</b>
			MOTOR	STD	<b>A 3908</b>
	TRANSMISIÓN			<b>A 3910</b>	
	TRANSMISIÓN			<b>A 3912</b>	



GALAXIE	MOTOR	MODELO	SOPORTE	ESPECIFICACIÓN	No. BUFALO
V8		66 - 69	TRANSMISIÓN	AUT / 302 / 351	<b>517</b>
			TRANSMISIÓN	AUT / 302 / 351	<b>571</b>
		67 - 79	TRANSMISIÓN	STD / 302 / 351	<b>572</b>
			MOTOR	FRONTAL / DER / IZQ / 302 / 351	<b>587</b>

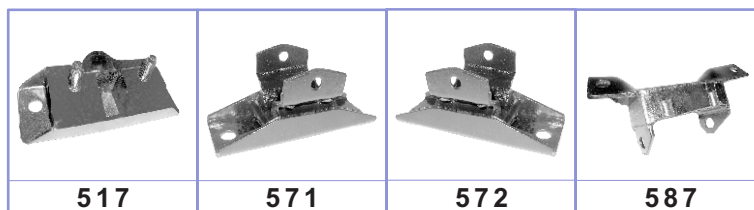

GRAND MARQUIS "MERCURY"	MOTOR	MODELO	SOPORTE	ESPECIFICACIÓN	No. BUFALO
L4	5.0	79 - 91	MOTOR	FRONTAL / DER	<b>A 2437</b>
			MOTOR	FRONTAL / IZQ	<b>A 2438</b>
	5.8		TRANSMISIÓN		<b>769</b>
V6	3.8	83 - 84	MOTOR	FRONTAL / IZQ	<b>A 2500</b>
			MOTOR	FRONTAL / DER	<b>A 2501</b>
V8	4.6	92 - 97	MOTOR	FRONTAL / IZQ	<b>A 2807</b>
			MOTOR	FRONTAL / DER	<b>A 2806</b>
		98 - 02	MOTOR	FRONTAL / IZQ	<b>A 2861</b>
			MOTOR	FRONTAL / DER	<b>A 2860</b>
			TRANSMISIÓN		<b>928 - A</b>



# F O R D

**AUTOS**

GRAND MARQUIS "MERCURY"	MOTOR	MODELO	SOPORTE	ESPECIFICACIÓN	No. BUFALO
V8 4.6	03 - 07	MOTOR	FRONTAL / IZQ	PRÓXIMAMENTE	
		MOTOR	FRONTAL / DER	PRÓXIMAMENTE	
		TRANSMISIÓN	PRÓXIMAMENTE		
		MOTOR	FRONTAL / DER	<b>A 2438</b>	
V8 5.0	79 - 91	MOTOR	FRONTAL / IZQ	<b>A 2437</b>	
		MOTOR	FRONTAL / DER	<b>928 - A</b>	
		TRANSMISIÓN			

<b>769</b>	<b>928-A</b>	<b>A2437</b>	<b>A2438</b>	<b>A2500</b>	<b>A2501</b>	<b>A2806</b>
<b>A2807</b>	<b>A2860</b>	<b>A2861</b>	PRÓXIMAMENTE	PRÓXIMAMENTE	PRÓXIMAMENTE	

IKON	MOTOR	MODELO	SOPORTE	ESPECIFICACIÓN	No. BUFALO
L4 1.6	01 - 07	MOTOR	FRONTAL / DER	PRÓXIMAMENTE	
		MOTOR	FRONTAL / DER / REPUESTO	<b>1040</b>	
		MOTOR	FRONTAL / DER	PRÓXIMAMENTE	
		MOTOR	TORSIÓN / TRASERO	PRÓXIMAMENTE	
		TRANSMISIÓN	REPUESTO 1024-C	<b>1024</b>	
		TRANSMISIÓN		<b>1024-C</b>	

<b>1024</b>	<b>1024-C</b>	<b>1040</b>	PROXIMAMENTE	PROXIMAMENTE	PROXIMAMENTE

# CALIDAD Y GARANTÍA DE EXPORTACIÓN

KA	MOTOR	MODELO	SOPORTE	ESPECIFICACIÓN	No. BUFALO
L4 1.6	01 - 07	MOTOR	FRONTAL	<b>1038</b>	
		MOTOR	FRONTAL / DER	<b>1068</b>	
		MOTOR	TRASERO	<b>PRÓXIMAMENTE</b>	
		MOTOR		<b>1116-A</b>	



LINCOLN LS	MOTOR	MODELO	SOPORTE	ESPECIFICACIÓN	No. BUFALO
V8 3.5 3.9	00 - 06	MOTOR	STD / AIRE ACONDICIONADO	<b>A3107</b>	
		MOTOR	FRONTAL / DER / IZQ	<b>1108</b>	

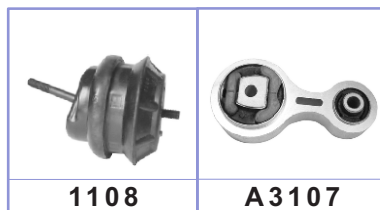

LINX "MERCURY"	MOTOR	MODELO	SOPORTE	ESPECIFICACIÓN	No. BUFALO
L4 1.6	81 - 83	MOTOR	FRONTAL / AUT / 3 VEL	<b>PRÓXIMAMENTE</b>	
		MOTOR	FRONTAL / STD / 4 VEL	<b>PRÓXIMAMENTE</b>	
		MOTOR	FRONTAL	<b>A2559</b>	
		MOTOR	FRONTAL / DER	<b>792-A</b>	
		TRANSMISIÓN	STD / 5 VEL	<b>938</b>	
		TRANSMISIÓN	AUT / REPUESTO	<b>897-A</b>	

L4 1.9	85 - 90	MOTOR	FRONTAL	<b>A2559</b>
		MOTOR	FRONTAL / DER	<b>792-A</b>
		MOTOR	FRONTAL / DER / CON BASE	<b>792</b>
		TRANSMISIÓN	STD	<b>938</b>
		TRANSMISIÓN	AUT	<b>897-A</b>





# F O R D

**AUTOS**

MAVERICK	MOTOR	MODELO	SOPORTE	ESPECIFICACIÓN	No. BUFALO
	V6	70 - 72	MOTOR	AUT / STD / 289 / 302	588
	V8	70 - 77	MOTOR	289 / 302	5187

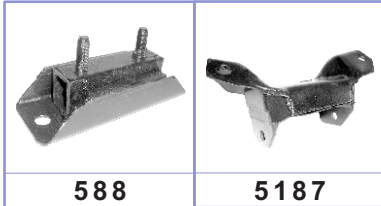

MIRAGE	MOTOR	MODELO	SOPORTE	ESPECIFICACIÓN	No. BUFALO
	L4 1.5	97 - 02	MOTOR	FRONTAL / STD	A9037



MYSTIQUE "MERCURY"	MOTOR	MODELO	SOPORTE	ESPECIFICACIÓN	No. BUFALO
L4 2.0	95 - 97		MOTOR	FRONTAL / AUT / 4 VEL. / 24 mm. DIÁMETRO	975
			MOTOR	FRONTAL / DER / REPUESTO	914
			MOTOR	FRONTAL / DER	PRÓXIMAMENTE
			TRANSMISIÓN	TRASERO	A2887
			TRANSMISIÓN	TRASERO / REPUESTO A2887	A2887-C
			MOTOR	FRONTAL / STD / 5 VEL	A2978
	95 - 00	MOTOR	TRASERO	1095	
		MOTOR	FRONTAL / IZQ	A2886-C	
		TRANSMISIÓN	CENTRAL / REPUESTO	913	
		TRANSMISIÓN	CENTRAL / AUT / 4 VEL / STD / 5 VEL	PRÓXIMAMENTE	
	98 - 00	MOTOR	FRONTAL / AUT / 4 VEL / 20 mm. DIÁMETRO	A2885	
		MOTOR	FRONTAL / AUT / 4 VEL / 20 mm. DIÁMETRO	A2885-C	
		MOTOR	FRONTAL / DER	1105	
		TRANSMISIÓN	TRASERO	915	

L4 2.5	95 - 97		MOTOR	FRONTAL / AUT / 4 VEL. / 24 mm. DIÁMETRO	975
			MOTOR	FRONTAL / STD / 5 VEL	A2978
			MOTOR	FRONTAL / DER / REPUESTO	914
			MOTOR	FRONTAL / DER	PRÓXIMAMENTE
			TRANSMISIÓN	TRASERO	A2887
			TRANSMISIÓN	TRASERO	A2887-C
	95 - 00	TRANSMISIÓN	CENTRAL / REPUESTO	913	
		TRANSMISIÓN	CENTRAL	PRÓXIMAMENTE	
		TRANSMISIÓN	AUT / STD	915	

CONTINÚA...

MYSTIQUE "MERCURY"	MOTOR	MODELO	SOPORTE	ESPECIFICACIÓN	No. BUFALO
L4	2.5	98 - 00	MOTOR	FRONTAL / 4 VEL / 20 mm. DIÁMETRO	<b>A 2885</b>
			MOTOR	FRONTAL / 4 VEL / 20 mm. DIÁMETRO	<b>A 2885</b>
			MOTOR	FRONTAL / STD / 5 VEL	<b>915</b>
			MOTOR	IZQ / AUT	<b>A 5209</b>

<b>913</b>	<b>914</b>	<b>915</b>	<b>975</b>	<b>1095</b>	<b>1105</b>	<b>A2885</b>
<b>A2885-C</b>	<b>A2886-C</b>	<b>A2887</b>	<b>A2887-C</b>	<b>A2978</b>	<b>A5209</b>	<b>PRÓXIMAMENTE</b>
<b>PRÓXIMAMENTE</b>						

MONDEO	MOTOR	MODELO	SOPORTE	ESPECIFICACIÓN	No. BUFALO
L4	2.0	00 - 07	MOTOR	FRONTAL / DER	<b>1105</b>
			MOTOR	TORSIÓN / TRASERO / INFERIOR	<b>1113-A</b>
			TRANSMISIÓN		<b>1117-A</b>

V6	2.5	00 - 07	MOTOR	FRONTAL / DER	<b>PRÓXIMAMENTE</b>
	3.0		MOTOR	TORSIÓN / TRASERO / INFERIOR	<b>1113-A</b>
			TRANSMISIÓN		<b>1117-A</b>

<b>1105</b>	<b>1113-A</b>	<b>1117-A</b>	<b>PRÓXIMAMENTE</b>

















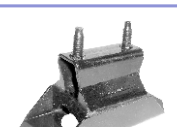
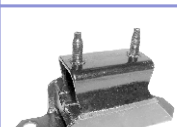

# CALIDAD Y GARANTÍA



# F O R D

**AUTOS**

MUSTANG	MOTOR	MODELO	SOPORTE	ESPECIFICACIÓN	No. BUFALO	
V6		62 - 66	MOTOR	FRONTAL / DER	<b>599</b>	
			MOTOR	FRONTAL / IZQ	<b>598</b>	
		63 - 67	MOTOR	FRONTAL / IZQ / 260 / 289	<b>513</b>	
			MOTOR	FRONTAL / DER / 260 / 289	<b>514</b>	
			67 - 79	MOTOR	FRONTAL / DER / IZQ / 302 / 351	<b>515</b>
			69 - 73	MOTOR	FRONTAL / DER / IZQ / 302	<b>5186</b>
			74	MOTOR	FRONTAL / IZQ / 302 / 351	<b>781</b>
		78 - 84	MOTOR	FRONTAL / IZQ / 302	<b>739</b>	
			MOTOR	FRONTAL / DER / 302	<b>740</b>	
TRANSMISIÓN			STD / 302	<b>810</b>		
L6	3.3	79 - 81	TRANSMISIÓN	AUT / STD	<b>790</b>	
		79 - 82	MOTOR	FRONTAL / DER / IZQ	<b>PRÓXIMAMENTE</b>	
V6	3.8	94 - 96	TRANSMISIÓN	AUT / STD	<b>A2707</b>	
		96 - 98	TRANSMISIÓN	STD / AUT	<b>790</b>	
		96 - 04	MOTOR	FRONTAL / IZQ	<b>PRÓXIMAMENTE</b>	
			MOTOR	FRONTAL / DER	<b>PRÓXIMAMENTE</b>	
V8	4.6	96 - 98	TRANSMISIÓN		<b>790</b>	
		96 - 04	MOTOR	FRONTAL / IZQ	<b>A2998</b>	
			MOTOR	FRONTAL / DER	<b>A2997</b>	
V8	5.0	94 - 95	MOTOR	FRONTAL / IZQ	<b>A2725</b>	
			MOTOR	FRONTAL / DER	<b>A2726</b>	

						
<b>513</b>	<b>514</b>	<b>515</b>	<b>598</b>	<b>599</b>	<b>739</b>	<b>740</b>
						
<b>781</b>	<b>790</b>	<b>810</b>	<b>5186</b>	<b>A2707</b>	<b>A2725</b>	<b>A2726</b>
						
<b>A2997</b>	<b>A2998</b>	<b>PRÓXIMAMENTE</b>	<b>PRÓXIMAMENTE</b>	<b>PRÓXIMAMENTE</b>		

PROBE	MOTOR	MODELO	SOPORTE	ESPECIFICACIÓN	No. BUFALO
L4	2.0	93 - 97	MOTOR	FRONTAL / STD	<b>A8073</b>
			MOTOR	TRASERO / STD / 5 VEL	PRÓXIMAMENTE
			TRANSMISIÓN	CENTRAL / INFERIOR / STD	PRÓXIMAMENTE
			TRANSMISIÓN	CENTRAL / INFERIOR / AUT	<b>A9087</b>
		94 - 97	TRANSMISIÓN	TRASERO	<b>A8691</b>

L4	2.2	89 - 92	MOTOR	FRONTAL / STD / 5 VEL	PRÓXIMAMENTE
			MOTOR	FRONTAL / DER / TURBO	<b>A8074</b>
			MOTOR	TRASERO / AUT	PRÓXIMAMENTE
			MOTOR	TRASERO / TURBO	<b>A8087</b>
			MOTOR	TRASERO / STD	PRÓXIMAMENTE
			TRANSMISIÓN	AUT	<b>A8516</b>

V6	2.5	93 - 97	MOTOR	FRONTAL	<b>A8073</b>
			MOTOR	TRASERO	PRÓXIMAMENTE
			TRANSMISIÓN	CENTRAL / INFERIOR / STD	PRÓXIMAMENTE
			TRANSMISIÓN	CENTRAL / INFERIOR / AUT	<b>A9087</b>

V6	3.0	90 - 92	MOTOR	FRONTAL	PRÓXIMAMENTE
			MOTOR	TRASERO	<b>A8087</b>

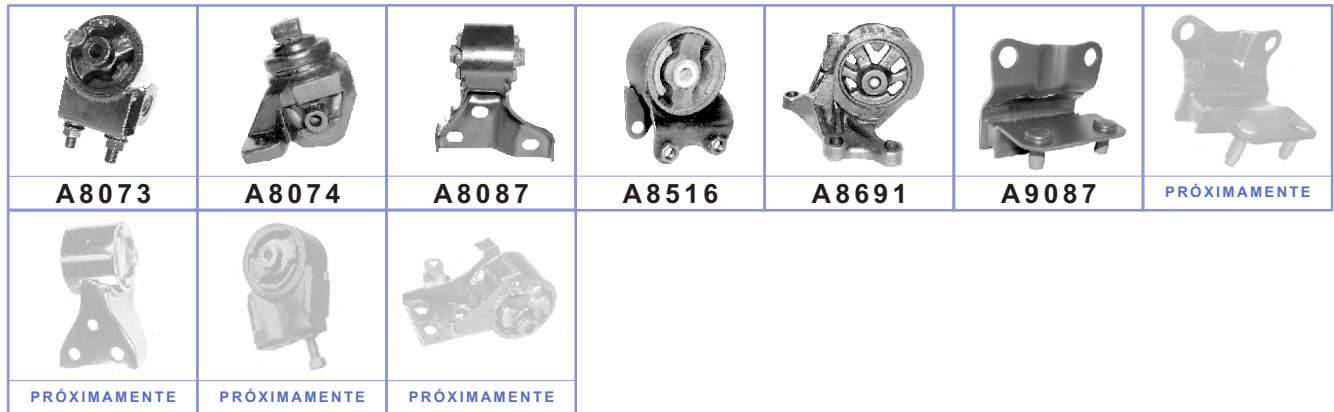

SABLE "MERCURY"	MOTOR	MODELO	SOPORTE	ESPECIFICACIÓN	No. BUFALO
V6	3.0	86 - 90	MOTOR	TRASERO / DER	<b>A2622</b>
		89 - 06	TRANSMISIÓN	SUPER CARGADO	<b>855</b>
		91 - 92	MOTOR	FRONTAL / DER	PRÓXIMAMENTE
		91 - 95	MOTOR	TRASERO / DER	PRÓXIMAMENTE
		93	MOTOR	FRONTAL / DER	PRÓXIMAMENTE
		94 - 95	MOTOR	FRONTAL / DER	<b>A2790HY</b>
		96 - 99	MOTOR	FRONTAL / DER	<b>A2789HY</b>
			MOTOR	TRASERO / DER	PRÓXIMAMENTE
		96 - 03	MOTOR	TRASERO / DER / DOBLE ÁRBOL / 24 VÁLVULAS	<b>A2862</b>
		00 - 03	MOTOR	TORSIÓN / TRASERO	PRÓXIMAMENTE
		00 - 06	MOTOR	FRONTAL / DER	<b>A2996</b>
			MOTOR	TRASERO / DER	<b>A5243</b>

CONTINÚA...



# F O R D

**AUTOS**

SABLE "MERCURY"	MOTOR	MODELO	SOPORTE	ESPECIFICACIÓN	No. BUFALO
	V6 3.0	04 - 06	MOTOR	TORSIÓN / TRASERO	PRÓXIMAMENTE
	V6 3.8	88 - 95	MOTOR	FRONTAL / DER	<b>860-B</b>
			MOTOR	TRASERO / DER	<b>1103</b>
			TRANSMISIÓN		<b>855</b>

<b>855</b>	<b>860-B</b>	<b>1103</b>	<b>A2622</b>	<b>A2789HY</b>	<b>A2790HY</b>	<b>A2862</b>
<b>A2996</b>	<b>A5243</b>	PRÓXIMAMENTE	PRÓXIMAMENTE	PRÓXIMAMENTE	PRÓXIMAMENTE	PRÓXIMAMENTE

TAURUS	MOTOR	MODELO	SOPORTE	ESPECIFICACIÓN	No. BUFALO
	L4	88 - 91	MOTOR	TRASERO / DER	<b>A2770</b>
	V6 3.0	86 - 90	MOTOR	TRASERO / DER	<b>A2622</b>
		89 - 06	TRANSMISIÓN	SUPER CARGADO	<b>855</b>
		91 - 92	MOTOR	FRONTAL / DER	PRÓXIMAMENTE
		91 - 95	MOTOR	TRASERO / DER	PRÓXIMAMENTE
		93	MOTOR	FRONTAL / DER	PRÓXIMAMENTE
		94 - 95	MOTOR	FRONTAL / DER	<b>A2790HY</b>
		96 - 99	MOTOR	FRONTAL / DER	<b>A2789HY</b>
			MOTOR	TRASERO / DER	PRÓXIMAMENTE
		96 - 03	MOTOR	TRASERO / DER / DOBLE ÁRBOL / 24 VÁLVULAS	<b>A2862</b>
		00 - 03	MOTOR	TORSIÓN / TRASERO	PRÓXIMAMENTE
		00 - 06	MOTOR	FRONTAL / DER	<b>A2996</b>
			MOTOR	TRASERO / DER	<b>A5243</b>
		04 - 06	MOTOR	TORSIÓN / TRASERO	PRÓXIMAMENTE
		V6 3.2	93 - 95	MOTOR	FRONTAL
	MOTOR			TRASERO	PRÓXIMAMENTE
	TRANSMISIÓN				<b>855</b>
	V6 3.4	96 - 99	MOTOR	FRONTAL	<b>A2789HY</b>
			MOTOR	TRASERO	<b>A2862</b>
			TRANSMISIÓN		<b>855</b>

CONTINUA...



# F O R D

**AUTOS**



TAURUS	MOTOR	MODELO	SOPORTE	ESPECIFICACIÓN	No. BUFALO
V6 3.8	86 - 90	MOTOR	FRONTAL / DER / AUT	<b>A 2623</b>	
			FRONTAL / DER	<b>860 - B</b>	
			TRASERO / DER	<b>1103</b>	
	88 - 95	MOTOR	FRONTAL / DER	<b>855</b>	
			TRASERO / DER	<b>860</b>	
			TRANSMISIÓN	<b>860 - A</b>	
V8	93 - 95	MOTOR	FRONTAL / DER	<b>A 2968HY</b>	
			TRASERO		

<b>855</b>	<b>860</b>	<b>860 - A</b>	<b>860 - B</b>	<b>1103</b>	<b>A 2622</b>	<b>A 2623</b>
<b>A 2770</b>	<b>A 2789HY</b>	<b>A 2790HY</b>	<b>A 2862</b>	<b>A 2968HY</b>	<b>A 2996</b>	<b>A 5243</b>
<b>PRÓXIMAMENTE</b>	<b>PRÓXIMAMENTE</b>	<b>PRÓXIMAMENTE</b>	<b>PRÓXIMAMENTE</b>	<b>PRÓXIMAMENTE</b>	<b>PRÓXIMAMENTE</b>	<b>PRÓXIMAMENTE</b>

TEMPO / TOPAZ	MOTOR	MODELO	SOPORTE	ESPECIFICACIÓN	No. BUFALO	
L4	2.0	74 - 88	MOTOR	TRASERO / SIN BASE	<b>800 - C</b>	
			84 - 85	TRANSMISIÓN	STD / 5 VEL	<b>938</b>
		84 - 91	MOTOR	FRONTAL / REPUESTO	<b>A 2559</b>	
				FRONTAL / DER	<b>792 - A</b>	
				FRONTAL / DER / CON BASE	<b>792</b>	
				TRASERO / CON BASE	<b>800</b>	
				AUT / HIDRÁULICO	<b>802</b>	
				FRONTAL / DER	<b>802 - B</b>	
		2.3	84 - 92	MOTOR	FRONTAL	<b>873</b>
				MOTOR	TRASERO / CON BASE	<b>897</b>
				MOTOR	TRASERO / SIN BASE	<b>897 - A</b>
		2.4	84 - 94	TRANSMISIÓN	STD / 5 VEL	<b>938</b>
					AUT	<b>823</b>
			86 - 91	MOTOR	FRONTAL / AUT	<b>823</b>
					DELANTERO / IZQ	<b>802</b>
			86 - 94	TRANSMISIÓN	AUT / STD / CON BASE / 5 VEL	<b>938 - A</b>
					FRONTAL / REPUESTO	<b>875</b>
			92 - 94	MOTOR	FRONTAL	<b>PRÓXIMAMENTE</b>
					FRONTAL / DER / REPUESTO	<b>876</b>
					MOTOR	FRONTAL / DER



# F O R D

**AUTOS**

TEMPO / TOPAZ	MOTOR	MODELO	SOPORTE	ESPECIFICACIÓN	No. BUFALO
	V6 3.0	92 - 94	MOTOR	FRONTAL / IZQ / REPUESTO	<b>875</b>
			MOTOR	FRONTAL / IZQ	<b>PRÓXIMAMENTE</b>
			TRANSMISIÓN	AUT	<b>823</b>
			TRANSMISIÓN	STD	<b>938</b>
			TRANSMISIÓN	STD / CON BASE	<b>938-A</b>

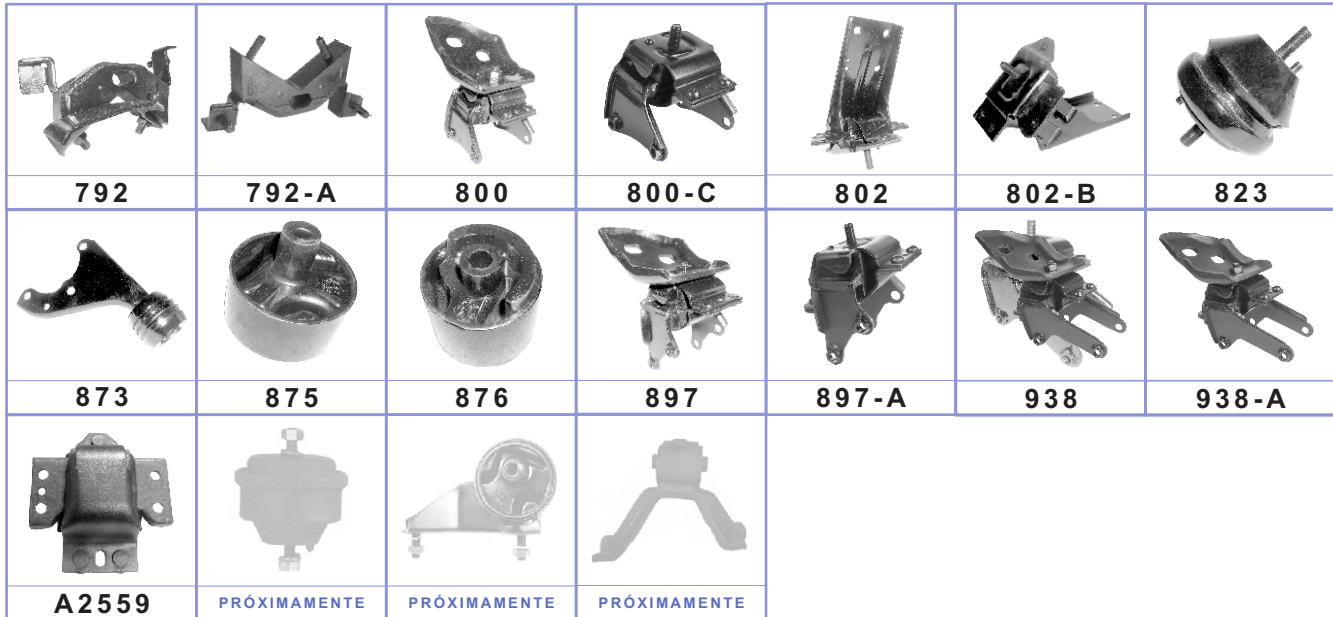

THUNDERBIRD	MOTOR	MODELO	SOPORTE	ESPECIFICACIÓN	No. BUFALO
	V8	54 - 82	MOTOR	FRONTAL / DER / IZQ	<b>240</b>
	V6 3.8	85 - 87	MOTOR	FRONTAL / IZQ	<b>904</b>
			MOTOR	FRONTAL / DER	<b>905</b>
	V8	77 - 99	MOTOR	FRONTAL / DER	<b>A2364</b>
			MOTOR	FRONTAL / IZQ	<b>A2365</b>
			MOTOR	FRONTAL / DER	<b>A2370</b>
			MOTOR	FRONTAL / IZQ	<b>A2371</b>
	V8	80 - 82	MOTOR	FRONTAL / IZQ	<b>A2500</b>
			MOTOR	FRONTAL / DER	<b>A2501</b>
			TRANSMISIÓN	AUT	<b>790</b>
		86 - 97	MOTOR	HIDRÁULICO	<b>A2995</b>
			MOTOR	FRONTAL / DER / IZQ	<b>855</b>
			MOTOR		<b>A2707</b>
	5.0	94 - 95	MOTOR	FRONTAL / IZQ	<b>A2725</b>
			MOTOR	FRONTAL / DER	<b>A2726</b>

CONTINÚA...

# F O R D

**AUTOS**



<b>THUNDERBIRD</b>						
<b>240</b>	<b>790</b>	<b>855</b>	<b>904</b>	<b>905</b>	<b>A2364</b>	
<b>A2365</b>	<b>A2370</b>	<b>A2371</b>	<b>A2500</b>	<b>A2501</b>	<b>A2707</b>	<b>A2725</b>
<b>A2726</b>	<b>A2995</b>					

<b>TORINO</b>	MOTOR	MODELO	SOPORTE	ESPECIFICACIÓN	No. <i>BUFALO</i>
	V8 5.0	72 - 74	MOTOR	FRONTAL / DER	<b>A2370</b>
	5.8		MOTOR	FRONTAL / IZQ	<b>A2371</b>

<b>A2370</b>	<b>A2371</b>

<b>TOWNCAR "LINCOLN"</b>	MOTOR	MODELO	SOPORTE	ESPECIFICACIÓN	No. <i>BUFALO</i>
	V8 4.6	91 - 97	MOTOR	FRONTAL / IZQ	<b>A2807</b>
			MOTOR	FRONTAL / DER	<b>A2806</b>
			TRANSMISIÓN		<b>928 - A</b>
	98 - 02	98 - 02	MOTOR	FRONTAL / IZQ	<b>A2861</b>
			MOTOR	FRONTAL / IZQ	<b>A2860</b>
03 - 07	03 - 07	TRANSMISIÓN		<b>PRÓXIMAMENTE</b>	

<b>928 - A</b>	<b>A2806</b>	<b>A2807</b>	<b>A2860</b>	<b>A2861</b>	<b>PRÓXIMAMENTE</b>



# F O R D

**AUTOS**

TRACER "MERCURY"	MOTOR	MODELO	SOPORTE	ESPECIFICACIÓN	No. BUFALO
L4	1.8	91 - 93	MOTOR	AUT / MOT. 1.8	964
			MOTOR	FRONTAL / REPUESTO 964	964 - R
	1.9	91 - 96	MOTOR	STD	964
			MOTOR	FRONTAL / DER / REPUESTO A2649	921
			MOTOR	FRONTAL / DER	A2649
			MOTOR	TRASERO / IZQ / REPUESTO A2650	920
			MOTOR	TRASERO / IZQ	A2650

TRACER "MERCURY"	MOTOR	MODELO	SOPORTE	ESPECIFICACIÓN	No. BUFALO
L4	1.8	91 - 96	TRANSMISIÓN	REPUESTO 963	963 - R
			TRANSMISIÓN	FRONTAL / AUT / MOT. 1.8	963
	1.9	94 - 96	MOTOR	REPUESTO 978	978 - R
			MOTOR		978

L4	2.0	97 - 03	MOTOR	FRONTAL / AUT / 4 VEL	978
			MOTOR	FRONTAL / REPUESTO 964	964 - R
			MOTOR	FRONTAL	964
			MOTOR	FRONTAL / DER / REPUESTO A2649	921
			MOTOR	FRONTAL / DER	A2649
			MOTOR	TRASERO / REPUESTO A2650	920
			MOTOR	TRASERO / AUT	A2650
			MOTOR	TRASERO / STD	A2912
			TRANSMISIÓN	AUT / STD	963 - A

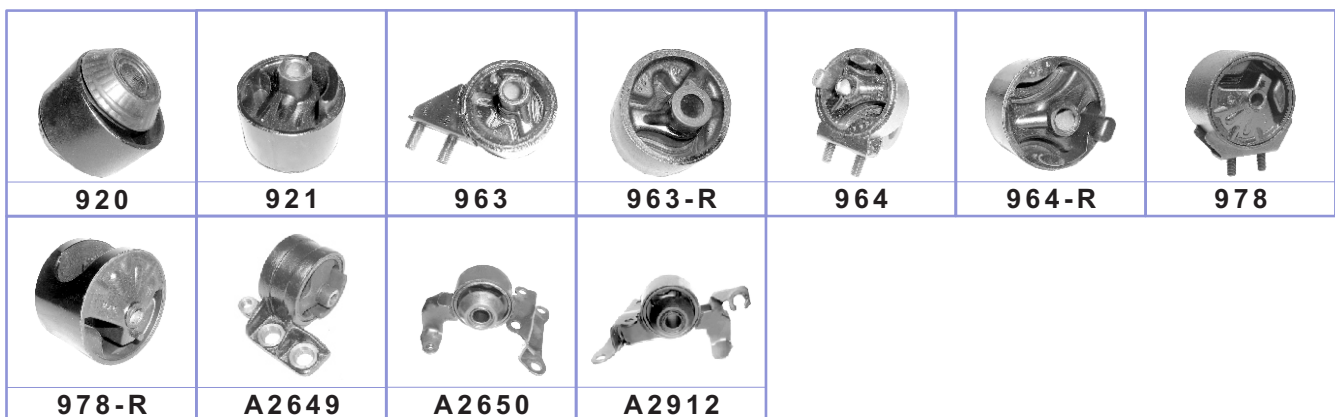

# CALIDAD Y GARANTÍA

# F O R D

**TODO TERRENO**



BRONCO		MOTOR	MODELO	SOPORTE	ESPECIFICACIÓN	No. BUFALO
L6	4.9	80 - 94	MOTOR		FRONTAL / IZQ	891
			MOTOR		FRONTAL / DER	891-A
		80 - 96	TRANSMISIÓN			769
		85 - 88	MOTOR		FRONTAL / DER	PRÓXIMAMENTE
			MOTOR		FRONTAL / IZQ	PRÓXIMAMENTE
		87 - 93	TRANSMISIÓN			880
89 - 93	MOTOR		FRONTAL / DER / IZQ	823-A		
V8	5.0	68 - 86	MOTOR		FRONTAL / DER / IZQ	762
			TRANSMISIÓN			769
		87 - 93	TRANSMISIÓN			880
		87 - 96	MOTOR		FRONTAL / DER / IZQ	839
TRANSMISIÓN				880-A		
V8	5.8	78 - 79	TRANSMISIÓN		STD	520
		78 - 82	MOTOR		FRONTAL / DER	909
			MOTOR		FRONTAL / IZQ	910
		80 - 86	TRANSMISIÓN			769
		83 - 86	MOTOR		FRONTAL / DER / IZQ	762
		87 - 93	TRANSMISIÓN			880
		89 - 96	MOTOR		FRONTAL / DER / IZQ	839
94 - 95	TRANSMISIÓN			880-A		
V8	6.6	78 - 79	MOTOR		FRONTAL / DER	909
			MOTOR		FRONTAL / IZQ	910
			TRANSMISIÓN		AUT / STD	520

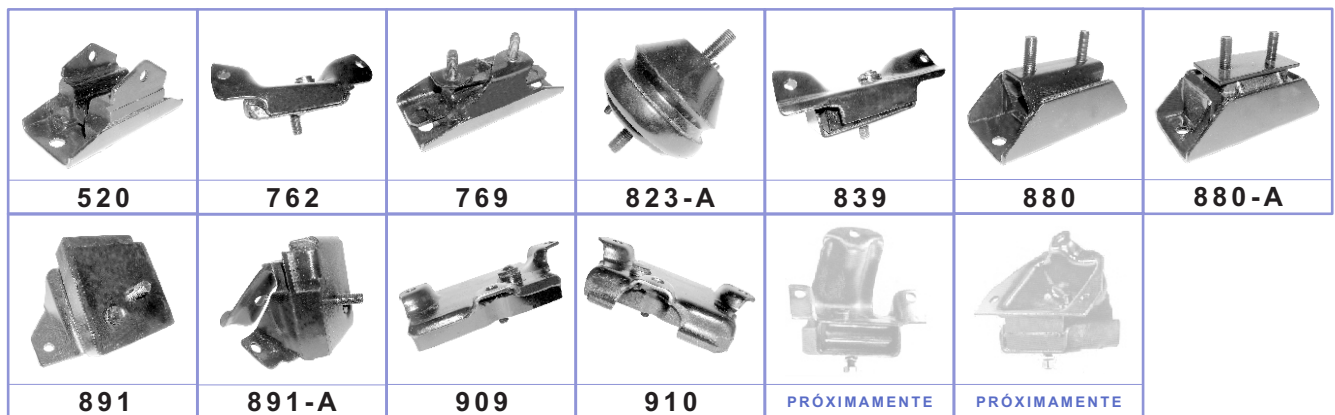

## DE EXPORTACIÓN

**Autopartes Hule - Metal**



# F O R D

**TODO TERRENO**

BRONCO II	MOTOR	MODELO	SOPORTE	ESPECIFICACIÓN	No. BUFALO
	V6 2.9	86 - 90	MOTOR	FRONTAL / IZQ / 4 X 4	<b>A2643</b>
			MOTOR	FRONTAL / IZQ / 2 X 2	<b>A2642</b>
			MOTOR	FRONTAL / DER	<b>A2641</b>
			MOTOR	FRONTAL / IZQ	<b>A2640</b>
			TRANSMISIÓN	AUT / STD	<b>941</b>



ECOSPORT	MOTOR	MODELO	SOPORTE	ESPECIFICACIÓN	No. BUFALO
	L4 2.0	03 - 11	MOTOR	FRONTAL / DER	<b>1062</b>
			MOTOR	TORSIÓN / TRASERO / AUT	<b>PRÓXIMAMENTE</b>
			MOTOR	TORSIÓN / TRASERO / STD	<b>1074</b>
			TRANSMISIÓN		<b>1073</b>

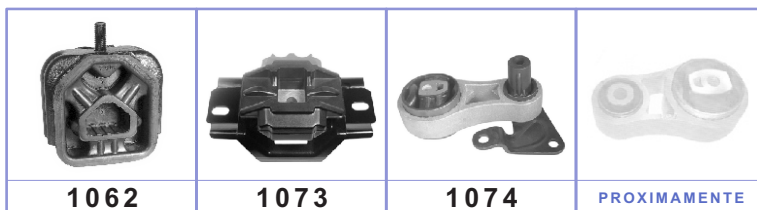

ESCAPE	MOTOR	MODELO	SOPORTE	ESPECIFICACIÓN	No. BUFALO
	L4 2.0	01 - 05	MOTOR	FRONTAL / DER / TRACCIÓN DELANTERA Y 4 X 4	<b>1096</b>
			TRANSMISIÓN	TRACCIÓN DELANTERA Y 4 X 4	<b>A3057</b>
			TRANSMISIÓN	AUT	<b>A3037</b>
	L4 2.3	06 - 11	MOTOR	FRONTAL / DER	<b>1127-A</b>
			MOTOR	FRONTAL / IZQ	<b>PRÓXIMAMENTE</b>
			MOTOR	TRASERO	<b>PRÓXIMAMENTE</b>
			TRANSMISIÓN		<b>PRÓXIMAMENTE</b>
	V6 3.0	00 - 11	MOTOR	FRONTAL / DER	<b>1096</b>
			MOTOR	FRONTAL / DER / IZQ / AUT / TRAC DELANTERA / 4X4	<b>A3057</b>
			TRANSMISIÓN	AUT / STD / TRACCIÓN DELANTERA / 4 X 4	<b>A3037</b>
			MOTOR	FRONTAL	<b>1127-A</b>

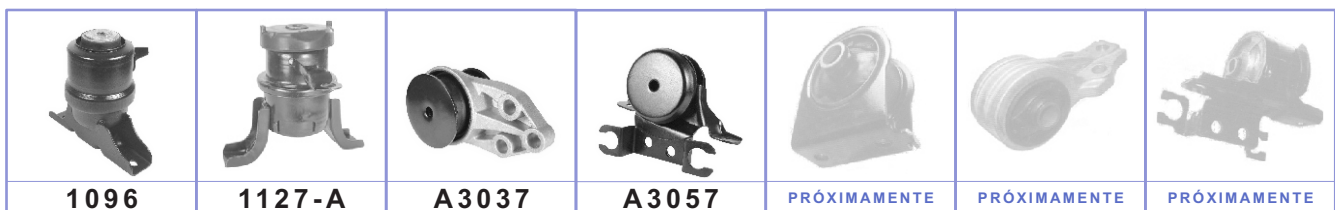

# F O R D

**TODOS LOS TERRENOS**



CONTINUA...

EXPEDITION	MOTOR	MODELO	SOPORTE	ESPECIFICACIÓN	No. BUFALO	
V8	4.6	97 - 02	MOTOR	FRONTAL / IZQ / TRACCIÓN TRASERA	A 2832	
			MOTOR	4 X 4	A 2972	
			MOTOR	FRONTAL / DER / TRACCIÓN TRASERA Y 4 X 4	A 2835	
			TRANSMISIÓN		880 - A	
		03 - 04	TRANSMISIÓN		A 9142	
			03 - 06	MOTOR	FRONTAL / IZQ	A 2929
				MOTOR	FRONTAL / DER	A 2930
		TRANSMISIÓN		4 X 4	A 9143	

V8	5.4	97 - 02	MOTOR	FRONTAL / DER	A 2835
			MOTOR	FRONTAL / IZQ / TRACCIÓN TRASERA	A 2832
		97 - 02	MOTOR	FRONTAL / IZQ / 4 X 4	A 2972
			TRANSMISIÓN	4 X 4	880 - A
		03 - 04	MOTOR	FRONTAL / DER	A 2835
			MOTOR	FRONTAL / IZQ	A 2929
		03 - 06	MOTOR	FRONTAL / DER	A 2930
			TRANSMISIÓN		A 9143

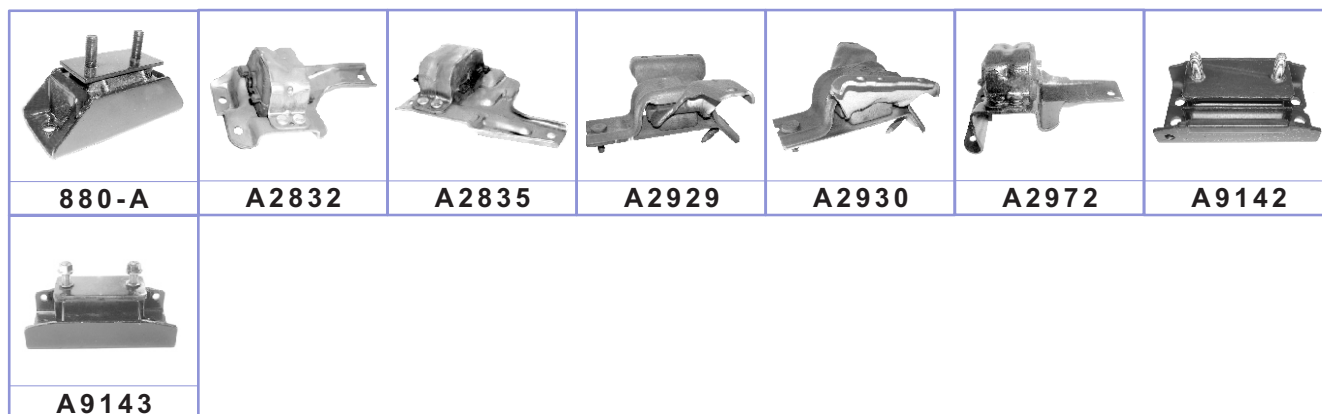

EXPLORER	MOTOR	MODELO	SOPORTE	ESPECIFICACIÓN	No. BUFALO
V6	4.0	91 - 94	MOTOR	FRONTAL / IZQ / TRACCIÓN TRASERA / 4 X 4 / SPORT	A 2643
			MOTOR	FRONTAL / IZQ / TRACCIÓN TRASERA / SPORT	A 2641
		91 - 05	TRANSMISIÓN		941
		95 - 96	MOTOR	FRONTAL / IZQ	PRÓXIMAMENTE
		95 - 01	MOTOR	FRONTAL / DER / TRACCIÓN TRASERA / 4 X 4	PRÓXIMAMENTE
		97 - 01	MOTOR	FRONTAL / IZQ	A 2851
		01 - 05	MOTOR	FRONTAL / IZQ / TRACCIÓN TRASERA / 4 X 4 / SPORT	A 2851
			MOTOR	FRONTAL / DER / TRACCIÓN TRASERA / 4 X 4 / SPORT	PRÓXIMAMENTE
			TRANSMISIÓN		A 2868

V6	4.0	02 - 06	MOTOR	FRONTAL / IZQ	PRÓXIMAMENTE
			MOTOR	FRONTAL / DER	PRÓXIMAMENTE
	4.6		TRANSMISIÓN	TRANSMISIÓN TRASERA	PRÓXIMAMENTE
			TRANSMISIÓN	4 X 4	PRÓXIMAMENTE

CONTINÚA...



MR

# F O R D

**TODO TERRENO**

EXPLORER	MOTOR	MODELO	SOORTE	ESPECIFICACIÓN	No. BUFALO
V8	5.0	96 - 01	MOTOR	FRONTAL / IZQ	PRÓXIMAMENTE
			MOTOR	FRONTAL / DER	PRÓXIMAMENTE
			TRANSMISIÓN	TRACCIÓN TRASERA	A 2868
			TRANSMISIÓN		A 2668

941	A2641	A2643	A2668	A2851	A2868	PRÓXIMAMENTE
PRÓXIMAMENTE	PRÓXIMAMENTE	PRÓXIMAMENTE	PRÓXIMAMENTE	PRÓXIMAMENTE	PRÓXIMAMENTE	PRÓXIMAMENTE

MARINER	MOTOR	MODELO	SOORTE	ESPECIFICACIÓN	No. BUFALO
V6	3.0	00 - 11	MOTOR	FRONTAL / DER	1096
			MOTOR	FRONTAL / DER / IZQ / AUT / TRAC DELANTERA / 4X4	A 3057
			TRANSMISIÓN	AUT / STD / TRACCIÓN DELANTERA / 4 X 4	A 3037

1096	A3037	A3057

MOUNTAINEER	MOTOR	MODELO	SOORTE	ESPECIFICACIÓN	No. BUFALO
V6	4.0	98 - 11	MOTOR	FRONTAL / IZQ	1096
			MOTOR	FRONTAL / DER	A 3057
			TRANSMISIÓN		A 3037

V6	4.0	91 - 94	MOTOR	FRONTAL / IZQ / TRACCIÓN TRASERA / 4 X 4 / SPORT	A 2643
			MOTOR	FRONTAL / IZQ / TRACCIÓN TRASERA / SPORT	A 2641
		91 - 05	TRANSMISIÓN		941
		95 - 96	MOTOR	FRONTAL / IZQ	PRÓXIMAMENTE
		95 - 01	MOTOR	FRONTAL / DER / TRACCIÓN TRASERA / 4 X 4	PRÓXIMAMENTE
		97 - 01	MOTOR	FRONTAL / IZQ	A 2851
		01 - 05	MOTOR	FRONTAL / IZQ / TRACCIÓN TRASERA / 4 X 4 / SPORT	A 2851
			MOTOR	FRONTAL / DER / TRACCIÓN TRASERA / 4 X 4 / SPORT	PRÓXIMAMENTE
	TRANSMISIÓN		A 2868		

CONTINÚA...



# F O R D

**TODO TERRENO**



MOUNTAINEER	MOTOR	MODELO	SOPORTE	ESPECIFICACIÓN	No. BUFALO
V6	4.0	02 - 06	MOTOR	FRONTAL / IZQ	PRÓXIMAMENTE
			MOTOR	FRONTAL / DER	PRÓXIMAMENTE
	4.6		TRANSMISIÓN	TRANSMISIÓN TRASERA	PRÓXIMAMENTE
			TRANSMISIÓN	4 X 4	PRÓXIMAMENTE
V8	5.0	96 - 01	MOTOR	FRONTAL / IZQ	PRÓXIMAMENTE
			MOTOR	FRONTAL / DER	PRÓXIMAMENTE
			TRANSMISIÓN	TRACCIÓN TRASERA	<b>A2868</b>

<b>941</b>	<b>1096</b>	<b>A2641</b>	<b>A2643</b>	<b>A2851</b>	<b>A2868</b>	<b>A3037</b>
<b>A3057</b>	PRÓXIMAMENTE	PRÓXIMAMENTE	PRÓXIMAMENTE	PRÓXIMAMENTE	PRÓXIMAMENTE	PRÓXIMAMENTE
PRÓXIMAMENTE	PRÓXIMAMENTE					

NAVIGATOR "LINCOLN"	MOTOR	MODELO	SOPORTE	ESPECIFICACIÓN	No. BUFALO
V8	5.0	98 - 02	MOTOR	FRONTAL / IZQ	<b>A2832</b>
			MOTOR	FRONTAL / DER	<b>A2835</b>
		98 - 03	MOTOR	FRONTAL / IZQ / 4 X 4	<b>A2972</b>
			TRANSMISIÓN	TRACCIÓN TRASERA / 4 X 4	PRÓXIMAMENTE

<b>A2832</b>	<b>A2835</b>	<b>A2972</b>	PRÓXIMAMENTE



MR

# F O R D

PICK UP

COURIER	MOTOR	MODELO	SOPORTE	ESPECIFICACIÓN	No. BUFALO
	L4 1.6	98 - 03	MOTOR	FRONTAL / DER	PRÓXIMAMENTE
			MOTOR	FRONTAL / DER / REPUESTO	1040
			MOTOR	FRONTAL / DER	PRÓXIMAMENTE
			MOTOR	TORSIÓN TRASERO	PRÓXIMAMENTE
			TRANSMISIÓN	REPUESTO 1024-C	1024
			TRANSMISIÓN		1024-C



F-100, F-150, F-250, F-350	MOTOR	MODELO	SOPORTE	ESPECIFICACIÓN	No. BUFALO	
	L6 V8 3.9	53 - 75	MOTOR	DELANTERO / INFERIOR	5042	
			MOTOR	TRASERO / INFERIOR	5192	
		60 - 62	MOTOR	FRONTAL / DER / IZQ	254	
			MOTOR	FRONTAL / IZQ	A2332	
		65 - 76	MOTOR	FRONTAL / DER	A2331	
			MOTOR		520	
			MOTOR	302 / 335 / 351 / 354	521	
		L6 4.9	65 - 73	MOTOR	FRONTAL / IZQ	A2332
				MOTOR	FRONTAL / DER	A2331
			65 - 76	TRANSMISIÓN	520	
74 - 84	MOTOR		FRONTAL / IZQ	891		
	MOTOR		FRONTAL / DER	891-A		
80 - 86	TRANSMISIÓN	769				
L6 4.9	85 - 96	MOTOR	FRONTAL / IZQ	PRÓXIMAMENTE		
		MOTOR	FRONTAL / DER	PRÓXIMAMENTE		
	87 - 93	TRANSMISIÓN	880			
	89 - 93	MOTOR	FRONTAL / DER / IZQ	823-A		
	94 - 96	TRANSMISIÓN	880-A			
V6 4.2	97 - 04	MOTOR	FRONTAL / IZQ	A2831		
		MOTOR	FRONTAL / DER	A2833		
		TRANSMISIÓN	880-A			
V8 4.6	83 - 92	MOTOR	FRONTAL / DER	A2727		
		MOTOR	FRONTAL / IZQ	A2728		
		MOTOR	FRONTAL / DER	A2834		
	97 - 98	MOTOR	FRONTAL / DER	PRÓXIMAMENTE		
		MOTOR	FRONTAL / IZQ / AUT / STD / 2 X 2	A2832		
	97 - 05	TRANSMISIÓN	FRONTAL / IZQ / 4 X 4	A2972		

CONTINÚA...

# F O R D

PICK UP



MR

F-100, F-150, F-250, F-350		MOTOR	MODELO	SOPORTE	ESPECIFICACIÓN	No. BUFALO
V6	4.6	83 - 92	MOTOR	FRONTAL / DER	<b>A 2727</b>	
			MOTOR	FRONTAL / IZQ	<b>A 2728</b>	
			MOTOR	FRONTAL / DER	<b>A 2834</b>	
V8	4.6	97 - 10	MOTOR	4 X 4	<b>A 9142</b>	
			MOTOR	TRACCIÓN TRASERA	<b>880 - A</b>	
		99 - 10	TRANSMISIÓN	FRONTAL / DER	<b>A 2835</b>	
		06 - 10	MOTOR	FRONTAL / IZQ	PRÓXIMAMENTE	
			MOTOR	FRONTAL / DER	PRÓXIMAMENTE	
V8	5.0	67 - 79	TRANSMISIÓN		<b>520</b>	
		69 - 93	MOTOR	FRONTAL / DER / IZQ	<b>762</b>	
		87 - 97	TRANSMISIÓN		<b>880</b>	
		87 - 99	MOTOR	FRONTAL / DER / IZQ	<b>839</b>	
		90 - 93	TRANSMISIÓN		<b>769</b>	
		92 - 99	TRANSMISIÓN		<b>880 - A</b>	
V8	5.4	97 - 98	MOTOR	FRONTAL / DER	PRÓXIMAMENTE	
		97 - 05	MOTOR	FRONTAL / IZQ / AUT / STD / 2 X 2	<b>A 2832</b>	
			MOTOR	FRONTAL / IZQ / 4 X 4	<b>A 2972</b>	
		97 - 10	TRANSMISIÓN	FRONTAL / DER / IZQ	<b>A 9143</b>	
			TRANSMISIÓN	4 X 4	<b>880 - A</b>	
		99 - 05	MOTOR	TRACCIÓN TRASERA	<b>A 2835</b>	
		05 - 10	MOTOR	FRONTAL / IZQ	PRÓXIMAMENTE	
			MOTOR	FRONTAL / DER	PRÓXIMAMENTE	
V8	5.8	66 - 67	MOTOR	FRONTAL / IZQ	<b>779</b>	
			MOTOR	FRONTAL / DER	<b>780</b>	
		66 - 79	TRANSMISIÓN		<b>520</b>	
		77 - 79	MOTOR	FRONTAL / IZQ	<b>910</b>	
			MOTOR	FRONTAL / DER	<b>909</b>	
		80 - 93	MOTOR	FRONTAL / DER / IZQ	<b>762</b>	
			TRANSMISIÓN		<b>769</b>	
		87 - 97	TRANSMISIÓN		<b>880</b>	
		92 - 99	MOTOR	FRONTAL / DER / IZQ	<b>839</b>	
			TRANSMISIÓN		<b>880 - A</b>	
		V8	5.9	68 - 76	MOTOR	FRONTAL / IZQ
MOTOR	FRONTAL / DER				<b>780</b>	
TRANSMISIÓN					<b>520</b>	
V8	6.8	99 - 10	TRANSMISIÓN	TRACCIÓN TRASERA	<b>880 - A</b>	
			TRANSMISIÓN	4 X 4	<b>A 9143</b>	
V8	6.9	83 - 86	TRANSMISIÓN		<b>769</b>	
			MOTOR	FRONTAL / IZQ	PRÓXIMAMENTE	
		87	TRANSMISIÓN		<b>880</b>	

CONTINÚA...



# F O R D

PICK UP

F-100, F-150, F-250, F-350	MOTOR	MODELO	SOPORTE	ESPECIFICACIÓN	No. BUFALO
V8 7.3		88 - 94	TRANSMISIÓN		<b>880</b>
		88 - 97	MOTOR	FRONTAL / IZQ	PRÓXIMAMENTE
			MOTOR	FRONTAL / DER	PRÓXIMAMENTE
		95 - 98	TRANSMISIÓN	TRANSMISIÓN TRASERA	<b>880</b>
		99 - 03	TRANSMISIÓN	4 X 4	<b>A9143</b>
TRANSMISIÓN	TRACCIÓN TRASERA		<b>880-A</b>		

V8 7.5	83 - 86	TRANSMISIÓN		<b>769</b>
	83 - 97	MOTOR	FRONTAL / DER / IZQ	PRÓXIMAMENTE
	87 - 93	TRANSMISIÓN		<b>880</b>
	94 - 97	TRANSMISIÓN		<b>880-A</b>

<b>254</b>	<b>520</b>	<b>521</b>	<b>762</b>	<b>769</b>	<b>779</b>	<b>780</b>
<b>823-A</b>	<b>839</b>	<b>880</b>	<b>880-A</b>	<b>891</b>	<b>891-A</b>	<b>909</b>
<b>910</b>	<b>5042</b>	<b>5192</b>	<b>A2331</b>	<b>A2332</b>	<b>A2727</b>	<b>A2728</b>
<b>A2831</b>	<b>A2832</b>	<b>A2833</b>	<b>A2834</b>	<b>A2835</b>	<b>A2972</b>	<b>A9142</b>
<b>A9143</b>	PRÓXIMAMENTE	PRÓXIMAMENTE	PRÓXIMAMENTE	PRÓXIMAMENTE	PRÓXIMAMENTE	PRÓXIMAMENTE
PRÓXIMAMENTE	PRÓXIMAMENTE					

# F O R D

PICK UP



F-600, F-700 F-800	MOTOR	MODELO	SOPORTE	ESPECIFICACIÓN	No. BUFALO
	V8	53 - 77	MOTOR	DELANTERO / INFERIOR	<b>5042</b>
			MOTOR	TRASERO / INFERIOR	<b>5192</b>
			MOTOR	SUPERIOR	<b>240-A</b>



LOBO	MOTOR	MODELO	SOPORTE	ESPECIFICACIÓN	No. BUFALO	
	V8	4.6	02 - 10		CARROCERIA	<b>A3911</b>
			05 - 10	MOTOR	FRONTAL / IZQ	PRÓXIMAMENTE
		MOTOR		FRONTAL / DER	PRÓXIMAMENTE	
		5.4		TRANSMISIÓN	TRACCIÓN TRASERA	<b>880-A</b>
		TRANSMISIÓN		4 X 4	<b>A9143</b>	

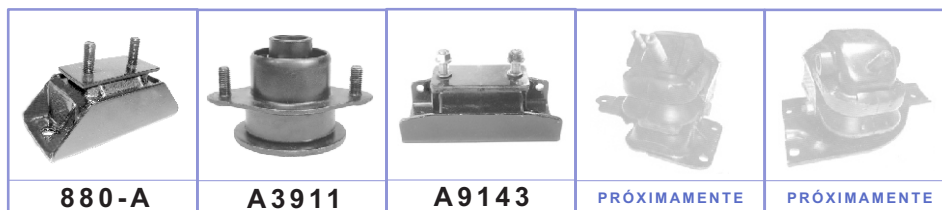

RANGER	MOTOR	MODELO	SOPORTE	ESPECIFICACIÓN	No. BUFALO		
	L4	2.0	85 - 87	MOTOR	FRONTAL / IZQ	<b>A2786</b>	
				MOTOR	FRONTAL / DER	<b>A2785</b>	
			TRANSMISIÓN	CABINA REGULAR	<b>941</b>		
			2.3	85 - 89	TRANSMISIÓN	AUT / STD	<b>A2631</b>
					TRANSMISIÓN		<b>941</b>
		85 - 97	TRANSMISIÓN		<b>941</b>		
			88 - 97	MOTOR	FRONTAL / DER / IZQ	<b>A2698</b>	
		L4	2.5	98 - 01	MOTOR	FRONTAL / DER / IZQ	<b>A2853</b>
					TRANSMISIÓN		<b>941</b>
		V6	2.9	83 - 85	MOTOR	FRONTAL / IZQ / 4WD	<b>A2940</b>
	MOTOR				FRONTAL / DER / 4WD	<b>A2941</b>	
	86 - 92			MOTOR	FRONTAL / IZQ / TRACCIÓN TRASERA	<b>A2642</b>	
				MOTOR	4 X 4	<b>A2643</b>	
				MOTOR	FRONTAL / DEL	<b>A2641</b>	
TRANSMISIÓN				TRACCIÓN TRASERA / 4 X 4	<b>941</b>		
98 - 03	MOTOR			FRONTAL / IZQ	<b>939</b>		
	MOTOR			FRONTAL / DER	<b>940</b>		

CONTINÚA...



# F O R D

PICK UP

RANGER	MOTOR	MODELO	SOPORTE	ESPECIFICACIÓN	No. BUFALO
V6	3.0	91 - 94	MOTOR	FRONTAL / IZQ / TRACCIÓN TRASERA	<b>A2642</b>
			MOTOR	FRONTAL / DER / TRACCIÓN TRASERA	<b>A2640</b>
			TRANSMISIÓN	TRACCIÓN TRASERA	<b>941</b>
		91 - 97	MOTOR	FRONTAL / IZQ / 4 X 4	<b>A2643</b>
			MOTOR	FRONTAL / DER / 4 X 4	<b>A2640</b>
		95 - 97	MOTOR	FRONTAL / DER / IZQ / TRACCIÓN TRASERA	<b>A2643</b>
		98 - 06	TRANSMISIÓN	TRACCIÓN TRASERA / 4 X 4	<b>941</b>
		98 - 01	MOTOR	FRONTAL / IZQ / 4 X 4	<b>A2851</b>
			MOTOR	FRONTAL / DER / 4 X 4	<b>PRÓXIMAMENTE</b>
		98 - 07	MOTOR	FRONTAL / DER / IZQ / TRACCIÓN TRASERA	<b>A2853</b>
V6	3.0	90	MOTOR	4 X 4	<b>941</b>
			MOTOR	FRONTAL / IZQ / 4 X 4	<b>A2643</b>
		90 - 97	TRANSMISIÓN	FRONTAL / IZQ / TRACCIÓN TRASERA	<b>A2642</b>
			MOTOR	FRONTAL / DER / 4 X 4 / TRACCIÓN TRASERA	<b>A2641</b>
		90 - 06	MOTOR	TRACCIÓN TRASERA / CABINA REGULAR	<b>941</b>
		98	MOTOR	4 X 4	<b>PRÓXIMAMENTE</b>
		98 - 06	TRANSMISIÓN	4 X 4	<b>941</b>
		98 - 07	MOTOR	FRONTAL / IZQ / 4 X 4	<b>A2851</b>
			MOTOR	FRONTAL / DER / TRACCIÓN TRASERA	<b>A2853</b>
		99 - 07	MOTOR	FRONTAL / DER / 4 X 4	<b>PRÓXIMAMENTE</b>

<b>939</b>	<b>940</b>	<b>941</b>	<b>A2631</b>	<b>A2640</b>	<b>A2641</b>	<b>A2642</b>
<b>A2643</b>	<b>A2698</b>	<b>A2785</b>	<b>A2786</b>	<b>A2851</b>	<b>A2853</b>	<b>A2940</b>
<b>A2941</b>	<b>PRÓXIMAMENTE</b>	<b>PRÓXIMAMENTE</b>	<b>PRÓXIMAMENTE</b>			

# CALIDAD Y GARANTÍA

# F O R D

PICK UP



RANGER "ARGENTINA"	MOTOR		MODELO	SOPORTE	ESPECIFICACIÓN	No. BUFALO
	L4	2.3	02 - 10	MOTOR	FRONTAL / DER / IZQ	PRÓXIMAMENTE
			TRANSMISIÓN		941	



941

PRÓXIMAMENTE

# F O R D

CAMIONETAS VAN

AEROSTAR	MOTOR		MODELO	SOPORTE	ESPECIFICACIÓN	No. BUFALO
	V6	3.0	86 - 97	MOTOR	FRONTAL / IZQ	A 2646
			MOTOR	FRONTAL / DER	A 2645	
			TRANSMISIÓN		941	
V6	4.0	90 - 97	MOTOR	FRONTAL / IZQ	A 2646	
			MOTOR	FRONTAL / DER	A 2644	
			TRANSMISIÓN		941	

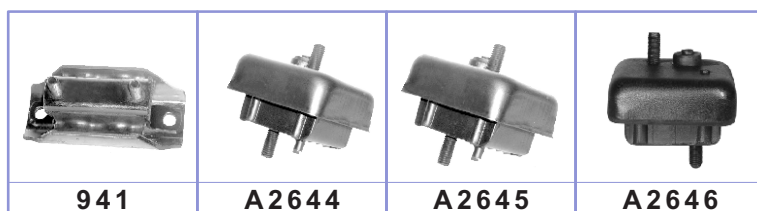

941

A 2644

A 2645

A 2646

ECOLINE CLUB WAGON E-100, E-150 E-250, E-300 E-350	MOTOR		MODELO	SOPORTE	ESPECIFICACIÓN	No. BUFALO
	L6	4.9	72 - 76	MOTOR	FRONTAL / IZQ	A 2332
MOTOR				FRONTAL / DER	A 2331	
TRANSMISIÓN					520	
77 - 84			MOTOR	FRONTAL / IZQ	891 - A	
			MOTOR	FRONTAL / DER	891	
85 - 96			MOTOR	FRONTAL / IZQ	PRÓXIMAMENTE	
			MOTOR	FRONTAL / DER	PRÓXIMAMENTE	
87 - 88			TRANSMISIÓN		769	
88 - 96			TRANSMISIÓN		880	
V8			4.6	97 - 06	MOTOR	FRONTAL / IZQ
	MOTOR	FRONTAL / DER			A 2929	
	TRANSMISIÓN				880	

CONTINÚA...



# F O R D

## GAMIONETAS VAN

ECOLINE CLUB WAGON E-100, E-150 E-250, E-300 E-350	MOTOR	MODELO	SOPORTE	ESPECIFICACIÓN	No. BUFALO	
	V8 5.0	68 - 74	MOTOR		FRONTAL / DER / IZQ	762
			TRANSMISIÓN			520
		75 - 91	MOTOR		FRONTAL / DER	A2439
			MOTOR		FRONTAL / IZQ	A2440
		83 - 00	TRANSMISIÓN			769
			MOTOR		FRONTAL / DER / <b>DIESEL</b>	A2767
	MOTOR		FRONTAL / IZQ / <b>DIESEL</b>	A2768		
	92 - 96	TRANSMISIÓN			880	

V8 5.4	97 - 06	MOTOR		FRONTAL / IZQ	A2930
		MOTOR		FRONTAL / DER	A2929
		TRANSMISIÓN			880
V8 5.8	75 - 91	TRANSMISIÓN		FRONTAL / IZQ	769
		MOTOR		FRONTAL / DER	A2930
	75 - 96	MOTOR			A2929
		TRANSMISIÓN			880

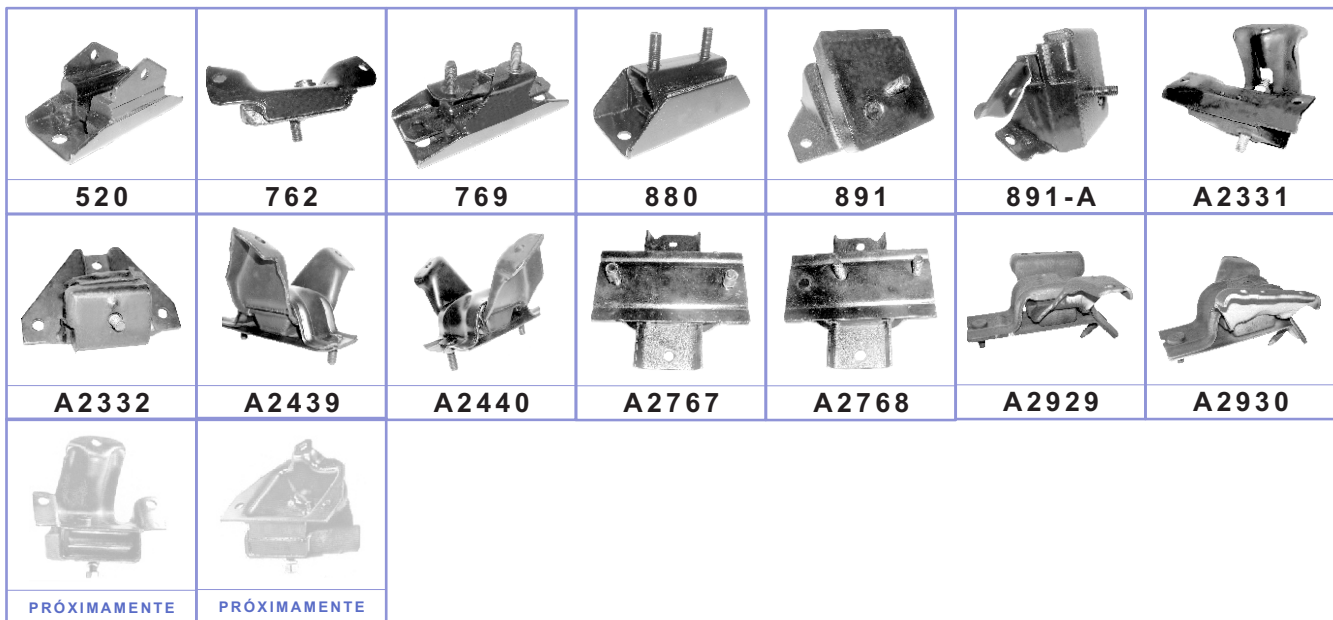

FREESTAR	MOTOR	MODELO	SOPORTE	ESPECIFICACIÓN	No. BUFALO
V6	3.9 4.2	04 - 07	MOTOR	FRONTAL / DER	PRÓXIMAMENTE
			MOTOR	TRASERO / DER	PRÓXIMAMENTE
			MOTOR	TORSIÓN / TRASERO	1130-A
			TRANSMISIÓN		PRÓXIMAMENTE

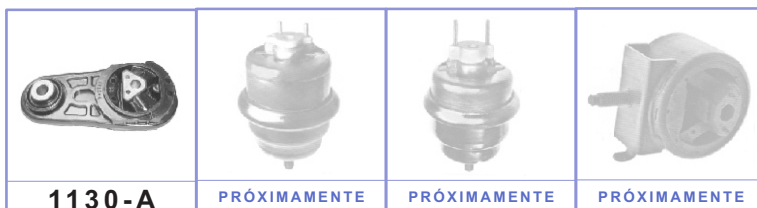



# F O R D

## CAMIONETAS VAN



MR

VILLAGER	MOTOR	MODELO	SOPORTE	ESPECIFICACIÓN	No. BUFALO
V6	3.0	93 - 98	MOTOR	FRONTAL / REPUESTO A2855	<b>835-B</b>
			MOTOR	FRONTAL	<b>A2855</b>
			MOTOR	TRASERO / IZQ	<b>A2856</b>
			MOTOR	TRASERO / IZQ / REPUESTO A2856	<b>1076</b>
			MOTOR	TRASERO / DER	<b>A2857</b>
			TRANSMISIÓN		<b>A2854</b>

V6	3.3	99 - 02	MOTOR	FRONTAL / REPUESTO A2989	<b>835-B</b>
			MOTOR	FRONTAL	<b>A2989</b>
			MOTOR	TRASERO / IZQ	<b>PRÓXIMAMENTE</b>
			MOTOR	TRASERO / DER	<b>A2857</b>
			TRANSMISIÓN		<b>A2854</b>

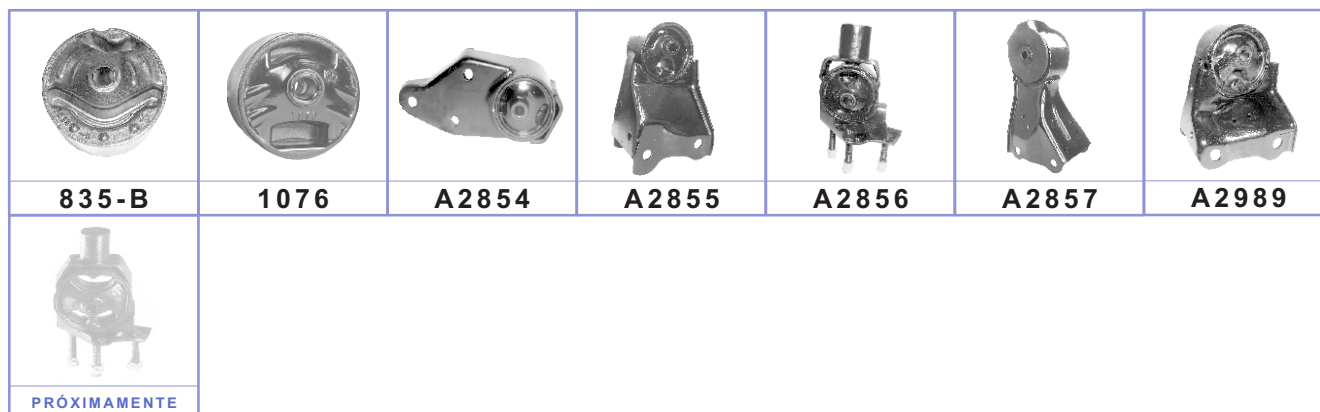

WINDSTAR	MOTOR	MODELO	SOPORTE	ESPECIFICACIÓN	No. BUFALO
V6	3.0	95 - 00	MOTOR	TRASERO / DER	<b>769</b>
			MOTOR	FRONTAL / DER	<b>A2931</b>
		99 - 00	MOTOR	FRONTAL / DER / CON BASE	<b>PRÓXIMAMENTE</b>
V6	3.8	95	MOTOR	FRONTAL / DER	<b>860-B</b>
			TRANSMISIÓN		<b>855</b>
		96 - 98	MOTOR	FRONTAL / DER	<b>PRÓXIMAMENTE</b>
			MOTOR	FRONTAL / DER	<b>A2915</b>
		99 - 04	TRANSMISIÓN		<b>A2977</b>
			MOTOR	FRONTAL / DER	<b>A2931</b>
			MOTOR	FRONTAL / DER / CON BASE	<b>PRÓXIMAMENTE</b>
			MOTOR	TRASERO / DER	<b>1103</b>
TRANSMISIÓN		<b>855</b>			





CONTINÚA...

### Autopartes Hule - Metal





**F O R D**

**CARGA PESADA**

<b>WINDSTAR</b>			
	PRÓXIMAMENTE	PRÓXIMAMENTE	PRÓXIMAMENTE

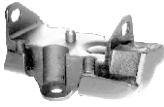
<b>CUSTOM 500</b>	MOTOR	MODELO	SOPORTE	ESPECIFICACIÓN	<b>No. BUFALO</b>
	V8 7.5	73 - 78	MOTOR	FRONTAL / DER	<b>A 2367</b>
			MOTOR	FRONTAL / IZQ	<b>A 2368</b>

	
<b>A2367</b>	<b>A2368</b>



**MR**

ACCORD		MOTOR	MODELO	SOPORTE	ESPECIFICACIÓN	No. <i>BUFALO</i>
L4	1.8	79 - 83	TRANSMISIÓN			PRÓXIMAMENTE
			MOTOR		TORSIÓN / TRASERO	<b>A8614-A</b>
		83 - 86	TRANSMISIÓN		AUT	PRÓXIMAMENTE
			MOTOR		TRASERO	<b>A8615</b>
L4	2.0	86 - 89	MOTOR		FRONTAL / IZQ	<b>A8019</b>
			MOTOR		FRONTAL	PRÓXIMAMENTE
			MOTOR		TRASERO	PRÓXIMAMENTE
			MOTOR		TORSIÓN / FRONTAL / TRASERO	<b>A8614-A</b>
L4	2.2	90 - 93	MOTOR		FRONTAL / IZQ	<b>A8016</b>
			MOTOR		TORSIÓN / FRONTAL	PRÓXIMAMENTE
			TRANSMISIÓN		AUT / STD	<b>A8347</b>
		90 - 95	MOTOR		TRASERO / STD / <b>DX / LX</b>	<b>993</b>
			MOTOR		TRASERO / AUT / SIN VÁLVULA SELENOIDE	<b>A8344</b>
		90 - 97	MOTOR		TRASERO / AUT	<b>A8009</b>
			MOTOR		TRASERO / CON VÁLVULA SELENOIDE	<b>A8984</b>
			TRANSMISIÓN		AUT	<b>A8347</b>
		94 - 97	MOTOR		FRONTAL / STD	<b>A8026</b>
			MOTOR		FRONTAL / AUT	<b>A8432</b>
			MOTOR		FRONTAL / IZQ	<b>A8074</b>
		96 - 97	TRANSMISIÓN		AUT	<b>A8347</b>
		L4	2.3	98 - 02	TRANSMISIÓN	
MOTOR					FRONTAL	<b>1104</b>
MOTOR					FRONTAL / IZQ	<b>A8899</b>
MOTOR					TRASERO	<b>A8845</b>
00 - 02	TRANSMISIÓN				AUT / 4 VEL	<b>A8983</b>
L4	2.4	03 - 07	MOTOR		FRONTAL	PRÓXIMAMENTE
			MOTOR		FRONTAL / DER / AUT	<b>1109</b>
			MOTOR		TRASERO / AUT	PRÓXIMAMENTE
			TRANSMISIÓN		TRASERO / AUT	PRÓXIMAMENTE
			TRANSMISIÓN		CENTRAL	PRÓXIMAMENTE
			TRANSMISIÓN		FRONTAL / IZQ / AUT	<b>1101</b>
		08 - 11	MOTOR		TRASERO	PRÓXIMAMENTE
			MOTOR		FRONTAL / DER	<b>1109</b>
			MOTOR		TRASERO	PRÓXIMAMENTE
			TRANSMISIÓN		FRONTAL	PRÓXIMAMENTE
			TRANSMISIÓN		SUPERIOR / REPUESTO	PRÓXIMAMENTE
TRANSMISIÓN		SUPERIOR	PRÓXIMAMENTE			
V6	3.0	98 - 02	MOTOR		FRONTAL	<b>1098</b>
			MOTOR		FRONTAL / DER / IZQ / REPUESTO A8974	<b>1094</b>
			MOTOR		FRONTAL / DER / IZQ	<b>A8974</b>
			MOTOR		TRASERO	<b>1099</b>
			TRANSMISIÓN		FRONTAL	<b>1100</b>

CONTINÚA...



# H O N D A

**AUTOS**

ACCORD	MOTOR	MODELO	SOPORTE	ESPECIFICACIÓN	No. BUFALO
V6 3.0	98 - 02	TRANSMISIÓN	TRASERO	1097	
			MOTOR	PRÓXIMAMENTE	
		00 - 02	MOTOR	1109	
	MOTOR		PRÓXIMAMENTE		
	MOTOR		1111		
	03 - 07	TRANSMISIÓN	PRÓXIMAMENTE		
		TRANSMISIÓN	PRÓXIMAMENTE		
		TRANSMISIÓN	1097		
	V6 3.5	08 - 11	MOTOR	1123-A	
MOTOR			1109		
MOTOR			1111		
TRANSMISIÓN			PRÓXIMAMENTE		
TRANSMISIÓN			PRÓXIMAMENTE		
TRANSMISIÓN			PRÓXIMAMENTE		

993	1094	1097	1098	1099	1100	1101
1104	1109	1111	1123-A	A8009	A8016	A8019
A8026	A8074	A8344	A8347	A8432	A8614-A	A8615
A8845	A8899	A8971	A8974	A8983	A8984	PRÓXIMAMENTE
PRÓXIMAMENTE	PRÓXIMAMENTE	PRÓXIMAMENTE	PRÓXIMAMENTE	PRÓXIMAMENTE	PRÓXIMAMENTE	PRÓXIMAMENTE

CONTINÚA...

<b>ACCORD</b>						
	PRÓXIMAMENTE	PRÓXIMAMENTE	PRÓXIMAMENTE	PRÓXIMAMENTE	PRÓXIMAMENTE	PRÓXIMAMENTE
PRÓXIMAMENTE	PRÓXIMAMENTE	PRÓXIMAMENTE	PRÓXIMAMENTE	PRÓXIMAMENTE		

<b>CIVIC</b>	MOTOR	MODELO	SOPORTE	ESPECIFICACIÓN	No. <i>BUFALO</i>
<b>L4</b>	1.3	<b>80 - 83</b>	MOTOR	FRONTAL / TRASERO	<b>A 8614 - A</b>
			TRANSMISIÓN	SUPERIOR	PRÓXIMAMENTE
		<b>03 - 05</b>	MOTOR	TRASERO / HIBRIDO EN MOT. 1.3	<b>A 9175</b>

<b>L4</b>	1.5	<b>80 - 83</b>	MOTOR	TORSIÓN / TRASERO	<b>A 8614 - A</b>
			TRANSMISIÓN		PRÓXIMAMENTE
		<b>88 - 91</b>	MOTOR	FRONTAL / AUT	<b>A 8411</b>
			MOTOR	FRONTAL / STD	PRÓXIMAMENTE
			MOTOR	TRASERO / AUT	PRÓXIMAMENTE
			TRANSMISIÓN		PRÓXIMAMENTE
		<b>92 - 93</b>	MOTOR	FRONTAL / SUP / IZQ / <b>VX</b>	PRÓXIMAMENTE
			TRANSMISIÓN	STD	PRÓXIMAMENTE
		<b>92 - 95</b>	MOTOR	FRONTAL	<b>973</b>
			MOTOR	FRONTAL / INF / IZQ / STD	<b>974</b>
			MOTOR	FRONTAL / INF / IZQ / AUT	<b>A 8411</b>
			MOTOR	FRONTAL / SUP / IZQ / <b>DH / LX</b>	PRÓXIMAMENTE
			MOTOR	FRONTAL / SUP / IZQ / <b>CX / DX / LX</b>	PRÓXIMAMENTE
			TRANSMISIÓN		<b>993</b>
		<b>94 - 95</b>	TRANSMISIÓN		PRÓXIMAMENTE

<b>L4</b>	1.6	<b>88 - 91</b>	MOTOR	FRONTAL	PRÓXIMAMENTE
			MOTOR	FRONTAL / AUT	<b>A 8411</b>
			MOTOR	FRONTAL / IZQ	<b>A 8020</b>
			MOTOR	TRASERO / AUT	<b>A 8007</b>
			TRANSMISIÓN	AUT	PRÓXIMAMENTE
		<b>92 - 93</b>	MOTOR	FRONTAL / SUP / IZQ / <b>EX / VX / DX</b>	PRÓXIMAMENTE
			TRANSMISIÓN	STD	PRÓXIMAMENTE
		<b>92 - 95</b>	MOTOR	FRONTAL / SUP / IZQ / <b>CX / Si / DX</b>	PRÓXIMAMENTE
			MOTOR	FRONTAL / DER	<b>973</b>
		<b>92 - 00</b>	MOTOR	FRONTAL	PRÓXIMAMENTE
			MOTOR	FRONTAL / INF / IZQ	PRÓXIMAMENTE
			TRANSMISIÓN	TRASERO	<b>973</b>



MR

# H O N D A

**AUTOS**

CIVIC	MOTOR	MODELO	SOPORTE	ESPECIFICACIÓN	No. BUFALO
L4	1.6	94 - 95	MOTOR	FRONTAL / SUP / IZQ / <i>EX SEDÁN / VX</i>	<b>974</b>
			TRANSMISIÓN		<b>993</b>
		96 - 00	MOTOR	TRASERO / SUP / IZQ	<b>979</b>
			TRANSMISIÓN	AUT	<b>994</b>
		99 - 00	MOTOR	FRONTAL / <i>Si</i>	PRÓXIMAMENTE
			MOTOR	FRONTAL / INF / IZQ / STD	PRÓXIMAMENTE

L4	1.7	01 - 05	MOTOR	FRONTAL / AUT	<b>1106</b>
			MOTOR	FRONTAL / STD	<b>A8975</b>
			MOTOR	TRASERO / STD	<b>A9175</b>
			TRANSMISIÓN	AUT / STD	PRÓXIMAMENTE
		02 - 05	MOTOR	FRONTAL / IZQ / <i>SOPORTE DE VACIO</i>	<b>A9016</b>

L4	1.8	06 - 10	MOTOR	FRONTAL / DER / <i>REPUESTO</i>	PRÓXIMAMENTE
			MOTOR	FRONTAL / DER	PRÓXIMAMENTE
			MOTOR	TORSIÓN / FRONTAL / SUPERIOR / STD	PRÓXIMAMENTE
			MOTOR	TORSIÓN / FRONTAL / SUPERIOR / AUT	PRÓXIMAMENTE
			MOTOR	TORSIÓN / TRASERO / INFERIOR / STD	PRÓXIMAMENTE
			MOTOR	TORSIÓN / TRASERO / INFERIOR / AUT	PRÓXIMAMENTE
			TRANSMISIÓN	AUT / STD	PRÓXIMAMENTE

<b>973</b>	<b>974</b>	<b>979</b>	<b>993</b>	<b>994</b>	<b>1106</b>	<b>A8007</b>
<b>A8020</b>	<b>A8411</b>	<b>A8614-A</b>	<b>A8975</b>	<b>A9016</b>	<b>A9175</b>	PRÓXIMAMENTE
PRÓXIMAMENTE	PRÓXIMAMENTE	PRÓXIMAMENTE	PRÓXIMAMENTE	PRÓXIMAMENTE	PRÓXIMAMENTE	PRÓXIMAMENTE
PRÓXIMAMENTE	PRÓXIMAMENTE	PRÓXIMAMENTE	PRÓXIMAMENTE	PRÓXIMAMENTE	PRÓXIMAMENTE	PRÓXIMAMENTE

CIVIC DEL SOL	MOTOR	MODELO	SOPORTE	ESPECIFICACIÓN	No. BUFALO
L4	1.5	93 - 95	MOTOR	FRONTAL	<b>973</b>
			MOTOR	FRONTAL / INF / IZQ	<b>974</b>
			MOTOR	FRONTAL / SUP / IZQ	PRÓXIMAMENTE
			MOTOR	TRASERO	<b>993</b>
			MOTOR	TRASERO / IZQ	PRÓXIMAMENTE
			TRANSMISIÓN	STD	PRÓXIMAMENTE
			TRANSMISIÓN	AUT	PRÓXIMAMENTE

L4	1.6	93	MOTOR	FRONTAL / SUP / IZQ	PRÓXIMAMENTE
			MOTOR	FRONTAL	<b>973</b>
			MOTOR	FRONTAL / INF / IZQ / AUT	<b>A8411</b>
		93 - 97	MOTOR	FRONTAL / INF / IZQ / STD	<b>974</b>
			MOTOR	FRONTAL / IZQ	PRÓXIMAMENTE
			MOTOR	TRASERO / STD	<b>993</b>
			TRANSMISIÓN	STD	PRÓXIMAMENTE
		94 - 97	MOTOR	FRONTAL / SUP / IZQ / <i>Si</i>	PRÓXIMAMENTE
			TRANSMISIÓN	AUT	PRÓXIMAMENTE



CIVIC <i>Si</i>	MOTOR	MODELO	SOPORTE	ESPECIFICACIÓN	No. BUFALO
L4	2.0	06 - 10	MOTOR	FRONTAL	PRÓXIMAMENTE



## CALIDAD Y GARANTÍA



# H O N D A

**AUTOS**

FIT	MOTOR	MODELO	SOPORTE	ESPECIFICACIÓN	No. BUFALO
L4	1.5	06 - 10	MOTOR	FRONTAL	PRÓXIMAMENTE
			MOTOR	FRONTAL / DER	PRÓXIMAMENTE
			MOTOR	TRASERO	PRÓXIMAMENTE
			TRANSMISIÓN	STD	PRÓXIMAMENTE
			TRANSMISIÓN	AUT	PRÓXIMAMENTE



PRELUDE	MOTOR	MODELO	SOPORTE	ESPECIFICACIÓN	No. BUFALO
L4	1.8	79 - 87	MOTOR	TRASERO / STD	PRÓXIMAMENTE
			MOTOR	TORSIÓN / FRONTAL / TRASERO	<b>A 8614-A</b>
		83 - 87	TRANSMISIÓN		PRÓXIMAMENTE

L4	2.0	85 - 87	MOTOR	FRONTAL / DER	PRÓXIMAMENTE
			MOTOR	TRASERO	PRÓXIMAMENTE
		85 - 88	MOTOR	TORSIÓN / FRONTAL	<b>A 8614-A</b>
		88	MOTOR	TRASERO / AUT	<b>993</b>
		88 - 91	MOTOR	FRONTAL / DER	PRÓXIMAMENTE
			MOTOR	TRASERO / STD	PRÓXIMAMENTE
			TRANSMISIÓN	AUT	PRÓXIMAMENTE

L4	2.2	92 - 96	MOTOR	TRASERO	<b>993</b>
			TRANSMISIÓN	MOD. 92 - 92 MOT. 2.2 / MOD. 92 - 94 MOT. 2.3	<b>A 8347</b>
	2.3	95 - 96	TRANSMISIÓN	SOLO APLICA MOT. 2.3	PRÓXIMAMENTE





CR-V	MOTOR	MODELO	SOPORTE	ESPECIFICACIÓN	No. BUFALO
L4	2.0	97 - 01	MOTOR	FRONTAL	<b>974</b>
			MOTOR	FRONTAL / IZQ / STD	<b>979</b>
			MOTOR	FRONTAL / DER	<b>973</b>
			MOTOR	TRASERO	<b>993</b>
			MOTOR	AUT / IZQ	<b>A8982</b>
			TRANSMISIÓN		<b>A8983</b>

L4	2.4	02 - 06	MOTOR	FRONTAL	<b>A9066</b>
			MOTOR	FRONTAL / DER	<b>A9139</b>
			MOTOR	TRASERO	<b>A8973</b>
			TRANSMISIÓN		<b>A9168</b>
			TRANSMISIÓN		PRÓXIMAMENTE
			DIFERENCIAL	TODOS LOS 4 X 4 EXCEPTO LX	PRÓXIMAMENTE

V6	3.5	07 - 10	MOTOR	FRONTAL	PRÓXIMAMENTE
			MOTOR	TORSIÓN / FRONTAL / DER	PRÓXIMAMENTE
			MOTOR	TORSIÓN / TRASERO / INF	PRÓXIMAMENTE
			TRANSMISIÓN		PRÓXIMAMENTE
			DIFERENCIAL	TODOS LOS 4 X 4 EXCEPTO LX	PRÓXIMAMENTE

<b>973</b>	<b>974</b>	<b>979</b>	<b>993</b>	<b>A8973</b>	<b>A8982</b>	<b>A8983</b>
<b>A9066</b>	<b>A9139</b>	<b>A9168</b>	PRÓXIMAMENTE	PRÓXIMAMENTE	PRÓXIMAMENTE	PRÓXIMAMENTE
PRÓXIMAMENTE	PRÓXIMAMENTE					

ELEMENT	MOTOR	MODELO	SOPORTE	ESPECIFICACIÓN	No. BUFALO
L4	2.4	03 - 07	MOTOR	FRONTAL	<b>A9066</b>
			MOTOR	TRASERO	<b>A8973</b>



# H O N D A

**TODO TERRENO**

ELEMENT	
	
<b>A8973</b>	<b>A9066</b>

PASSPORT	MOTOR	MODELO	SOPORTE	ESPECIFICACIÓN	No. BUFALO
L4	2.6	94 - 95	MOTOR	FRONTAL / IZQ	<b>A9144</b>
			MOTOR	FRONTAL / DER	PRÓXIMAMENTE
		94 - 96	TRANSMISIÓN		PRÓXIMAMENTE
			MOTOR	FRONTAL / IZQ	PRÓXIMAMENTE
		96	MOTOR	FRONTAL / DER	PRÓXIMAMENTE
			MOTOR		
L4	3.2	94 - 97	TRANSMISIÓN	AUT / 4 X 4	<b>A9142</b>
			TRANSMISIÓN	TRASERO / AUT / STD / 4 VEL	PRÓXIMAMENTE
		94 - 95	MOTOR	FRONTAL / DER / 2WD / 4WD	<b>A9144</b>
			MOTOR	FRONTAL / IZQ	PRÓXIMAMENTE
		96 - 01	MOTOR	FRONTAL / DER	PRÓXIMAMENTE
			MOTOR		

						
<b>A9142</b>	<b>A9144</b>	PRÓXIMAMENTE	PRÓXIMAMENTE	PRÓXIMAMENTE	PRÓXIMAMENTE	PRÓXIMAMENTE

PILOT	MOTOR	MODELO	SOPORTE	ESPECIFICACIÓN	No. BUFALO
V6	3.5	03 - 04	MOTOR	FRONTAL / DER	<b>A8974</b>
			MOTOR	TRASERO	PRÓXIMAMENTE
		03 - 05	TRANSMISIÓN	FRONTAL	<b>1100</b>
			TRANSMISIÓN	TRASERO	<b>1097</b>
		03 - 08	MOTOR	FRONTAL	PRÓXIMAMENTE
			MOTOR	TRASERO / 4 X 4	PRÓXIMAMENTE
		06 - 08	TRANSMISIÓN	FRONTAL / 4 X 4	PRÓXIMAMENTE
			TRANSMISIÓN	TRASERO / 4 X 4	PRÓXIMAMENTE

						
<b>1097</b>	<b>1100</b>	<b>A8974</b>	PRÓXIMAMENTE	PRÓXIMAMENTE	PRÓXIMAMENTE	PRÓXIMAMENTE

# H O N D A

**CAMIONETAS VAN**



ODYSSEY	MOTOR	MODELO	SOPORTE	ESPECIFICACIÓN	No. BUFALO
L4	2.2	95 - 98	MOTOR	FRONTAL	<b>A8432</b>
			MOTOR	FRONTAL / IZQ	<b>A8074</b>
	2.3		MOTOR	TRASERO / CON VÁLVULA SELENOIDAL	<b>A8984</b>
			MOTOR	TRASERO / SIN VÁLVULA SELENOIDAL	PRÓXIMAMENTE
	TRANSMISIÓN			<b>A8347</b>	

V6	3.5	94 - 04	MOTOR	FRONTAL	PRÓXIMAMENTE
			MOTOR	FRONTAL / DER	<b>A8974</b>
			MOTOR	TRASERO	PRÓXIMAMENTE
			TRANSMISIÓN	FRONTAL / AUT / 5 VEL	<b>1100</b>
			TRANSMISIÓN	TRASERO	<b>1097</b>
	05 - 10	MOTOR	FRONTAL	<b>1123-A</b>	
		MOTOR	FRONTAL / DER	PRÓXIMAMENTE	
		MOTOR	TRASERO	PRÓXIMAMENTE	
		TRANSMISIÓN	FRONTAL	PRÓXIMAMENTE	
		TRANSMISIÓN	TRASERO	PRÓXIMAMENTE	

<b>1097</b>	<b>1100</b>	<b>1123-A</b>	<b>A8074</b>	<b>A8347</b>	<b>A8432</b>	<b>A8974</b>
<b>A8984</b>	PRÓXIMAMENTE	PRÓXIMAMENTE	PRÓXIMAMENTE	PRÓXIMAMENTE	PRÓXIMAMENTE	PRÓXIMAMENTE
PRÓXIMAMENTE						

## CALIDAD Y GARANTÍA DE EXPORTACIÓN



# H U M M E R

**TODO TERRENO**

H2, H3	MOTOR	MODELO	SOPORTE	ESPECIFICACIÓN	No. BUFALO
	V8 6.0	03 - 08	MOTOR	FRONTAL / DER / IZQ	1057
			TRANSMISIÓN		A2638

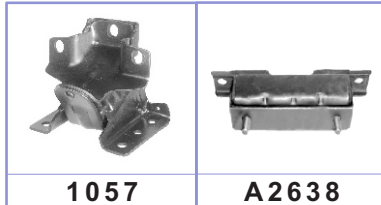

# H Y U N D A I

**AUTOS**

ACCENT	MOTOR	MODELO	SOPORTE	ESPECIFICACIÓN	No. BUFALO
L4 1.5		00 - 03	MOTOR	FRONTAL / AUT 4 VEL / STD 5 VEL	PRÓXIMAMENTE
			MOTOR	TRASERO	PRÓXIMAMENTE
			TRANSMISIÓN	STD / 5 VEL	PRÓXIMAMENTE
L4 1.6		00 - 02	MOTOR	FRONTAL / AUT 4 VEL / STD 5 VEL	PRÓXIMAMENTE
			MOTOR	TRASERO	PRÓXIMAMENTE
		00 - 03	MOTOR	FRONTAL / AUT 4 VEL / STD 5 VEL	PRÓXIMAMENTE
			TRANSMISIÓN	STD / 5 VEL	PRÓXIMAMENTE
		03 - 05	MOTOR	FRONTAL / STD	PRÓXIMAMENTE
		00 - 03	MOTOR	FRONTAL	PRÓXIMAMENTE
			MOTOR	FRONTAL / DER	PRÓXIMAMENTE
			MOTOR	TRASERO	PRÓXIMAMENTE
			TRANSMISIÓN		PRÓXIMAMENTE



EXCEL SCOUPE	MOTOR	MODELO	SOPORTE	ESPECIFICACIÓN	No. BUFALO
	L4 1.5	86 - 89	MOTOR	TORSIÓN / FRONTAL	PRÓXIMAMENTE
			MOTOR	TORSIÓN / FRONTAL	PRÓXIMAMENTE
		90 - 94	MOTOR	FRONTAL	A9160

CONTINÚA...

<b>EXCEL SCOUPE</b>			
	<b>A9160</b>	PRÓXIMAMENTE	PRÓXIMAMENTE

SONATA	MOTOR	MODELO	SOPORTE	ESPECIFICACIÓN	No. <i>BUFALO</i>
<b>L4</b>	1.5	<b>92 - 94</b>	MOTOR	FRONTAL / AUT	PRÓXIMAMENTE
		<b>95 - 96</b>	MOTOR	FRONTAL / AUT	PRÓXIMAMENTE
		<b>95 - 98</b>	MOTOR	TRASERO	PRÓXIMAMENTE
<b>L4</b>	2.0	<b>92 - 94</b>	MOTOR	FRONTAL / AUT	PRÓXIMAMENTE
		<b>95 - 96</b>	MOTOR	FRONTAL / AUT	PRÓXIMAMENTE
		<b>95 - 98</b>	MOTOR	TRASERO / AUT	PRÓXIMAMENTE
<b>L4</b>	2.4	<b>89 - 91</b>	MOTOR	FRONTAL / AUT	PRÓXIMAMENTE
<b>V6</b>	3.0	<b>90 - 94</b>	MOTOR	TRASERO	PRÓXIMAMENTE

PRÓXIMAMENTE	PRÓXIMAMENTE	PRÓXIMAMENTE	PRÓXIMAMENTE	PRÓXIMAMENTE

G 20	MOTOR	MODELO	SOPORTE	ESPECIFICACIÓN	No. <i>BUFALO</i>
<b>L4</b>	2.0	<b>91 - 96</b>	MOTOR	TRASERO	<b>1045-B</b>
			MOTOR	TRASERO	<b>1045-B</b>
		<b>99 - 02</b>	TRANSMISIÓN	<i>REPUESTO</i>	<b>1072</b>
			TRANSMISIÓN		PRÓXIMAMENTE

<b>1045-B</b>	<b>1072</b>	PRÓXIMAMENTE



# I N F I N I T I

AUTOS

I 30	MOTOR	MODELO	SOPORTE	ESPECIFICACIÓN	No. BUFALO
V6 3.0		96	MOTOR	FRONTAL / STD	<b>A8865</b>
			MOTOR	FRONTAL / DER / REPUESTO	<b>1072</b>
		96 - 99	MOTOR	FRONTAL / DER	<b>A9031</b>
			TRANSMISIÓN	STD / DER	<b>A9035</b>
		96 - 01	MOTOR	TRASERO / AUT 4 VEL / STD 5 VEL	<b>A8866</b>
			TRANSMISIÓN	REPUESTO	<b>1072</b>
			TRANSMISIÓN	AUT	PRÓXIMAMENTE
		00 - 01	MOTOR	FRONTAL / DER	PRÓXIMAMENTE
			TRANSMISIÓN	STD	PRÓXIMAMENTE



I 35	MOTOR	MODELO	SOPORTE	ESPECIFICACIÓN	No. BUFALO
V6 3.5	02 - 04	MOTOR	FRONTAL / DER	PRÓXIMAMENTE	
		TRANSMISIÓN	PRÓXIMAMENTE		

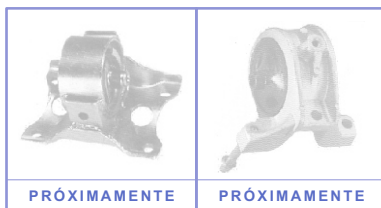

# I N F I N I T I

TODO TERRENO

QX 4	MOTOR	MODELO	SOPORTE	ESPECIFICACIÓN	No. BUFALO
V6 3.3	97 - 00	MOTOR	FRONTAL / DER / IZQ	<b>A8311</b>	
		TRANSMISIÓN	<b>A9038</b>		
V6 3.5	01 - 03	MOTOR	FRONTAL / DER / IZQ	<b>A8311</b>	
		TRANSMISIÓN	2 X 2	<b>A9038</b>	
		TRANSMISIÓN	4 X 4	<b>999</b>	



# I N F I N I T I

**TODO TERRENO**



QX 5	MOTOR	MODELO	SOPORTE	ESPECIFICACIÓN	No. BUFALO
V8 5.6	01 - 03	MOTOR	MOTOR	FRONTAL / DER / IZQ	PRÓXIMAMENTE
		TRANSMISIÓN	TRANSMISIÓN	2 X 2	PRÓXIMAMENTE
		TRANSMISIÓN	TRANSMISIÓN	4 X 4	PRÓXIMAMENTE



# I S U Z U

**TODO TERRENO**

AMIGO	MOTOR	MODELO	SOPORTE	ESPECIFICACIÓN	No. BUFALO
L4	2.3	87 - 93	MOTOR	IZQ	<b>A 8051</b>
		89 - 91	TRANSMISIÓN	TRACCIÓN TRASERA / AUT	<b>A 8870</b>
	2.6	89 - 94	MOTOR	FRONTAL / IZQ / 4 X 4 / TRACCIÓN TRASERA	PRÓXIMAMENTE
			MOTOR	FRONTAL / DER / 4 X 4 / TRACCIÓN TRASERA	PRÓXIMAMENTE
			TRANSMISIÓN	STD / TRACCIÓN TRASERA	<b>A 8870</b>
	92 - 94	TRANSMISIÓN	AUT / TRACCIÓN TRASERA	<b>A 9143</b>	

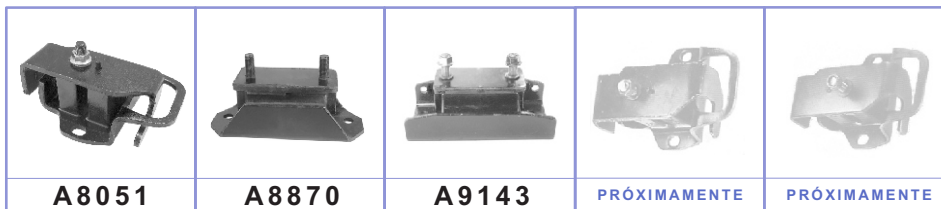



RODEO	MOTOR	MODELO	SOPORTE	ESPECIFICACIÓN	No. BUFALO
L4	2.6	91 - 97	TRANSMISIÓN		<b>A 9143</b>
		95 - 97	MOTOR	FRONTAL / IZQ	PRÓXIMAMENTE
			MOTOR	FRONTAL / DER	PRÓXIMAMENTE
V6	3.1	91 - 92	TRANSMISIÓN	TRACCIÓN TRASERA	<b>A 9143</b>
V6	3.2	93 - 97	TRANSMISIÓN	AUT / 4 X 4	<b>A 9142</b>
			TRANSMISIÓN	AUT / TRACCIÓN TRASERA	<b>A 9143</b>
			TRANSMISIÓN	STD / TRACCIÓN TRASERA	<b>A 8870</b>
		95 - 97	MOTOR	FRONTAL / IZQ / 4 X 4 / TRACCIÓN TRASERA	PRÓXIMAMENTE
			MOTOR	FRONTAL / DER	PRÓXIMAMENTE

CONTINÚA...

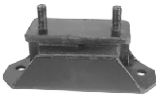
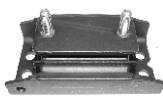
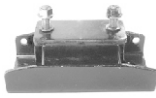
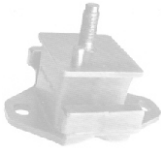

# I S U Z U

**TODO TERRENO**

<b>RODEO</b>						
	<b>A8870</b>	<b>A9142</b>	<b>A9143</b>	PRÓXIMAMENTE	PRÓXIMAMENTE	PRÓXIMAMENTE

TROOPER 4 X 4		MOTOR	MODELO	SOPORTE	ESPECIFICACIÓN	No. BUFALO
L4	1.9		81 - 87	MOTOR	FRONTAL / IZQ / 2WD / 4WD	<b>A8049</b>
			84 - 85	MOTOR	FRONTAL / IZQ	PRÓXIMAMENTE
				TRANSMISIÓN		<b>A9143</b>
87 - 95	MOTOR	FRONTAL / IZQ / 2WD / 4WD	<b>A8053</b>			
L4	2.2		84 - 85	MOTOR	FRONTAL / IZQ	PRÓXIMAMENTE
			87	TRANSMISIÓN	FRONTAL / IZQ	PRÓXIMAMENTE
				MOTOR	FRONTAL / DER / 4WD / TURBO / DIESEL	<b>A8052</b>
L4	2.3		81 - 87	MOTOR	FRONTAL / DER	<b>A8054</b>
			84 - 85	MOTOR	FRONTAL / IZQ	PRÓXIMAMENTE
			87	MOTOR	FRONTAL / IZQ	PRÓXIMAMENTE
				MOTOR	FRONTAL / DER	PRÓXIMAMENTE
				TRANSMISIÓN	STD / 5 VEL	<b>A9143</b>
L4	2.6	88 - 91	TRANSMISIÓN	FRONTAL / IZQ	<b>A9143</b>	
V6	2.8		MOTOR	FRONTAL / DER	PRÓXIMAMENTE	
			MOTOR	STD / 5 VEL / MOT. 2.6	PRÓXIMAMENTE	
V6	3.2		92 - 97	MOTOR		<b>A9142</b>
			96 - 97	MOTOR	FRONTAL / IZQ	PRÓXIMAMENTE
				MOTOR	FRONTAL / DER	PRÓXIMAMENTE
V6	3.5	88 - 91	MOTOR	FRONTAL / IZQ	PRÓXIMAMENTE	
			MOTOR	FRONTAL / DER	PRÓXIMAMENTE	
			TRANSMISIÓN		<b>A9142</b>	

						
<b>A8049</b>	<b>A8052</b>	<b>A8053</b>	<b>A8054</b>	<b>A9142</b>	<b>A9143</b>	PRÓXIMAMENTE
						
PRÓXIMAMENTE	PRÓXIMAMENTE	PRÓXIMAMENTE	PRÓXIMAMENTE	PRÓXIMAMENTE		



# I S U Z U

**TODO TERRENO**



VEHICROSS	MOTOR	MODELO	SOPORTE	ESPECIFICACIÓN	No. BUFALO
V6 3.5	99 - 01	MOTOR	FRONTAL / IZQ	PRÓXIMAMENTE	
		MOTOR	FRONTAL / DER	PRÓXIMAMENTE	
		TRANSMISIÓN	A9142		

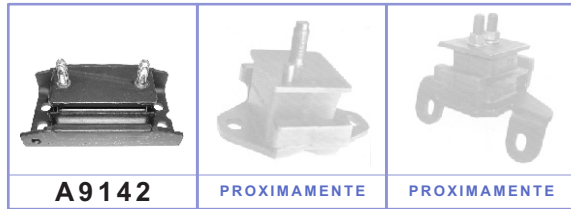

# I S U Z U

**PICK UP**

HOMBRE	MOTOR	MODELO	SOPORTE	ESPECIFICACIÓN	No. BUFALO
L4 2.2	96 - 97	96 - 00	TRANSMISIÓN	STD / 5 VEL	A2956
			MOTOR	FRONTAL / DER / IZQ / REPUESTO	933
			MOTOR	FRONTAL / IZQ	PRÓXIMAMENTE
			MOTOR	FRONTAL / DER	PRÓXIMAMENTE
			TRANSMISIÓN	AUT / 4 VEL	A2957
			TRANSMISIÓN	STD / 5 VEL	A2957
V6 4.3	97 - 00	MOTOR	FRONTAL / DER / IZQ	1122-A	
		TRANSMISIÓN	4 X 4	A2638	
		TRANSMISIÓN	TRACCIÓN TRASERA	930	

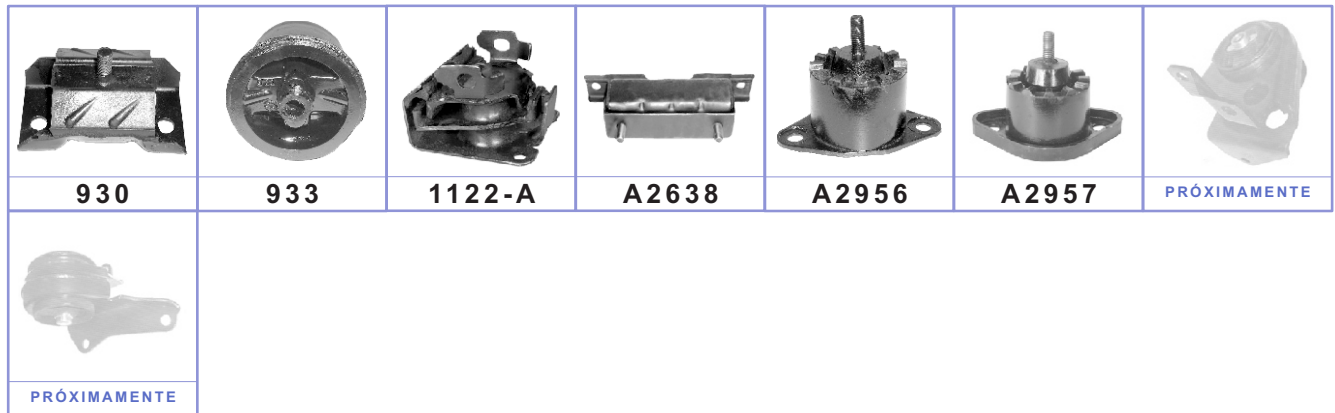

## CALIDAD Y GARANTÍA



# I S U Z U

**PICK UP**

PICK UP	MOTOR	MODELO	SOPORTE	ESPECIFICACIÓN	No. BUFALO
L4	1.8 1.9	81 - 87	MOTOR	FRONTAL / IZQ	PRÓXIMAMENTE
			TRANSMISIÓN		<b>A9143</b>
L4	2.2	81 - 86	MOTOR	FRONTAL / IZQ	PRÓXIMAMENTE
			MOTOR	FRONTAL / DER	PRÓXIMAMENTE
		81 - 87	MOTOR	FRONTAL / IZQ / <b>DIESEL</b>	<b>A8576</b>
			MOTOR	FRONTAL / DER / <b>DIESEL</b>	<b>A8577</b>
			TRANSMISIÓN		<b>A9143</b>
87	MOTOR	FRONTAL / DER / IZQ	PRÓXIMAMENTE		
L4	2.3	86 - 87	MOTOR	FRONTAL / IZQ	PRÓXIMAMENTE
			TRANSMISIÓN	AUT / STD	<b>A9143</b>
		86 - 95	TRANSMISIÓN	AUT	<b>A8870</b>
		88 - 95	MOTOR	FRONTAL / DER	PRÓXIMAMENTE
			MOTOR	FRONTAL / DER	PRÓXIMAMENTE
			TRANSMISIÓN	AUT	<b>A9143</b>
L4	2.6	87 - 95	MOTOR	FRONTAL / DER	<b>A8579</b>
			MOTOR	FRONTAL / IZQ	PRÓXIMAMENTE
			MOTOR	FRONTAL / DER	PRÓXIMAMENTE
			TRANSMISIÓN	AUT	<b>A9143</b>
			TRANSMISIÓN	STD	PRÓXIMAMENTE

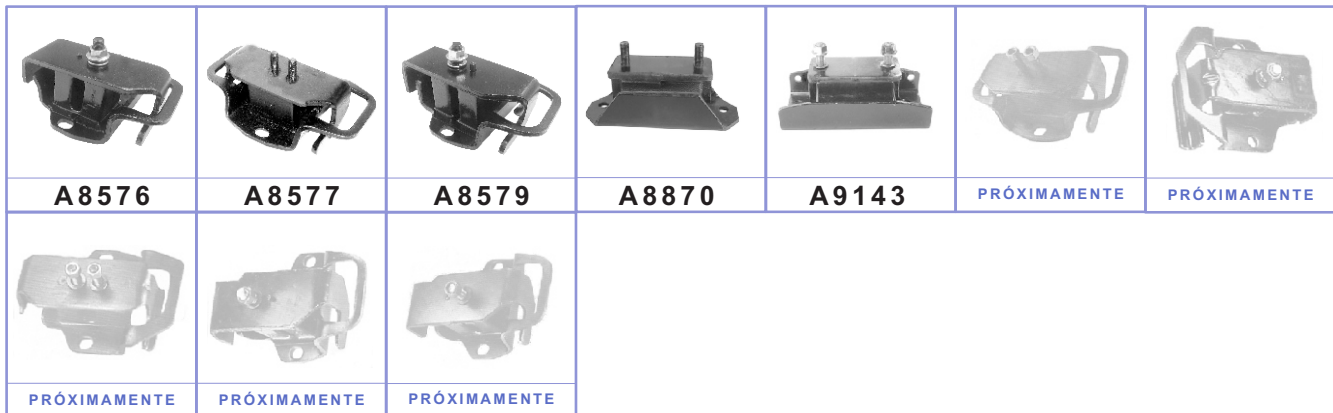

# I S U Z U

**CAMIONETAS VAN**





OASIS	MOTOR	MODELO	SOPORTE	ESPECIFICACIÓN	No. BUFALO
L4	2.2 2.3	96 - 00	MOTOR	FRONTAL	<b>A8432</b>
			MOTOR	FRONTAL	<b>A8074</b>
			MOTOR	TRASERO / CON VÁLVULA SELENOIDE	<b>A8984</b>
			MOTOR	SIN VÁLVULA SELENOIDE	<b>A8984</b>
			TRANSMISIÓN		<b>A8347</b>

CONTINÚA...

# I S U Z U

**CAMIONETAS VAN**







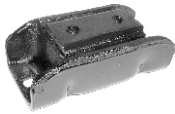

<b>OASIS</b>					
	<b>A8074</b>	<b>A8347</b>	<b>A8432</b>	<b>A8984</b>	<b>PRÓXIMAMENTE</b>

# J E E P

**TODO TERRENO**

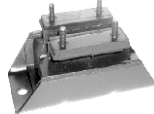
<b>CHEROKEE</b>	MOTOR	MODELO	SOPORTE	ESPECIFICACIÓN	No. <b>BUFALO</b>
<b>L4</b>	2.5	<b>04 - 07</b>	MOTOR	FRONTAL / IZQ	<b>A2569</b>
			MOTOR	FRONTAL / DER	<b>A2571</b>
			TRANSMISIÓN		<b>A2570</b>
<b>V6</b>	2.8	<b>84 - 86</b>	MOTOR	FRONTAL / DER / IZQ	<b>A2569</b>
			TRANSMISIÓN	FRONTAL / DER	<b>A2570</b>
<b>L6</b>	4.0	<b>87 - 99</b>	TRANSMISIÓN		<b>A2625</b>
		<b>87 - 01</b>	MOTOR	FRONTAL / DER / IZQ	<b>A2572</b>
		<b>90 - 99</b>	TRANSMISIÓN	STD / 4 X 4	<b>930</b>
<b>L6</b>	4.2	<b>74 - 83</b>	TRANSMISIÓN		<b>223</b>
		<b>90 - 99</b>	TRANSMISIÓN	STD / 4 X 4	<b>930</b>
<b>V8</b>	5.9	<b>74 - 83</b>	MOTOR	FRONTAL / DER / IZQ	<b>223</b>
			MOTOR	FRONTAL / IZQ	<b>728</b>
			MOTOR	FRONTAL / DER	<b>729</b>

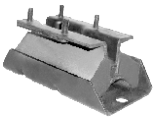
						
<b>223</b>	<b>728</b>	<b>729</b>	<b>930</b>	<b>A2569</b>	<b>A2570</b>	<b>A2571</b>
						
<b>A2572</b>	<b>A2625</b>					



# J E E P

**TODO TERRENO**

CJ-5, CJ-7	MOTOR	MODELO	SOPORTE	ESPECIFICACIÓN	No. BUFALO
	L4 2.5	80 - 86	MOTOR	FRONTAL / DER / IZQ	<b>A2446</b>



COMANCHE	MOTOR	MODELO	SOPORTE	ESPECIFICACIÓN	No. BUFALO
	L4 2.5	86 - 90	TRANSMISIÓN	AUT	<b>A2625</b>
			MOTOR	FRONTAL / IZQ	<b>A2569</b>
		86 - 92	MOTOR	FRONTAL / DER	<b>A2571</b>
			TRANSMISIÓN	STD / AUT	<b>A2570</b>
	2.8	86	MOTOR	FRONTAL / DER / IZQ	<b>A2569</b>
			TRANSMISIÓN	STD / AUT	<b>A2570</b>
L6 4.0	84 - 00	MOTOR	FRONTAL / DER / IZQ	<b>A2569</b>	
		TRANSMISIÓN		<b>A2570</b>	

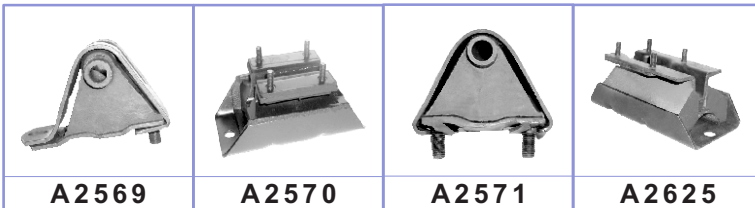

COMPASS	MOTOR	MODELO	SOPORTE	ESPECIFICACIÓN	No. BUFALO
	L4 2.4	07 - 10	MOTOR	FRONTAL	<b>A103-C</b>
			MOTOR	FRONTAL / DER	PRÓXIMAMENTE
			MOTOR	TRASERO / STD / REPUESTO	<b>A104</b>
			MOTOR	TRASERO / STD	PRÓXIMAMENTE
			MOTOR	FRONTAL / AUT / REPUESTO	<b>A10</b>
			MOTOR	TRASERO / AUT	PRÓXIMAMENTE
			TRANSMISIÓN		PRÓXIMAMENTE



GRAND CHEROKEE		MOTOR	MODELO	SOPORTE	ESPECIFICACIÓN	No. <i>BUFALO</i>
L6	4.0	93 - 95	TRANSMISIÓN		AUT / 4 VEL	<b>A2864HY</b>
			TRANSMISIÓN		STD / 5 VEL	<b>A2863</b>
			MOTOR		FRONTAL / DER / IZQ / REPUESTO	<b>935</b>
		93 - 98	MOTOR		FRONTAL / IZQ	<b>PRÓXIMAMENTE</b>
			MOTOR		FRONTAL / DER	<b>PRÓXIMAMENTE</b>
			TRANSMISIÓN			<b>A2828</b>
L6	4.2	99 - 04	MOTOR		FRONTAL / DER / IZQ / REPUESTO	<b>1114R</b>
			MOTOR		FRONTAL / IZQ	<b>PRÓXIMAMENTE</b>
			MOTOR		FRONTAL / DER	<b>PRÓXIMAMENTE</b>
			TRANSMISIÓN		AUT / 5 VEL / REPUESTO	<b>PRÓXIMAMENTE</b>
			TRANSMISIÓN		AUT / 5 VEL	<b>PRÓXIMAMENTE</b>
			TRANSMISIÓN		AUT / 4 VEL / REPUESTO	<b>1011</b>
			TRANSMISIÓN		AUT / 4 VEL	<b>PRÓXIMAMENTE</b>
V8	4.7	99 - 04	MOTOR		FRONTAL / DER / IZQ / REPUESTO	<b>1114R</b>
			MOTOR		FRONTAL / IZQ	<b>PRÓXIMAMENTE</b>
			MOTOR		FRONTAL / DER	<b>PRÓXIMAMENTE</b>
			TRANSMISIÓN		TRACCIÓN TRASERA	<b>PRÓXIMAMENTE</b>
			TRANSMISIÓN			<b>PRÓXIMAMENTE</b>
			TRANSMISIÓN		4 X 4	<b>1011</b>
			TRANSMISIÓN			<b>PRÓXIMAMENTE</b>
V8	5.2	93 - 96	TRANSMISIÓN		MOT. 5.2	<b>A2863</b>
			MOTOR		FRONTAL / DER / IZQ / REPUESTO A2808 y A2809	<b>935</b>
	5.9	93 - 98	MOTOR		FRONTAL / IZQ	<b>A2808</b>
			MOTOR		FRONTAL / DER	<b>A2809</b>
			TRANSMISIÓN			<b>A2828</b>

<b>935</b>	<b>1011</b>	<b>1114-A</b>	<b>A2808</b>	<b>A2809</b>	<b>A2828</b>	<b>A2863</b>
<b>A2864HY</b>	<b>PRÓXIMAMENTE</b>	<b>PRÓXIMAMENTE</b>	<b>PRÓXIMAMENTE</b>	<b>PRÓXIMAMENTE</b>	<b>PRÓXIMAMENTE</b>	<b>PRÓXIMAMENTE</b>
<b>PRÓXIMAMENTE</b>	<b>PRÓXIMAMENTE</b>	<b>PRÓXIMAMENTE</b>	<b>PRÓXIMAMENTE</b>			



# J E E P

**TODO TERRENO**

GRAND WAGONEER	MOTOR	MODELO	SOPORTE	ESPECIFICACIÓN	No. BUFALO
V8 5.2	93	MOTOR	FRONTAL / DER / IZQ / REPUESTO	A2808 Y A2809	<b>935</b>
		MOTOR	FRONTAL / DER		<b>A2808</b>
		MOTOR	FRONTAL / IZQ		<b>A2809</b>
		TRANSMISIÓN			<b>A2828</b>

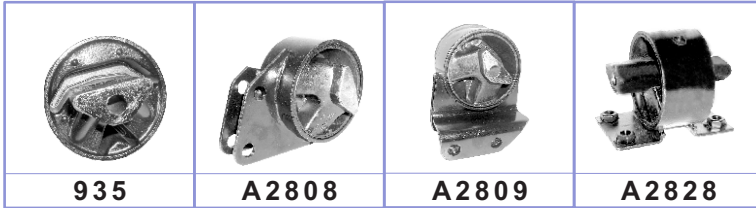

LIBERTY	MOTOR	MODELO	SOPORTE	ESPECIFICACIÓN	No. BUFALO
L4 2.4	02 - 04	MOTOR	FRONTAL / IZQ / REPUESTO		<b>1114-A</b>
		MOTOR	FRONTAL / IZQ		PRÓXIMAMENTE
		MOTOR	FRONTAL / DER / REPUESTO		<b>1114-A</b>
		MOTOR	FRONTAL / DER		PRÓXIMAMENTE
		TRANSMISIÓN	REPUESTO		PRÓXIMAMENTE
		TRANSMISIÓN			PRÓXIMAMENTE

V6 3.7	02 - 03	TRANSMISIÓN	AUT / TRACCIÓN TRASERA / REPUESTO	PRÓXIMAMENTE
		TRANSMISIÓN	AUT / TRACCIÓN TRASERA	PRÓXIMAMENTE
		TRANSMISIÓN	AUT / 4 X 4 / REPUESTO	PRÓXIMAMENTE
		TRANSMISIÓN	AUT / 4 X 4	PRÓXIMAMENTE
		TRANSMISIÓN	STD / 5 VEL / 4 X 4	PRÓXIMAMENTE
	02 - 04	TRANSMISIÓN	STD / TRACCIÓN TRASERA / REPUESTO	PRÓXIMAMENTE
		TRANSMISIÓN	STD / TRACCIÓN TRASERA	<b>1114-A</b>
	02 - 08	MOTOR	FRONTAL / IZQ / REPUESTO	PRÓXIMAMENTE
		MOTOR	FRONTAL / IZQ	<b>1114-A</b>
		MOTOR	FRONTAL / DER / REPUESTO	PRÓXIMAMENTE
		MOTOR	FRONTAL / DER	PRÓXIMAMENTE
		TRANSMISIÓN	REPUESTO	PRÓXIMAMENTE
		TRANSMISIÓN	AUT / 4 X 4 / TRACCIÓN TRASERA / REPUESTO	PRÓXIMAMENTE
		TRANSMISIÓN	AUT / 4 X 4 / TRACCIÓN TRASERA	PRÓXIMAMENTE
TRANSMISIÓN	STD / 5 VEL / 4 X 4	PRÓXIMAMENTE		



# J E E P

**TODO TERRENO**



PATRIOT		MOTOR	MODELO	SOPORTE	ESPECIFICACIÓN	No. BUFALO
L4	2.4	07 - 10	MOTOR	FRONTAL	<b>A 103-C</b>	
			MOTOR	FRONTAL / DER	PRÓXIMAMENTE	
			MOTOR	TRASERO / STD / REPUESTO	<b>A 104</b>	
			MOTOR	STD / TRASERO	PRÓXIMAMENTE	
			MOTOR	STD / TRASERO / REPUESTO	<b>A 10</b>	
			MOTOR	STD / TRASERO	PRÓXIMAMENTE	
			TRANSMISIÓN		PRÓXIMAMENTE	



WAGONEER		MOTOR	MODELO	SOPORTE	ESPECIFICACIÓN	No. BUFALO
L4	2.1	85	MOTOR	FRONTAL / DER / IZQ	<b>A 2569</b>	
			TRANSMISIÓN	AUT	<b>A 2625</b>	
			TRANSMISIÓN	STD	<b>A 2570</b>	
L4	2.5	84 - 87	MOTOR	FRONTAL / IZQ	<b>A 2569</b>	
			MOTOR	FRONTAL / DER	<b>A 2571</b>	
			TRANSMISIÓN	AUT	<b>A 2625</b>	
			TRANSMISIÓN	STD	<b>A 2570</b>	
V6	2.8	84 - 86	MOTOR	FRONTAL / DER / IZQ	<b>A 2569</b>	
			TRANSMISIÓN		<b>223</b>	
L6	4.0	87 - 90	MOTOR	FRONTAL / DER / IZQ	<b>A 2572</b>	
			TRANSMISIÓN		<b>A 2625</b>	
V8	5.9	72 - 83	MOTOR	FRONTAL / DER / IZQ	<b>729</b>	
			TRANSMISIÓN		<b>223</b>	

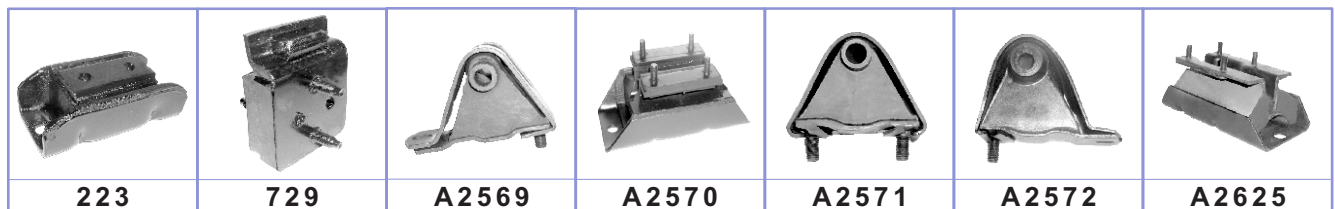

WRANGLER		MOTOR	MODELO	SOPORTE	ESPECIFICACIÓN	No. BUFALO
L4	2.4	03 - 06	MOTOR	FRONTAL / DER / IZQ	<b>A 2883</b>	
			TRANSMISIÓN			

CONTINÚA...



**J E E P**

**TODO TERRENO**

WRANGLER	MOTOR	MODELO	SOPORTE	ESPECIFICACIÓN	No. BUFALO
L4	2.5	87 - 95	MOTOR	FRONTAL / DER / IZQ	<b>A2569</b>
			TRANSMISIÓN		PRÓXIMAMENTE
		97 - 02	MOTOR	FRONTAL / DER / IZQ	<b>A2883</b>
			TRANSMISIÓN		<b>A2858</b>
L6	4.0	91 - 95	MOTOR	FRONTAL / DER / IZQ	<b>A2572</b>
			TRANSMISIÓN		PRÓXIMAMENTE
		97 - 06	MOTOR	FRONTAL / DER / IZQ	<b>A2883</b>
			TRANSMISIÓN		<b>A2858</b>
L6	4.2	87 - 90	MOTOR	FRONTAL / DER / IZQ	<b>A2572</b>
			TRANSMISIÓN		PRÓXIMAMENTE



MR

**CALIDAD Y GARANTÍA  
DE EXPORTACIÓN**



ES 250	MOTOR	MODELO	SOPORTE	ESPECIFICACIÓN	No. BUFALO
V6 2.5	90 - 91	MOTOR	FRONTAL / STD	PRÓXIMAMENTE	
		MOTOR	FRONTAL / AUT	PRÓXIMAMENTE	
		MOTOR	FRONTAL / DER / AUT / 4 VEL	PRÓXIMAMENTE	
		MOTOR	TRASERO	PRÓXIMAMENTE	
		TRANSMISIÓN	CENTRAL	<b>A 8208</b>	



ES 300	MOTOR	MODELO	SOPORTE	ESPECIFICACIÓN	No. BUFALO
V6 3.0	92 - 93	TRANSMISIÓN	STD / 5 VEL	<b>A 8529</b>	
		MOTOR	TRASERO	PRÓXIMAMENTE	
		TRANSMISIÓN	TORSIÓN / FRONTAL / DER	PRÓXIMAMENTE	
		TRANSMISIÓN	AUT / 4 VEL	PRÓXIMAMENTE	
		97 - 01	MOTOR	FRONTAL	PRÓXIMAMENTE
			MOTOR	TRASERO	PRÓXIMAMENTE
			MOTOR	TORSIÓN	<b>A 8995</b>
		02 - 03	MOTOR	TORSIÓN / FRONTAL / DER	PRÓXIMAMENTE
			TRANSMISIÓN	PRÓXIMAMENTE	



ES 330	MOTOR	MODELO	SOPORTE	ESPECIFICACIÓN	No. BUFALO
V6 3.3	04 - 06	MOTOR	TORSIÓN / FRONTAL / DER	PRÓXIMAMENTE	
		TRANSMISIÓN	PRÓXIMAMENTE		

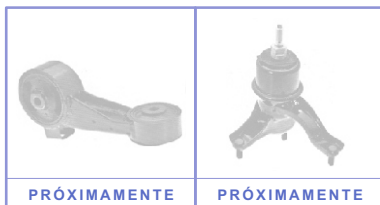



# LEXUS

**AUTOS**

ES 350	MOTOR	MODELO	SOPORTE	ESPECIFICACIÓN	No. BUFALO
	V6 3.5	07 - 09	TRANSMISIÓN		PRÓXIMAMENTE



# LEXUS

**TODO TERRENO**

RX 530 RX 400H	MOTOR	MODELO	SOPORTE	ESPECIFICACIÓN	No. BUFALO
	V6 3.3	04 - 07	TRANSMISIÓN		PRÓXIMAMENTE



# MAZDA



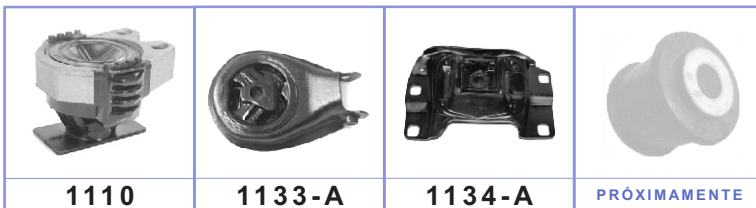

**AUTOS**

MAZDA 3	MOTOR	MODELO	SOPORTE	ESPECIFICACIÓN	No. BUFALO
	L4 2.0 2.3	08 - 10	MOTOR	FRONTAL	1110
			MOTOR	TRASERO / REPUESTO	PRÓXIMAMENTE
			MOTOR	TRASERO	1133-A
			TRANSMISIÓN		1134-A



MAZDA 5	MOTOR	MODELO	SOPORTE	ESPECIFICACIÓN	No. BUFALO
	L4 2.3	07 - 10	MOTOR	FRONTAL	1110
			MOTOR	TRASERO / REPUESTO	PRÓXIMAMENTE
			MOTOR	TRASERO	1133-A
			MOTOR		A3107
			TRANSMISIÓN		1134-A

CONTINÚA...

<b>MAZDA 5</b>					
	<b>1110</b>	<b>1133-A</b>	<b>1134-A</b>	<b>A3107</b>	<b>PRÓXIMAMENTE</b>





<b>MAZDA 6</b>	MOTOR	MODELO	SOPORTE	ESPECIFICACIÓN	No. <b>BUFALO</b>
<b>L4</b>	2.3	<b>03 - 06</b>	MOTOR	TRASERO	<b>A9195</b>
			MOTOR		<b>A3101</b>
<b>V6</b>	3.0	<b>03 - 08</b>	MOTOR	TORSIÓN / TRASERO	<b>PRÓXIMAMENTE</b>
			TRANSMISIÓN		<b>A3904</b>

			
<b>A3101</b>	<b>A3904</b>	<b>A9195</b>	<b>PRÓXIMAMENTE</b>













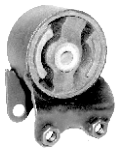

<b>323</b>	MOTOR	MODELO	SOPORTE	ESPECIFICACIÓN	No. <b>BUFALO</b>
<b>L4</b>	1.6	<b>86 - 89</b>	MOTOR	FRONTAL / DER / STD	<b>PRÓXIMAMENTE</b>
			MOTOR	TRASERO	<b>A8069</b>
		<b>88 - 94</b>	MOTOR	TRASERO / REPUESTO A2650	<b>920</b>
			MOTOR	TRASERO	<b>A2650</b>
		<b>89</b>	TRANSMISIÓN	STD	<b>A8073</b>
		<b>90 - 94</b>	MOTOR	FRONTAL / REPUESTO 964	<b>964R</b>
			MOTOR	FRONTAL	<b>964</b>
			MOTOR	FRONTAL / DER / REPUESTO	<b>921</b>
			MOTOR		<b>PRÓXIMAMENTE</b>
		<b>90 - 94</b>	TRANSMISIÓN	AUT / REPUESTO 963	<b>963R</b>
			TRANSMISIÓN	AUT	<b>963</b>

<b>L4</b>	1.8	<b>90 - 91</b>	MOTOR	FRONTAL / REPUESTO 964	<b>964R</b>
			MOTOR	FRONTAL	<b>964</b>
			MOTOR	FRONTAL / DER / REPUESTO	<b>921</b>
			MOTOR	FRONTAL / DER	<b>PRÓXIMAMENTE</b>
			TRANSMISIÓN	STD / REPUESTO A2650	<b>920</b>
			TRANSMISIÓN	STD	<b>A2650</b>
			TRANSMISIÓN	AUT / REPUESTO 963	<b>963R</b>
			TRANSMISIÓN	AUT	<b>963</b>

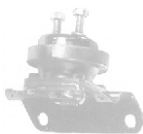

						
<b>920</b>	<b>921</b>	<b>963</b>	<b>963-R</b>	<b>964</b>	<b>964-R</b>	<b>A2650</b>

323				
	<b>A8069</b>	<b>A8073</b>	PRÓXIMAMENTE	PRÓXIMAMENTE

626	MOTOR	MODELO	SOPORTE	ESPECIFICACIÓN	No. BUFALO
<b>L4</b>	2.0	<b>83 - 87</b>	MOTOR	FRONTAL / DER / STD	PRÓXIMAMENTE
			MOTOR	TRASERO / STD / AUT	PRÓXIMAMENTE
			TRANSMISIÓN	TRASERO	PRÓXIMAMENTE
		<b>86 - 87</b>	TRANSMISIÓN	STD	PRÓXIMAMENTE
			MOTOR	FRONTAL / DER	<b>A8074</b>
		<b>93 - 97</b>	MOTOR	FRONTAL / AUT / STD	<b>A8073</b>
			MOTOR	TRASERO / STD	PRÓXIMAMENTE
		<b>93 - 01</b>	TRANSMISIÓN	CENTRAL / INF / STD	PRÓXIMAMENTE
			TRANSMISIÓN	CENTRAL / INF / AUT	<b>A9087</b>
		<b>94 - 02</b>	TRANSMISIÓN	AUT	<b>A8691</b>
<b>01</b>	MOTOR	FRONTAL / DER	<b>A8074</b>		
<b>L4</b>	2.2	<b>88 - 91</b>	MOTOR	FRONTAL / STD	PRÓXIMAMENTE
			MOTOR	TRASERO / STD / TURBO	PRÓXIMAMENTE
			TRANSMISIÓN	AUT / TURBO	<b>A8516</b>
		<b>88 - 92</b>	MOTOR	FRONTAL / DER / AUT / STD	PRÓXIMAMENTE
			MOTOR	TRASERO / AUT	PRÓXIMAMENTE
			MOTOR	TRASERO / STD	PRÓXIMAMENTE
		<b>90 - 92</b>	TRANSMISIÓN	AUT	<b>A8516</b>
<b>V6</b>	2.5	<b>93 - 97</b>	MOTOR	TRASERO / AUT	PRÓXIMAMENTE
			MOTOR	FRONTAL	<b>A8073</b>
		<b>93 - 02</b>	MOTOR	FRONTAL / DER	<b>A8074</b>
			TRANSMISIÓN	CENTRAL / INFERIOR / STD	PRÓXIMAMENTE
			TRANSMISIÓN	CENTRAL / INFERIOR / AUT	<b>A9087</b>
		<b>98 - 02</b>	MOTOR	TRASERO / STD	PRÓXIMAMENTE

						
<b>A8073</b>	<b>A8074</b>	<b>A8516</b>	<b>A8691</b>	<b>A9087</b>	PRÓXIMAMENTE	PRÓXIMAMENTE
						
PRÓXIMAMENTE	PRÓXIMAMENTE	PRÓXIMAMENTE	PRÓXIMAMENTE	PRÓXIMAMENTE	PRÓXIMAMENTE	PRÓXIMAMENTE

CONTINUA...

<b>626</b>			
	PROXIMAMENTE	PROXIMAMENTE	PROXIMAMENTE

<b>GLC</b>	MOTOR	MODELO	SOPORTE	ESPECIFICACIÓN	<i>No. BUFALO</i>
	<b>L4</b> 1.5	<b>81 - 82</b>	MOTOR	FRONTAL	PRÓXIMAMENTE
		<b>81 - 85</b>	MOTOR	FRONTAL / DER	PRÓXIMAMENTE

	
PROXIMAMENTE	PROXIMAMENTE

<b>MIATA</b>	MOTOR	MODELO	SOPORTE	ESPECIFICACIÓN	<i>No. BUFALO</i>
	<b>L4</b> 1.6/1.8	<b>90 - 97</b>	MOTOR	FRONTAL / DER / IZQ	PRÓXIMAMENTE

PROXIMAMENTE

<b>MILLENNIA</b>	MOTOR	MODELO	SOPORTE	ESPECIFICACIÓN	<i>No. BUFALO</i>
	<b>V6</b> 2.5	<b>95 - 02</b>	TRANSMISIÓN		PRÓXIMAMENTE

PROXIMAMENTE

# CALIDAD Y GARANTÍA



MR

# M A Z D A

**AUTOS**

MX-3	MOTOR	MODELO	SOPORTE	ESPECIFICACIÓN	No. BUFALO
L4	1.6	92 - 93	MOTOR	FRONTAL / DER	PROXIMAMENTE
			MOTOR	FRONTAL / REPUESTO 964	964 R
			MOTOR	FRONTAL / MOD. 92 STD / MOD. 92-93 AUT	964
		92 - 96	MOTOR	FRONTAL / DER / REPUESTO 921	A2649
			MOTOR	TRASERO / REPUESTO 963	963 R
			MOTOR	TRASERO / MOD. 92-96 STD / MOD 92-93 AUT	963
			TRANSMISIÓN	AUT / STD / REPUESTO A2650	920
			TRANSMISIÓN	MOD. 92-96 STD / MOD 92-93 AUT	A2912
		94 - 96	MOTOR	FRONTAL / AUT	978
			MOTOR	FRONTAL / AUT / REPUESTO 978	978-R
			MOTOR	FRONTAL / DER	921
		TRANSMISIÓN	AUT	A2650	

L4	1.8	91 - 94	MOTOR	TRASERO / REPUESTO 963	963 R
			MOTOR		963
			TRANSMISIÓN	REPUESTO A2650	920
			TRANSMISIÓN		A2650

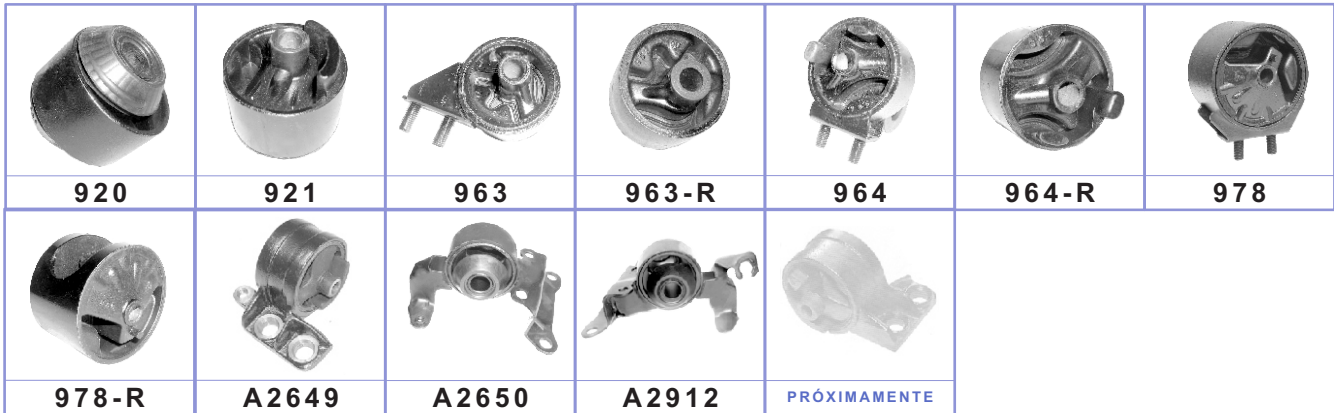













MX-6	MOTOR	MODELO	SOPORTE	ESPECIFICACIÓN	No. BUFALO
L4	2.0	93	MOTOR	TRASERO / AUT	PROXIMAMENTE
			MOTOR	FRONTAL / STD	A8073
			MOTOR	FRONTAL / DER	A8073
		93 - 97	MOTOR	TRASERO / STD	PROXIMAMENTE
			TRANSMISIÓN	CENTRAL / INFERIOR / STD	PROXIMAMENTE
			TRANSMISIÓN	CENTRAL / INFERIOR / AUT	A9087
		94 - 97	TRANSMISIÓN	AUT	A8691

L4	2.2	88 - 92	MOTOR	FRONTAL / STD	PROXIMAMENTE
			MOTOR	FRONTAL / DER	PROXIMAMENTE
			MOTOR	TRASERO / STD / CON TURBO	PROXIMAMENTE
			MOTOR	TRASERO / AUT	PROXIMAMENTE
			MOTOR	TRASERO / STD	PROXIMAMENTE
			TRANSMISIÓN	AUT / CON TURBO	A8516
			TRANSMISIÓN	AUT	A8516

CONTINÚA...

MX-6	MOTOR	MODELO	SOPORTE	ESPECIFICACIÓN	No. BUFALO
V6 2.5	93 - 97	MOTOR	FRONTAL / STD	<b>A 8073</b>	
		MOTOR	FRONTAL / DER	<b>A 8074</b>	
		MOTOR	TRASERO / STD	PRÓXIMAMENTE	
		TRANSMISIÓN	CENTRAL / INFERIOR / STD	PRÓXIMAMENTE	
		TRANSMISIÓN	CENTRAL / INFERIOR / AUT	<b>A 9087</b>	



						
<b>A 8073</b>	<b>A 8074</b>	<b>A 8516</b>	<b>A 8691</b>	<b>A 9087</b>	PRÓXIMAMENTE	PRÓXIMAMENTE
						
PRÓXIMAMENTE	PRÓXIMAMENTE	PRÓXIMAMENTE	PRÓXIMAMENTE	PRÓXIMAMENTE	PRÓXIMAMENTE	

PROTEGE	MOTOR	MODELO	SOPORTE	ESPECIFICACIÓN	No. BUFALO
L4 1.5	95 - 98	MOTOR	FRONTAL / STD	PRÓXIMAMENTE	
		MOTOR	FRONTAL / AUT	<b>978</b>	
		MOTOR	FRONTAL / DER	PRÓXIMAMENTE	
		MOTOR	TRASERO	PRÓXIMAMENTE	
		TRANSMISIÓN		<b>A 2912</b>	
L4 1.6	99 - 01	MOTOR	FRONTAL	PRÓXIMAMENTE	
L4 1.8	90 - 94	MOTOR	FRONTAL / REPUESTO 964	<b>964R</b>	
		MOTOR	FRONTAL	<b>964</b>	
		MOTOR	FRONTAL / DER / REPUESTO 2649	<b>921</b>	
		MOTOR	FRONTAL / DER	<b>A 2649</b>	
		MOTOR	TRASERO / AUT / REPUESTO A2650	<b>920</b>	
		MOTOR	TRASERO / AUT	<b>A 2650</b>	
		TRANSMISIÓN	REPUESTO 963	<b>963-R</b>	
		TRANSMISIÓN		<b>963</b>	
	95 - 98	MOTOR	FRONTAL / AUT	<b>978</b>	
		MOTOR	FRONTAL / AUT / REPUESTO 978	<b>978-R</b>	
		MOTOR	FRONTAL / DER	PRÓXIMAMENTE	
		MOTOR	TRASERO	PRÓXIMAMENTE	
		TRANSMISIÓN	REPUESTO A2912	<b>920</b>	
		TRANSMISIÓN		<b>A 2912</b>	
		99 - 00	MOTOR	FRONTAL / SUPERIOR	PRÓXIMAMENTE
L4 2.0	01 - 03	MOTOR	FRONTAL	PRÓXIMAMENTE	



# M A Z D A



**AUTOS**

<b>PROTEGE</b>						
	<b>920</b>	<b>921</b>	<b>963</b>	<b>963-R</b>	<b>964</b>	<b>964-R</b>
						
<b>978</b>	<b>978-R</b>	<b>A2649</b>	<b>A2650</b>	<b>A2912</b>	<b>PRÓXIMAMENTE</b>	<b>PRÓXIMAMENTE</b>
						
<b>PRÓXIMAMENTE</b>	<b>PRÓXIMAMENTE</b>					

# M A Z D A

**TODOS TERRENOS**

NAVAJO	MOTOR	MODELO	SOPORTE	ESPECIFICACIÓN	No. BUFALO
	V6 2.6	91 - 94	MOTOR	FRONTAL / IZQ	<b>A2643</b>
			MOTOR	FRONTAL / DER	<b>A2641</b>
		92 - 94	TRANSMISIÓN	AUT / STD / TRACCIÓN TRASERA	<b>941</b>

		
<b>941</b>	<b>A2641</b>	<b>A2643</b>

MAZDA CX-7	MOTOR	MODELO	SOPORTE	ESPECIFICACIÓN	No. BUFALO
	L4 2.5		TRANSMISIÓN		<b>A3109</b>

<b>A3109</b>



# M A Z D A

**TODO TERRENO**



TRIBUTE	MOTOR	MODELO	SOPORTE	ESPECIFICACIÓN	No. <i>BUFALO</i>
	L4 2.0	01 - 06	MOTOR	FRONTAL	<b>1096</b>
			MOTOR	FRONTAL / DER	<b>A3057</b>
			TRANSMISIÓN		<b>A3037</b>



# M A Z D A

**PICK UP**

B1600 / B1800	MOTOR	MODELO	SOPORTE	ESPECIFICACIÓN	No. <i>BUFALO</i>
	L4 1.6 1.8	72 - 78	MOTOR	FRONTAL / IZQ	<b>A2775</b>
			MOTOR	FRONTAL / DER	<b>A2774</b>

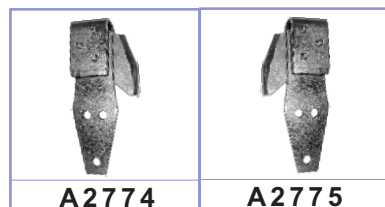

B2000	MOTOR	MODELO	SOPORTE	ESPECIFICACIÓN	No. <i>BUFALO</i>
	L4 2.0	79 - 84	MOTOR	FRONTAL / IZQ	<b>A2775</b>
			MOTOR	FRONTAL / DER	<b>A2774</b>
			TRANSMISIÓN		<b>PRÓXIMAMENTE</b>
		86 - 87	MOTOR	FRONTAL / DER / IZQ	<b>PRÓXIMAMENTE</b>
			TRANSMISIÓN		<b>PRÓXIMAMENTE</b>
			86 - 92	MOTOR	FRONTAL / DER / IZQ





# M A Z D A

PICK UP

B2200	MOTOR	MODELO	SOPORTE	ESPECIFICACIÓN	No. BUFALO
L4	2.2	82 - 84	MOTOR	FRONTAL / IZQ	<b>A2775</b>
			MOTOR	FRONTAL / DER	<b>A2774</b>
		87 - 93	MOTOR	FRONTAL / DER / IZQ	PRÓXIMAMENTE
			TRANSMISIÓN		PRÓXIMAMENTE

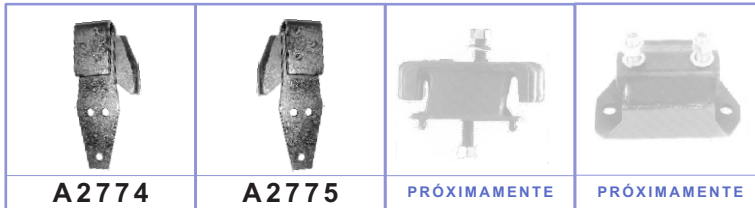

B2200	MOTOR	MODELO	SOPORTE	ESPECIFICACIÓN	No. BUFALO	
B2300	L4	2.0	86 - 92	MOTOR	FRONTAL / DER / IZQ	<b>972</b>
L4	2.3	94 - 97	MOTOR	FRONTAL / DER / IZQ	<b>A2698</b>	
			TRANSMISIÓN		<b>941</b>	

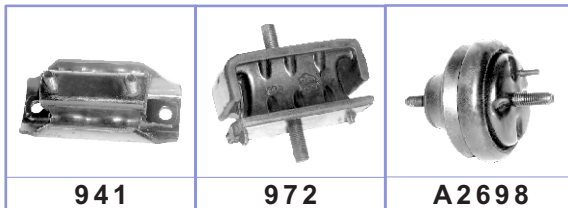

B2600	MOTOR	MODELO	SOPORTE	ESPECIFICACIÓN	No. BUFALO
L4	2.6	79 - 93	TRANSMISIÓN		<b>A8095</b>
			MOTOR	FRONTAL / DER / IZQ	<b>A8084</b>
		87 - 93	TRANSMISIÓN	4 X 4	PRÓXIMAMENTE
			TRANSMISIÓN	TRACCIÓN TRASERA	PRÓXIMAMENTE
		89 - 93	MOTOR	FRONTAL / DER / IZQ	<b>1115-A</b>







B3000	MOTOR	MODELO	SOPORTE	ESPECIFICACIÓN	No. BUFALO
V6	3.0	94 - 97	MOTOR	FRONTAL / IZQ / 4 X 4 / TRACCIÓN TRASERA	<b>A2643</b>
			MOTOR	FRONTAL / DER / TRACCIÓN TRASERA	<b>A2640</b>
		94 - 06	MOTOR	FRONTAL / DER / 4 X 4	<b>A2641</b>
			TRANSMISIÓN	MOD. 94-97 TRACCIÓN TRASERA / MOD. 98-06 4 X 4	<b>941</b>
		98 - 06	MOTOR	FRONTAL / DER / IZQ / TRACCIÓN TRASERA	<b>A2853</b>

CONTINÚA...

# M A Z D A

PICK UP

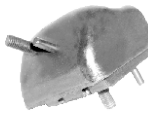

<b>B3000</b>					
	<b>941</b>	<b>A2640</b>	<b>A2641</b>	<b>A2643</b>	<b>A2853</b>

<b>B4000</b>	MOTOR	MODELO	SOPORTE	ESPECIFICACIÓN	No. <i>BUFALO</i>
V6 4.0	MOTOR	94 - 97	MOTOR	FRONTAL / IZQ / 4 X 4	<b>A2643</b>
			MOTOR	FRONTAL / IZQ / TRACCIÓN TRASERA	<b>A2642</b>
			MOTOR	FRONTAL / DER	<b>A2641</b>
	MOTOR	98 - 06	TRANSMISIÓN		<b>941</b>
			MOTOR	FRONTAL / DER / 2 X 2	<b>A2853</b>
			TRANSMISIÓN	4 X 4	<b>941</b>

				
<b>941</b>	<b>A2641</b>	<b>A2642</b>	<b>A2643</b>	<b>A2853</b>

# M A Z D A

CAMIONETAS VAN

<b>MPV</b>	MOTOR	MODELO	SOPORTE	ESPECIFICACIÓN	No. <i>BUFALO</i>
V6 3.0	L4 2.2	89 - 94	MOTOR	FRONTAL / DER / IZQ	<b>1115-A</b>
			MOTOR	FRONTAL / DER / IZQ	<b>1115-A</b>
			TRANSMISIÓN		<b>A8095</b>
		89 - 00	MOTOR	FRONTAL / DER / IZQ	<b>1115-B</b>

		
<b>1115-A</b>	<b>1115-B</b>	<b>A8095</b>



# MERCEDES BENZ

**AUTOS**

190D	MOTOR	MODELO	SOPORTE	ESPECIFICACIÓN	No. BUFALO
L5 2.5		86 - 89	MOTOR	FRONTAL / DER / IZQ / DIESEL	<b>A8662HY</b>
		87	MOTOR	FRONTAL / DER / IZQ / TURBO DIESEL	PRÓXIMAMENTE



**A8662HY**

PRÓXIMAMENTE

190E	MOTOR	MODELO	SOPORTE	ESPECIFICACIÓN	No. BUFALO
L4 2.3		84 - 98	MOTOR	FRONTAL / DER / IZQ	<b>A8662HY</b>
		91 - 93	MOTOR	FRONTAL / DER / IZQ	<b>A8662HY</b>
L6 2.6		87 - 93	MOTOR	FRONTAL / DER / IZQ	<b>A8662HY</b>



**A8662HY**

300CE	MOTOR	MODELO	SOPORTE	ESPECIFICACIÓN	No. BUFALO
L3	3.0	88 - 89	MOTOR	FRONTAL / DER / IZQ	<b>A8662HY</b>
		93	MOTOR	FRONTAL / DER / IZQ	<b>A8662HY</b>



**A8662HY**

300D	MOTOR	MODELO	SOPORTE	ESPECIFICACIÓN	No. BUFALO
L5 2.5		78 - 85	TRANSMISIÓN		PRÓXIMAMENTE
		90 - 93	MOTOR	FRONTAL / DER / IZQ	PRÓXIMAMENTE

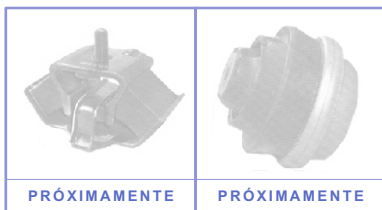

PRÓXIMAMENTE

PRÓXIMAMENTE

300D	MOTOR	MODELO	SOPORTE	ESPECIFICACIÓN	No. BUFALO
	L6 2.6	90 - 92	MOTOR	FRONTAL / DER / IZQ	PRÓXIMAMENTE
	L6 3.2	93	MOTOR	FRONTAL / DER / IZQ	<b>A 8662HY</b>



**A 8662HY**

PRÓXIMAMENTE

300 TD / 300 TE	MOTOR	MODELO	SOPORTE	ESPECIFICACIÓN	No. BUFALO
	L4 2.4	78 - 85	TRANSMISIÓN		<b>A 8662HY</b>
		87 - 89	MOTOR	FRONTAL / DER / IZQ	PRÓXIMAMENTE

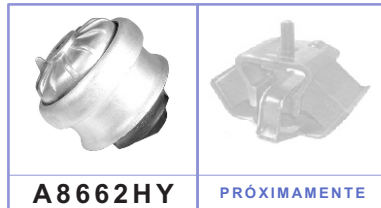

**A 8662HY**

PRÓXIMAMENTE

E320	MOTOR	MODELO	SOPORTE	ESPECIFICACIÓN	No. BUFALO
	L6 3.2	94 - 95	MOTOR	FRONTAL / DER / IZQ	<b>A 8662HY</b>



**A 8662HY**

SPRINTER	MOTOR	MODELO	SOPORTE	ESPECIFICACIÓN	No. BUFALO
	L4 2.1	03 - 11	MOTOR	FRONTAL / DER / IZQ / DIESEL	PRÓXIMAMENTE
	L5 2.7		TRANSMISIÓN	DIESEL	PRÓXIMAMENTE

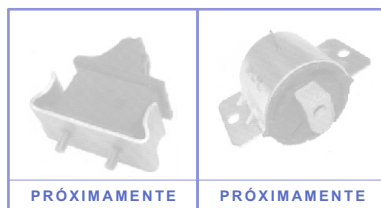

PRÓXIMAMENTE

PRÓXIMAMENTE



# MITSUBISHI

**AUTOS**

ECLIPSE		MOTOR	MODELO	SOPORTE	ESPECIFICACIÓN	No. BUFALO
L4	1.5	93 - 96	TRANSMISIÓN			<b>A 8099</b>
			MOTOR		AUT / STD / TRASERO	<b>A 8112</b>
L4	1.8	90 - 94	MOTOR		FRONTAL	PRÓXIMAMENTE
			MOTOR		TRASERO / AUT	PRÓXIMAMENTE
			MOTOR		FRONTAL	<b>A 8103</b>
L4	2.0	90 - 94	MOTOR		FRONTAL / TRACCIÓN DELANTERA	PRÓXIMAMENTE
			MOTOR		TRASERO / AUT	PRÓXIMAMENTE
		95 - 99	MOTOR		FRONTAL	PRÓXIMAMENTE
			MOTOR		FRONTAL / IZQ	<b>A 8793</b>
			MOTOR		TRASERO / STD / TURBO	<b>A 8798</b>
			TRANSMISIÓN		STD	<b>A 9161</b>
			TRANSMISIÓN		STD	<b>A 8793</b>
L4	2.4	96 - 99	MOTOR		FRONTAL	PRÓXIMAMENTE
			MOTOR		FRONTAL / IZQ	<b>A 8184</b>
			MOTOR		TRASERO	<b>A 8798</b>
			TRANSMISIÓN		STD	<b>A 9161</b>
			TRANSMISIÓN		AUT	<b>A 9058</b>
			MOTOR		FRONTAL / AUT	<b>A 9160</b>
			MOTOR		TRASERO / AUT	<b>A 9161</b>
V6	3.0	00 - 05	MOTOR		FRONTAL	<b>A 9187</b>
			MOTOR		TRASERO	PRÓXIMAMENTE
			TRANSMISIÓN		AUT	PRÓXIMAMENTE

<b>A 8099</b>	<b>A 8103</b>	<b>A 8112</b>	<b>A 8793</b>	<b>A 8798</b>	<b>A 9058</b>	<b>A 9160</b>
<b>A 9161</b>	<b>A 9187</b>	<b>A 9184</b>	PRÓXIMAMENTE	PRÓXIMAMENTE	PRÓXIMAMENTE	PRÓXIMAMENTE
PRÓXIMAMENTE						

ECLIPSE SS		MOTOR	MODELO	SOPORTE	ESPECIFICACIÓN	No. BUFALO
L4	2.0	95 - 99	TRANSMISIÓN	STD / <b>TURBO</b>	<b>A 8793</b>	
			TRANSMISIÓN	AUT / <b>TURBO</b>	<b>A 9058</b>	
	2.4	00 - 05	MOTOR	TRASERO / AUT / <b>SPIDER</b>	<b>A 9161</b>	



DIAMANTE		MOTOR	MODELO	SOPORTE	ESPECIFICACIÓN	No. BUFALO
V6	3.5	97 - 04	MOTOR	FRONTAL / DER	<b>A 9189</b>	
	3.8		MOTOR	FRONTAL	<b>A 9193</b>	



GALANT		MOTOR	MODELO	SOPORTE	ESPECIFICACIÓN	No. BUFALO
L4	1.5	74 - 77	MOTOR	FRONTAL / DER / IZQ	<b>971</b>	
			MOTOR	TRASERO	<b>PRÓXIMAMENTE</b>	

L4	2.0	89 - 93	MOTOR	FRONTAL / TRACCIÓN DELANTERA	<b>PRÓXIMAMENTE</b>
			MOTOR	TRASERO	<b>PRÓXIMAMENTE</b>

L4	2.4	85 - 87	MOTOR	FRONTAL	<b>PRÓXIMAMENTE</b>
			MOTOR	TRASERO / SUSPENSIÓN STD	<b>PRÓXIMAMENTE</b>
		94 - 96	MOTOR	FRONTAL / DER / STD	<b>PRÓXIMAMENTE</b>
			94 - 98	MOTOR	FRONTAL
		MOTOR		TRASERO	<b>A 8798</b>
		TRANSMISIÓN		STD	<b>A 9161</b>
		94 - 98	TRANSMISIÓN	AUT	<b>PRÓXIMAMENTE</b>
			99 - 03	MOTOR	FRONTAL / DER
		MOTOR		TRASERO	<b>A 8798</b>
		TRANSMISIÓN			<b>PRÓXIMAMENTE</b>
		99 - 05	MOTOR	FRONTAL	<b>A 9160</b>
			00 - 05	MOTOR	FRONTAL / AUT

V6	3.0	99 - 03	MOTOR	FRONTAL / DER	<b>A 9187</b>
			MOTOR	TRASERO	<b>PRÓXIMAMENTE</b>
			TRANSMISIÓN	AUT	<b>PRÓXIMAMENTE</b>

CONTINÚA...



# MITSUBISHI

**AUTOS**

GALANT						
<b>971</b>	<b>A8792</b>	<b>A8798</b>	<b>A9160</b>	<b>A9187</b>	<b>PRÓXIMAMENTE</b>	
<b>PRÓXIMAMENTE</b>	<b>PRÓXIMAMENTE</b>	<b>PRÓXIMAMENTE</b>	<b>PRÓXIMAMENTE</b>	<b>PRÓXIMAMENTE</b>	<b>PRÓXIMAMENTE</b>	<b>PRÓXIMAMENTE</b>
<b>PRÓXIMAMENTE</b>						

LANCER		MOTOR	MODELO	SOPORTE	ESPECIFICACIÓN	No. BUFALO
<b>L4</b>	<b>2.0</b>	<b>02 - 06</b>	MOTOR	FRONTAL / DER	<b>A9188</b>	





MIRAGE		MOTOR	MODELO	SOPORTE	ESPECIFICACIÓN	No. BUFALO
<b>L4</b>	<b>1.5</b>	<b>87 - 88</b>	MOTOR	FRONTAL	<b>PRÓXIMAMENTE</b>	
			MOTOR	TRASERO	<b>PRÓXIMAMENTE</b>	
		<b>93 - 96</b>	MOTOR	FRONTAL / TRASERO / AUT / STD	<b>A8103</b>	
			MOTOR	TRASERO	<b>A8103</b>	
			MOTOR	FRONTAL / IZQ	<b>PRÓXIMAMENTE</b>	
			TRANSMISIÓN		<b>A8099</b>	
		<b>97 - 02</b>	MOTOR	FRONTAL	<b>PRÓXIMAMENTE</b>	
			MOTOR	TRASERO	<b>A8819</b>	
			MOTOR	FRONTAL	<b>A9037</b>	
			MOTOR	TRASERO	<b>A9059</b>	
<b>L4</b>	<b>1.8</b>	<b>93 - 94</b>	MOTOR	FRONTAL / AUT / STD	<b>A8103</b>	
			MOTOR	TRASERO	<b>PRÓXIMAMENTE</b>	
		<b>93 - 96</b>	MOTOR	TRASERO	<b>PRÓXIMAMENTE</b>	
			MOTOR	TRASERO	<b>PRÓXIMAMENTE</b>	
<b>97 - 02</b>	MOTOR	TRASERO	<b>PRÓXIMAMENTE</b>			

CONTINÚA...





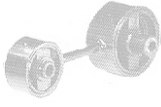

<b>MIRAGE</b>						
	<b>A8099</b>	<b>A8103</b>	<b>A8819</b>	<b>A9037</b>	<b>A9059</b>	PRÓXIMAMENTE
						
PRÓXIMAMENTE	PRÓXIMAMENTE	PRÓXIMAMENTE				

<b>PRECIS</b>	MOTOR	MODELO	SOPORTE	ESPECIFICACIÓN	No. <b>BUFALO</b>
<b>L4</b>	<b>2.5</b>	<b>87 - 89</b>	MOTOR	TORSIÓN / FRONTAL / DER / AUT	PRÓXIMAMENTE
			MOTOR	TORSIÓN / TRASERA	PRÓXIMAMENTE
		<b>90 - 94</b>	MOTOR	FRONTAL	PRÓXIMAMENTE
			MOTOR	TORSIÓN / FRONTAL	PRÓXIMAMENTE

			
PRÓXIMAMENTE	PRÓXIMAMENTE	PRÓXIMAMENTE	PRÓXIMAMENTE

<b>STARION</b>	MOTOR	MODELO	SOPORTE	ESPECIFICACIÓN	No. <b>BUFALO</b>
<b>L4</b>	<b>2.6</b>	<b>83 - 89</b>	MOTOR	FRONTAL	PRÓXIMAMENTE
			MOTOR	FRONTAL / IZQ	PRÓXIMAMENTE
			MOTOR	FRONTAL / DER	<b>971</b>
			TRANSMISIÓN	STD	<b>A2730</b>

			
<b>971</b>	<b>A2730</b>	PRÓXIMAMENTE	PRÓXIMAMENTE



# MITSUBISHI

**TODO TERRENO**

MONTERO	MOTOR	MODELO	SOPORTE	ESPECIFICACIÓN	No. BUFALO
V6	2.6	79 - 99	TRANSMISIÓN		<b>A 8111</b>
	3.0	83 - 89	MOTOR	FRONTAL / DER / IZQ	PRÓXIMAMENTE



**A 8111**

PRÓXIMAMENTE

# MITSUBISHI

**PICK UP**

MIGHTY MAX	MOTOR	MODELO	SOPORTE	ESPECIFICACIÓN	No. BUFALO
L4	2.0	83 - 89	MOTOR	FRONTAL / DER / IZQ	<b>971</b>
		87 - 89	TRANSMISIÓN		<b>A 2730</b>
		95 - 98	TRANSMISIÓN		<b>A 9174</b>
L4	2.3	83 - 85	MOTOR	FRONTAL / IZQ	<b>971</b>
			MOTOR	FRONTAL / DER	PRÓXIMAMENTE
L4	2.4	90 - 96	MOTOR	FRONTAL / DER / IZQ / 4 X 4	PRÓXIMAMENTE
			MOTOR	FRONTAL / DER / IZQ / 2 X 2	<b>971</b>
			TRANSMISIÓN	STD / 2 X 2	<b>A 2730</b>
L4	2.6	83 - 89	MOTOR	FRONTAL / DER / IZQ	<b>971</b>
		87 - 89	TRANSMISIÓN	2 X 2	<b>A 2730</b>
V6	3.0	90 - 94	MOTOR	FRONTAL / DER / IZQ	PRÓXIMAMENTE
			TRANSMISIÓN		<b>A 2730</b>



**971**

**A 2730**

**A 9174**

PRÓXIMAMENTE

200 SX (USA)		MOTOR	MODELO	SOPORTE	ESPECIFICACIÓN	No. BUFALO
L4	1.6	95 - 98	MOTOR	FRONTAL / STD	<b>900</b>	
			MOTOR	FRONTAL / DER / <i>REPUESTO A8122</i>	<b>965</b>	
			MOTOR	FRONTAL / DER	<b>A8122</b>	
			MOTOR	TRASERO / AUT / STD / <i>REPUESTO A8701</i>	<b>1012</b>	
			MOTOR	TRASERO / AUT / STD	<b>A8701</b>	
			TRANSMISIÓN	AUT	<b>PRÓXIMAMENTE</b>	
			TRANSMISIÓN	STD / <i>REPUESTO</i>	<b>874</b>	
			TRANSMISIÓN	STD	<b>PRÓXIMAMENTE</b>	

L4	2.0	95 - 98	MOTOR	FRONTAL / STD	<b>900</b>
			MOTOR	FRONTAL / STD / <i>REPUESTO 900</i>	<b>900-R</b>
			MOTOR	FRONTAL / DER / <i>REPUESTO</i>	<b>965</b>
			MOTOR	FRONTAL / DER	<b>PRÓXIMAMENTE</b>
			MOTOR	TRASERO / <i>REPUESTO A8701</i>	<b>1012</b>
			MOTOR	TRASERO / AUT / STD	<b>A8701</b>
			TRANSMISIÓN	<i>REPUESTO</i>	<b>874</b>
			TRANSMISIÓN		<b>PRÓXIMAMENTE</b>



210 / B210 (USA)		MOTOR	MODELO	SOPORTE	ESPECIFICACIÓN	No. BUFALO
L4	1.3	74 - 77	MOTOR	FRONTAL / DER / IZQ / <i>MOT. 1.3 Y 1.4 LTS.</i>	<b>A2400</b>	
	1.4		MOTOR	FRONTAL / DER / IZQ / <i>MOT. 1.4 Y 1.5 LTS.</i>	<b>PRÓXIMAMENTE</b>	
	1.5	78 - 82	TRANSMISIÓN	STD / <i>MOT. 1.4 Y 1.5 LTS.</i>	<b>879</b>	

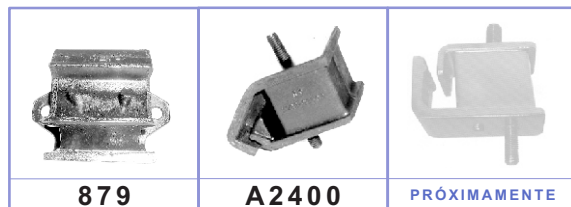



# N I S S A N

---

**AUTOS**

240 SX (USA)	MOTOR	MODELO	SOPORTE	ESPECIFICACIÓN	No. BUFALO
	L4 2.4	89 - 98	MOTOR	FRONTAL / DER	<b>A8810</b>
			MOTOR	FRONTAL / IZQ	<b>A8296</b>

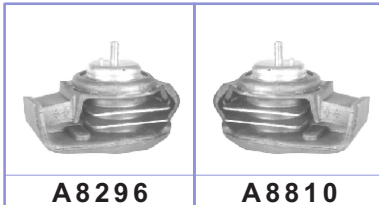

300 ZX (USA)	MOTOR	MODELO	SOPORTE	ESPECIFICACIÓN	No. BUFALO
	V6 3.0	84 - 89	MOTOR	FRONTAL / DER / IZQ / TURBO	<b>A9044</b>



ALTIMA	MOTOR	MODELO	SOPORTE	ESPECIFICACIÓN	No. BUFALO
	L4 2.4	93 - 97	MOTOR	FRONTAL / DER / AUT	<b>A8704</b>
			MOTOR	FRONTAL / IZQ	<b>1045</b>
		93 - 03	MOTOR	FRONTAL / AUT	<b>1045-A</b>
			MOTOR	TRASERO / AUT	<b>1045-B</b>
			TRANSMISIÓN	AUT / REPUESTO A8705	<b>995</b>
			TRANSMISIÓN	AUT	<b>A8705</b>
			MOTOR	TRASERO	<b>980</b>
			97 - 03	MOTOR	FRONTAL / DER / IZQ / DIÁMETRO INTERIOR 1/2"
		TRANSMISIÓN		FRONTAL	<b>1012</b>

L4 2.5	02 - 06	MOTOR	FRONTAL	<b>PRÓXIMAMENTE</b>	
		MOTOR	FRONTAL / DER	<b>A9190</b>	
		MOTOR	TRASERO	<b>A8865</b>	
		MOTOR	FRONTAL / DER	<b>A8866</b>	
		MOTOR	TRASERO	<b>1092</b>	
		TRANSMISIÓN	AUT	<b>A8705</b>	
		07 - 10	MOTOR	FRONTAL / AUT / STD / CTV	<b>PRÓXIMAMENTE</b>
			MOTOR	TORSIÓN / FRONTAL / AUT / STD / CTV	<b>PRÓXIMAMENTE</b>
			MOTOR	TRASERO / AUT / STD / CTV	<b>PRÓXIMAMENTE</b>

V6 3.5	93 - 98	MOTOR	FRONTAL	<b>A2855</b>
		MOTOR	TRASERO / DER	<b>1052</b>
	02 - 06	MOTOR	FRONTAL / AUT / REPUESTO	<b>1052-B</b>
		MOTOR	FRONTAL	<b>1071</b>

CONTINÚA...

ALTIMA		V6 3.5	02 - 06	MOTOR	FRONTAL / AUT	PRÓXIMAMENTE
						MOTOR
				TRANSMISIÓN	AUT	<b>A8705</b>
				TRANSMISIÓN	AUT	PRÓXIMAMENTE
		07 - 10		MOTOR	FRONTAL / DER / AUT / STD / CTV	PRÓXIMAMENTE
				MOTOR	TORSIÓN / FRONTAL / AUT / STD / CTV	PRÓXIMAMENTE
				MOTOR	TRASERO / AUT / STD / CTV	PRÓXIMAMENTE
				MOTOR	AUT / STD / CTV	PRÓXIMAMENTE
				TRANSMISIÓN	AUT / STD / CTV	PRÓXIMAMENTE

**\*VER ANEXO PAG. 214**

<b>980</b>	<b>995</b>	<b>995-A</b>	<b>1012</b>	<b>1023</b>	<b>1045</b>	<b>1045-A</b>
<b>1045-B</b>	<b>1052</b>	<b>1052-B</b>	<b>1071</b>	<b>1092</b>	<b>A2855</b>	<b>A8704</b>
<b>A8705</b>	<b>A8865</b>	<b>A8866</b>	<b>A9190</b>	PRÓXIMAMENTE	PRÓXIMAMENTE	PRÓXIMAMENTE
PRÓXIMAMENTE	PRÓXIMAMENTE	PRÓXIMAMENTE	PRÓXIMAMENTE	PRÓXIMAMENTE	PRÓXIMAMENTE	PRÓXIMAMENTE

ALMERA	MOTOR	MODELO	SOPORTE	ESPECIFICACIÓN	No. BUFALO
L4 1.6	02 - 06	MOTOR	FRONTAL	<b>1041</b>	
		MOTOR	FRONTAL / DER	<b>1044</b>	

<b>1041</b>	<b>1044</b>



# N I S S A N

---

**AUTOS**

APRIO	MOTOR	MODELO	SOPORTE	ESPECIFICACIÓN	No. BUFALO
	L4 1.6	07 - 10	MOTOR	FRONTAL / DER	<b>1129-A</b>
			MOTOR	TORSIÓN / INF	<b>A8392-5Z001</b>
			TRANSMISIÓN	SUPERIOR	<b>A9771</b>



DATSUN SEDAN VAGONETA	MOTOR	MODELO	SOPORTE	ESPECIFICACIÓN	No. BUFALO		
	L4	1500	66 - 74	MOT / TRANSM	FRONTAL / DER	<b>721 Y 723</b>	
			68 - 75	MOTOR	FRONTAL / IZQ	<b>573</b>	
		MOTOR		FRONTAL / DER	<b>574</b>		
		68 - 84	MOTOR	FRONTAL / DER / IZQ	<b>775</b>		
			TRANSMISIÓN		<b>879</b>		
		1600	74 - 78	MOTOR	FRONTAL / DER / IZQ	<b>738</b>	
				MOTOR	SOPORTE METÁLICO / FRONTAL	<b>787</b>	
		1800	74 - 85	TRANSMISIÓN		<b>797</b>	
				79 - 87	MOTOR	FRONTAL / DER / IZQ	<b>775</b>
					MOTOR	FRONTAL / DER / IZQ	<b>864</b>
			MOTOR	FRONTAL / DER / IZQ	<b>A2400</b>		

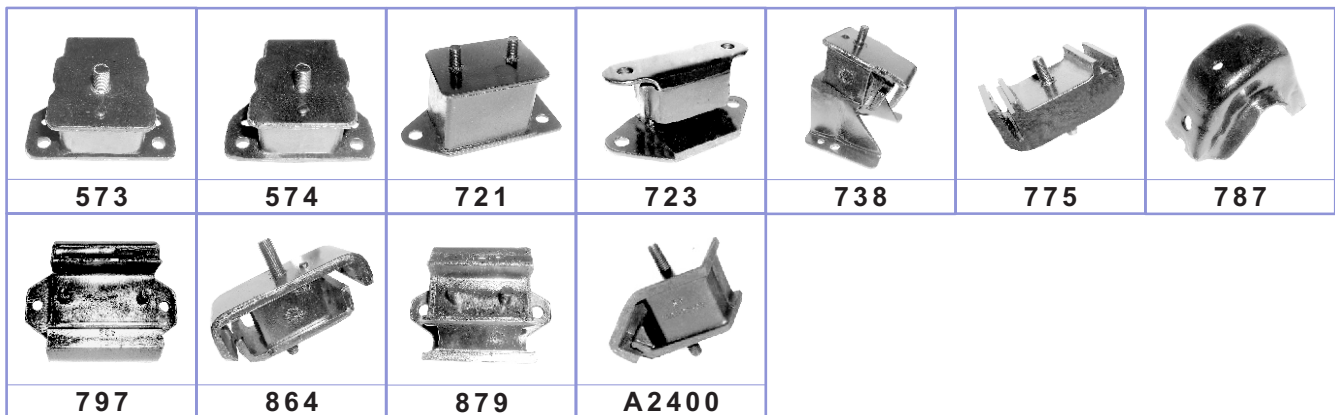

HIKARI	MOTOR	MODELO	SOPORTE	ESPECIFICACIÓN	No. BUFALO
	L4 1.6	84 - 87	TRANSMISIÓN	STD	<b>833</b>
			TRANSMISIÓN	AUT	<b>834</b>
			TRANSMISIÓN		<b>912-A</b>





MAXIMA	MOTOR	MODELO	SOPORTE	ESPECIFICACIÓN	No. BUFALO
L4	2.4	85 - 88	MOTOR	FRONTAL / DER	<b>A 2857</b>
			MOTOR	TRASERO	PRÓXIMAMENTE
			TRANSMISIÓN	STD	<b>A 8604</b>
			TRANSMISIÓN		<b>A 8604</b>
		89 - 94	MOTOR	TRASERO / DER / AUT / SOHC	PRÓXIMAMENTE
			TRANSMISIÓN	STD	PRÓXIMAMENTE
		90 - 95	MOTOR	TRASERO	<b>1045-B</b>
		92 - 94	MOTOR	FRONTAL / DOBLE ÁRBOL DE LEVAS	<b>A 9048</b>
		93 - 97	TRANSMISIÓN	AUT	<b>A 8705</b>
		95 - 99	MOTOR	FRONTAL / AUT / STD	<b>A 8865</b>
		95 - 01	MOTOR	FRONTAL / DER / AUT / STD / REPUESTO A8866	<b>1072</b>
			MOTOR	FRONTAL / DER / AUT / STD	<b>A 9031</b>
			MOTOR	TRASERO / AUT / STD	<b>A 8866</b>
			MOTOR	FRONTAL / DER / IZQ / INTERIOR 1/2"	<b>835-BC</b>
			MOTOR	16 VÁLVULAS	<b>965</b>
		97 - 02	MOTOR	FRONTAL / DER / IZQ	<b>995</b>
			MOTOR	FRONTAL / DER / IZQ / INTERIOR 1/2"	<b>995-A</b>
		97 - 03	TRANSMISIÓN		<b>1012</b>
98 - 03	MOTOR	TRASERO / AUT / STD	<b>980</b>		

V6	3.0	85 - 88	MOTOR	FRONTAL / DER	<b>A 2857</b>
			MOTOR	FRONTAL / 5 VELOCIDADES	<b>A 8962</b>
			MOTOR	TRASERO	PRÓXIMAMENTE
			TRANSMISIÓN	STD	<b>A 8604</b>
			TRANSMISIÓN	AUT	<b>A 8140</b>
			TRANSMISIÓN		<b>A 8604</b>
		89 - 94	MOTOR	TRASERO / DER / SOHC / AUT	PRÓXIMAMENTE
			MOTOR	TRASERO / IZQ / SOHC	<b>A 6341</b>
			MOTOR	TRASERO / IZQ / SOHC	<b>A 8603</b>
			TRANSMISIÓN	STD	PRÓXIMAMENTE
			TRANSMISIÓN	AUT / SOHC	<b>A 8601</b>
		92 - 94	MOTOR	FRONTAL / DOBLE ÁRBOL DE LEVAS	<b>A 9048</b>
		93 - 98	MOTOR		<b>A 2855</b>
		93 - 02	MOTOR	TRASERO	<b>A 2857</b>
		95 - 00	MOTOR	FRONTAL / DER / REPUESTO	<b>A 8865</b>
		95 - 01	MOTOR	FRONTAL / DER (95 - 99 / AUT / STD, 00 - 01 / STD)	<b>1072</b>
			MOTOR	TRASERO (95 - 99 / AUT / STD, 00 - 01 / STD)	<b>A 9031</b>
			MOTOR	STD	<b>A 8866</b>
TRANSMISIÓN	REPUESTO		<b>A 9039</b>		
TRANSMISIÓN	AUT		<b>1072</b>		
95 - 03	TRANSMISIÓN	STD / 5 VELOCIDADES	<b>A 9035</b>		

V6	3.0	00 - 01	MOTOR	FRONTAL / DER / AUT	PRÓXIMAMENTE
		02 - 03	MOTOR	FRONTAL / DER / AUT	<b>A 9031</b>
		02 - 06	MOTOR	FRONTAL / TRASERO	<b>1052</b>
			MOTOR	FRONTAL / DER	<b>A 8866</b>



# N I S S A N

---

## AUTOS

MAXIMA	MOTOR	MODELO	SOPORTE	ESPECIFICACIÓN	No. BUFALO
	V6 3.5	93 - 01	MOTOR	FRONTAL / DER	PRÓXIMAMENTE
			MOTOR	TRASERO / STD	<b>A9048</b>
			TRANSMISIÓN	AUT / REPUESTO	<b>1072</b>
			TRANSMISIÓN	AUT	PRÓXIMAMENTE
			MOTOR	FRONTAL / REPUESTO	<b>1052</b>
			MOTOR	FRONTAL	PRÓXIMAMENTE
			MOTOR	FRONTAL / DER	<b>A9190</b>
			TRANSMISIÓN		PRÓXIMAMENTE
		95 - 01	MOTOR	FRONTAL / DER / AUT / REPUESTO A9031	<b>1072</b>
			MOTOR	FRONTAL / DER / AUT	<b>A9031</b>
		95 - 03	TRANSMISIÓN	FRONTAL / STD / DOCH	<b>A9035</b>
		02 - 06	MOTOR	TRASERO	<b>1052</b>
			MOTOR		<b>1052-B</b>
			MOTOR		<b>1071</b>

						
<b>835-BC</b>	<b>965</b>	<b>980</b>	<b>995</b>	<b>995-A</b>	<b>1012</b>	<b>1045-B</b>
						
<b>1052</b>	<b>1052-B</b>	<b>1071</b>	<b>1072</b>	<b>A2855</b>	<b>A2857</b>	<b>A6341</b>
						
<b>A8140</b>	<b>A8601</b>	<b>A8603</b>	<b>A8604</b>	<b>A8705</b>	<b>A8865</b>	<b>A8866</b>
						
<b>A8962</b>	<b>A9031</b>	<b>A9035</b>	<b>A9048</b>	<b>A9190</b>	PRÓXIMAMENTE	PRÓXIMAMENTE
						
PRÓXIMAMENTE	PRÓXIMAMENTE	PRÓXIMAMENTE	PRÓXIMAMENTE	PRÓXIMAMENTE		



MICRA	MOTOR	MODELO	SOPORTE	ESPECIFICACIÓN	No. BUFALO
L4	1.4	05 - 08	MOTOR	FRONTAL / DER	<b>1129-A</b>
			MOTOR	FRONTAL / IZQ	<b>A8392-5Z001</b>
			MOTOR	TORSIÓN	<b>A9671</b>



NX	MOTOR	MODELO	SOPORTE	ESPECIFICACIÓN	No. BUFALO
L4	1.6	91 - 93	MOTOR	FRONTAL	<b>900</b>
			MOTOR	FRONTAL / REPUESTO	<b>900-R</b>
			MOTOR	FRONTAL / IZQ / REPUESTO	<b>874</b>
			MOTOR	FRONTAL / IZQ	<b>PRÓXIMAMENTE</b>
			MOTOR	FRONTAL / DER / REPUESTO A8122	<b>995</b>
			MOTOR	FRONTAL / DER	<b>8122</b>
			MOTOR	TRASERO / AUT / STD / REPUESTO 932	<b>1012</b>
			MOTOR	TRASERO / AUT / STD	<b>932</b>
			TRANSMISIÓN	AUT	<b>PRÓXIMAMENTE</b>
			TRANSMISIÓN	STD / REPUESTO	<b>874</b>
			TRANSMISIÓN	STD	<b>PRÓXIMAMENTE</b>

L4	2.0	91 - 93	MOTOR	FRONTAL	<b>900</b>
			MOTOR	FRONTAL	<b>900-R</b>
			MOTOR	FRONTAL / DER / AUT / REPUESTO	<b>1052</b>
			MOTOR	FRONTAL / DER / AUT	<b>PRÓXIMAMENTE</b>
			MOTOR	FRONTAL / DER / STD / REPUESTO	<b>874</b>
			MOTOR	FRONTAL / DER / STD	<b>PRÓXIMAMENTE</b>
			MOTOR	TRASERO / AUT / STD / REPUESTO 932	<b>1012</b>
			MOTOR	TRASERO / AUT / STD	<b>932</b>







L4	2.0	91 - 93	TRANSMISIÓN	STD / REPUESTO	<b>874</b>
			TRANSMISIÓN	STD	<b>PRÓXIMAMENTE</b>
			TRANSMISIÓN	AUT	<b>PRÓXIMAMENTE</b>





# N I S S A N

**AUTOS**

NX						
	<b>1052</b>	<b>A8122</b>	PRÓXIMAMENTE	PRÓXIMAMENTE	PRÓXIMAMENTE	PRÓXIMAMENTE
						
	PRÓXIMAMENTE					

PLATINA	MOTOR	MODELO	SOPORTE	ESPECIFICACIÓN	No. BUFALO
L4	1.6	02 - 09	MOTOR	FRONTAL / DER	<b>1018</b>
			MOTOR	FRONTAL / DER	<b>1018-C</b>
			MOTOR	TORSIÓN / TRASERO / STD / <i>REPUESTO 1023-C</i>	<b>1023</b>
			MOTOR	TORSIÓN / TRASERO / STD	<b>1023-C</b>
			MOTOR	TORSIÓN / TRASERO / AUT	<b>A1792</b>
			TRANSMISIÓN	STD	<b>1037</b>
			TRANSMISIÓN	AUT	PRÓXIMAMENTE

						
<b>1018</b>	<b>1018-C</b>	<b>1023</b>	<b>1023-C</b>	<b>1037</b>	<b>A1792</b>	PRÓXIMAMENTE

SAMURAI	MOTOR	MODELO	SOPORTE	ESPECIFICACIÓN	No. BUFALO
L4		84 - 87	TRANSMISIÓN	STD	<b>833</b>
			TRANSMISIÓN	AUT	<b>834</b>
			TRANSMISIÓN		<b>912-A</b>

		
<b>833</b>	<b>834</b>	<b>912-A</b>

# CALIDAD Y GARANTÍA

SENTRA	MOTOR	MODELO	SOPORTE	ESPECIFICACIÓN	No. BUFALO
L4	1.8	91 - 94	MOTOR	FRONTAL	<b>1041</b>
			MOTOR	FRONTAL / DER / AUT / STD	<b>1044</b>
			MOTOR	TRASERO	<b>1012</b>
			TRANSMISIÓN		<b>1045</b>
			MOTOR	TRASERO	<b>1072</b>
			TRANSMISIÓN	AUT	PRÓXIMAMENTE
			TRANSMISIÓN	STD	PRÓXIMAMENTE
			MOTOR	FRONTAL / DER	PRÓXIMAMENTE
			MOTOR	FRONTAL / DER	<b>1063</b>
			MOTOR	FRONTAL / DER	<b>1063R</b>

L4	2.0	96 - 06	MOTOR	FRONTAL	<b>1041</b>
			MOTOR	FRONTAL / DER / REPUESTO	<b>965</b>
			MOTOR	FRONTAL / DER	<b>A8122</b>
			MOTOR	TRASERO / AUT / STD / REPUESTO 932	<b>1012</b>
			MOTOR	TRASERO / AUT / STD	<b>932</b>
			MOTOR	TRASERO / AUT / STD / REPUESTO 932	<b>932-R</b>
			MOTOR	TRASERO / DER	<b>1045-A</b>
			TRANSMISIÓN	TRASERO	<b>995</b>
			MOTOR	FRONTAL / DER	<b>1063</b>
			MOTOR	FRONTAL / DER	<b>1063R</b>
		98 - 03	MOTOR	TRASERO	<b>A8701</b>
			MOTOR	TRASERO	<b>995</b>
			MOTOR	TRASERO	<b>980</b>
		07 - 11	MOTOR	FRONTAL / DER	<b>1129-A</b>
			MOTOR	TORSIÓN / INFERIOR / TRASERO	<b>A8392-5Z001</b>
			TRANSMISIÓN		PRÓXIMAMENTE

L4	2.4	02 - 06	MOTOR	FRONTAL / IZQ	<b>1045</b>
----	-----	---------	-------	---------------	-------------

<b>932</b>	<b>932-R</b>	<b>965</b>	<b>980</b>	<b>995</b>	<b>1012</b>	<b>1041</b>
<b>1044</b>	<b>1045</b>	<b>1045-A</b>	<b>1063</b>	<b>1063R</b>	<b>1072</b>	<b>1129-A</b>
<b>A8122</b>	<b>A8705</b>	<b>A83692-5Z001</b>	PRÓXIMAMENTE	PRÓXIMAMENTE	PRÓXIMAMENTE	PRÓXIMAMENTE



# NISSAN

**AUTOS**

SENTRA SE-R	MOTOR	MODELO	SOPORTE	ESPECIFICACIÓN	No. BUFALO
L4 2.5	02 - 06	MOTOR	MOTOR	FRONTAL	<b>1041</b>
		MOTOR	MOTOR	FRONTAL / DER	PRÓXIMAMENTE
		MOTOR	MOTOR	TRASERO	<b>1012</b>
		MOTOR	MOTOR	TRASERO	<b>1045-A</b>
		TRANSMISIÓN		AUT / REPUESTO	<b>1072</b>
		TRANSMISIÓN		AUT	PRÓXIMAMENTE
		TRANSMISIÓN		STD	PRÓXIMAMENTE



STANZA	MOTOR	MODELO	SOPORTE	ESPECIFICACIÓN	No. BUFALO	
L4	2.0	82 - 86	MOTOR	TRASERO	PRÓXIMAMENTE	
			MOTOR	TORSIÓN / FRONTAL	PRÓXIMAMENTE	
			TRANSMISIÓN	STD	PRÓXIMAMENTE	
	2.4	87 - 89	MOTOR	MOTOR	FRONTAL / DER / MOT. 2.4 LTS.	<b>A7311</b>
			MOTOR	MOTOR	TORSIÓN / FRONTAL	PRÓXIMAMENTE
			MOTOR	MOTOR	TORSIÓN / FRONTAL / AUT	<b>A8137</b>
			MOTOR	MOTOR	FRONTAL / 5 VEL. / MOT. 2.4 LTS.	<b>A8874</b>



TIIDA	MOTOR	MODELO	SOPORTE	ESPECIFICACIÓN	No. BUFALO
L4 1.8	06 - 11	MOTOR	MOTOR	FRONTAL / DER	PRÓXIMAMENTE
		MOTOR	MOTOR	FRONTAL / SUPERIOR / DER	<b>1132-A</b>
		MOTOR	MOTOR	TORSIÓN / INFERIOR	<b>A8392-5Z001</b>
		TRANSMISIÓN		SUPERIOR	<b>A9771</b>
L4 2.0	06 - 07	MOTOR		TRASERO	<b>A9671</b>



TSURU I	MOTOR	MODELO	SOPORTE	ESPECIFICACIÓN	No. BUFALO
L4 1.6	84 - 87		MOTOR	FRONTAL / DER / <i>REPUESTO</i>	<b>832</b>
			MOTOR	FRONTAL / DER	<b>PRÓXIMAMENTE</b>
			MOTOR	TORSIÓN / FRONTAL / INFERIOR / <i>REPUESTO 803</i>	<b>803-R</b>
			MOTOR	TORSIÓN / FRONTAL / INFERIOR	<b>803</b>
			MOTOR	TORSIÓN / FRONTAL / INFERIOR	<b>829-R</b>
			MOTOR	TORSIÓN / FRONTAL / INFERIOR	<b>829</b>
			TRANSMISIÓN	AUT / STD	<b>833</b>
			PALANCA	CAJA DE VELOCIDADES	<b>942</b>

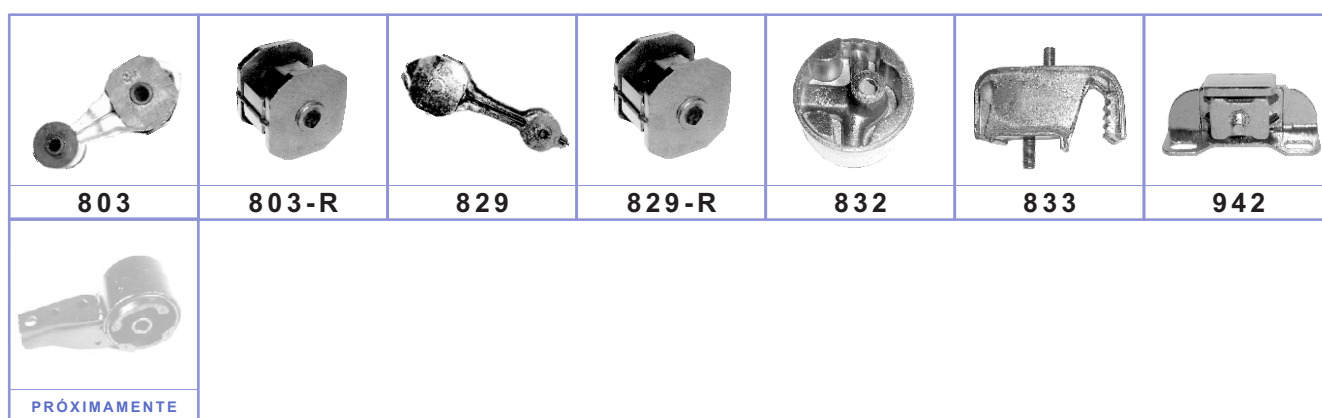

TSURU II SENTRA (USA)	MOTOR	MODELO	SOPORTE	ESPECIFICACIÓN	No. BUFALO	
L4	L4 / L6	70 - 83	MOTOR	FRONTAL / DER IZQ	<b>A2401</b>	
			TRANSMISIÓN	STD	<b>833</b>	
		1600	84 - 87	TRANSMISIÓN	AUT	<b>834</b>
				MOTOR	FRONTAL / DER	<b>PRÓXIMAMENTE</b>
		1800	88 - 91	MOTOR	FRONTAL / DER / <i>REPUESTO</i>	<b>835</b>
				MOTOR	FRONTAL / <i>REFORZADO</i>	<b>835</b>
				MOTOR	FRONTAL / DER / IZQ	<b>832</b>
				MOTOR	TORSIÓN / FRONTAL / INFERIOR	<b>827</b>
				MOTOR	TORSIÓN / TRASERA / INFERIOR	<b>827-A</b>
				MOTOR	TORSIÓN / TRASERA / INFERIOR / <i>REP. 827 Y 827-A</i>	<b>827-R</b>
				PALANCA	CAJA DE VELOCIDADES	<b>1000</b>
		1600	89 - 90	PALANCA	FRONTAL / DER	<b>PRÓXIMAMENTE</b>
				MOTOR	TRASERO	<b>835-A</b>
PALANCA	CAJA DE VELOCIDADES			<b>943</b>		
1800	91	MOTOR	FRONTAL / DER / IZQ	<b>835</b>		











# N I S S A N

---

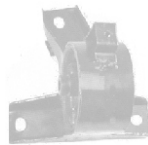
**AUTOS**

<b>TSURU II SENTRA (USA)</b>						
	<b>835-A</b>	<b>943</b>	<b>1000</b>	<b>A2401</b>	<b>PROXIMAMENTE</b>	<b>PROXIMAMENTE</b>

<b>TSURU III TSUBAME</b>	MOTOR	MODELO	SOPORTE	ESPECIFICACIÓN	No. BUFALO			
<b>L4</b>		<b>92 - 01</b>	MOTOR	FRONTAL / IZQ / DIÁMETRO INTERIOR 3/8"	<b>835-B</b>			
			MOTOR	FRONTAL / DER / IZQ	<b>874</b>			
			MOTOR	FRONTAL / INF / REPUESTO 900	<b>900-R</b>			
			MOTOR	FRONTAL / INF	<b>900</b>			
			MOTOR	FRONTAL / DER / REPUESTO	<b>835</b>			
			MOTOR	FRONTAL / DER	<b>PRÓXIMAMENTE</b>			
		<b>92 - 10</b>	<b>1.6</b>	<b>2.0</b>	MOTOR	FRONTAL / DER / REPUESTO	<b>965</b>	
					TRANSMISIÓN	FRONTAL / DER / 16 VÁLVULAS	<b>A8122</b>	
					PALANCA	TRASERO / REPUESTO 932	<b>932-R</b>	
					MOTOR	TRASERO	<b>932</b>	
					TRANSMISIÓN	IZQ / REPUESTO	<b>835</b>	
					TRANSMISIÓN	IZQ	<b>PRÓXIMAMENTE</b>	
				<b>2.0</b>	<b>92 - 10</b>	TRANSMISIÓN	TRASERA / REPUESTO	<b>835-A</b>
						TRANSMISIÓN	REPUESTO	<b>835</b>
						TRANSMISIÓN	STD	<b>PRÓXIMAMENTE</b>
						TRANSMISIÓN	AUT	<b>PRÓXIMAMENTE</b>
						PALANCA	CAJA DE VELOCIDAD	<b>1025</b>
						PALANCA	CAJA DE VELOCIDAD	<b>943</b>

						
<b>835</b>	<b>835-A</b>	<b>835-B</b>	<b>874</b>	<b>900</b>	<b>900-R</b>	<b>932</b>
						
<b>932-R</b>	<b>943</b>	<b>965</b>	<b>1025</b>	<b>A8122</b>	<b>PRÓXIMAMENTE</b>	<b>PRÓXIMAMENTE</b>
						
<b>PRÓXIMAMENTE</b>						

# N I S S A N

**TODO TERRENO**



MR

ARMADA	MOTOR	MODELO	SOPORTE	ESPECIFICACIÓN	No. BUFALO
	V8 5.6	04 - 09	MOTOR	FRONTAL / DER / IZQ	PRÓXIMAMENTE
			TRANSMISIÓN	TRACCIÓN TRASERA	PRÓXIMAMENTE
			TRANSMISIÓN	4 X 4	PRÓXIMAMENTE



MURANO	MOTOR	MODELO	SOPORTE	ESPECIFICACIÓN	No. BUFALO
	V6 3.5	02 - 06	MOTOR	TRASERO / DER	1052
			MOTOR		1052-B
			MOTOR	FRONTAL / DER	A9190
			MOTOR		1071
		03 - 10	MOTOR	FRONTAL / REPUESTO	995
			MOTOR	FRONTAL / TRACCIÓN DELANTERA	PRÓXIMAMENTE
			MOTOR	4 X 4	PRÓXIMAMENTE
			MOTOR	FRONTAL / DER / 4 X 4	A9190
			MOTOR	TRASERO / REPUESTO	995
			MOTOR	TRASERO / 4 X 4	PRÓXIMAMENTE
			MOTOR		PRÓXIMAMENTE
			TRANSMISIÓN	AUT / 4 VEL	A8705
			TRANSMISIÓN	AUT / 5 VEL	PRÓXIMAMENTE

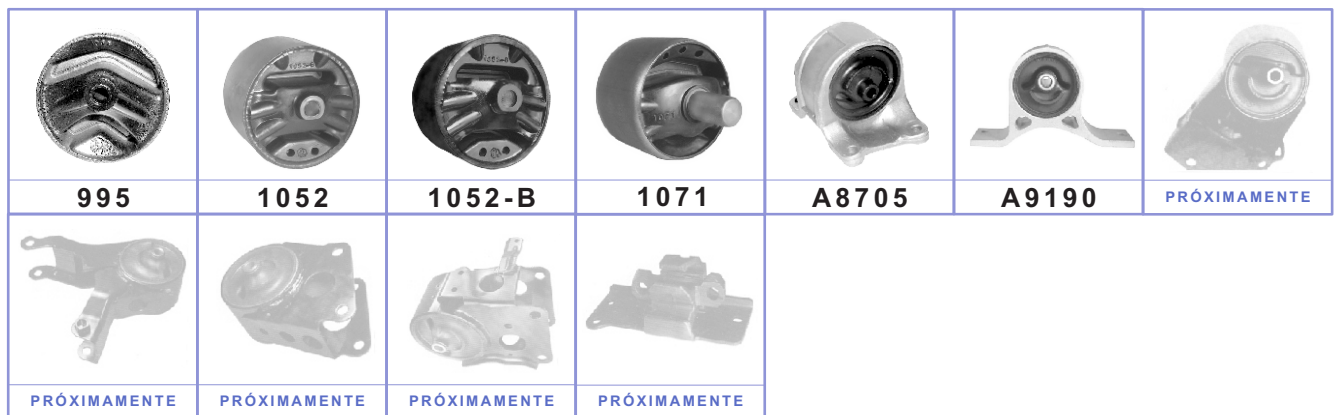

**CALIDAD Y GARANTÍA**

**Autopartes Hule - Metal**



# NISSAN

**TODO TERRENO**

PATHFINDER		MOTOR	MODELO	SOPORTE	ESPECIFICACIÓN	No. BUFALO
L4	2.4	87 - 89	MOTOR	FRONTAL / DER / IZQ	895	
			TRANSMISIÓN		A8124	
V6	3.0	87 - 95	MOTOR	FRONTAL / DER / IZQ	A8114	
			TRANSMISIÓN	4 X 4	A8124	
			TRANSMISIÓN	TRACCIÓN TRASERA	797	
V6	3.3	96 - 00	MOTOR	FRONTAL / DER / IZQ / 4WD	A8311	
			TRANSMISIÓN	TRACCIÓN TRASERA	999	
		97 - 00	TRANSMISIÓN	STD / 4 X 4	PRÓXIMAMENTE	
			TRANSMISIÓN	AUT / TRACCIÓN TRASERA / 4WD	A9038	
V6	3.5	01 - 04	MOTOR	FRONTAL / DER / IZQ	A8311	
			TRANSMISIÓN	STD / 4 X 4	PRÓXIMAMENTE	
			TRANSMISIÓN	TRACCIÓN TRASERA	999	
			TRANSMISIÓN	AUT / 4 X 4	A9038	

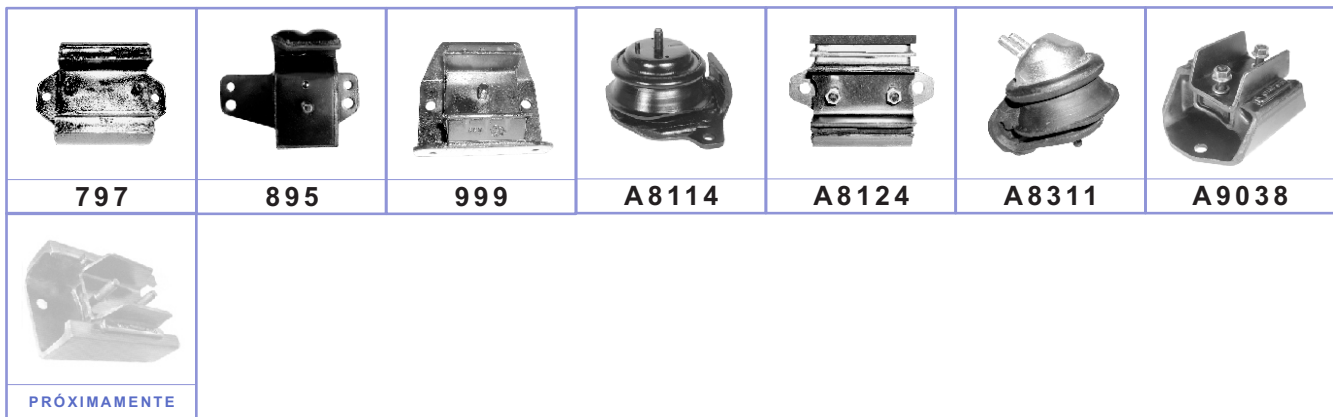

X-TERRA		MOTOR	MODELO	SOPORTE	ESPECIFICACIÓN	No. BUFALO
L4	2.4	00 - 04	MOTOR	FRONTAL / IZQ	895	
			MOTOR	FRONTAL / DER	895	
			TRANSMISIÓN		797	
			TRANSMISIÓN	4 X 4	A8124	
			MOTOR	FRONTAL / IZQ	A9012	
V6	3.3	00 - 04	MOTOR	FRONTAL / IZQ / DER	A8311	
			TRANSMISIÓN	TRACCIÓN TRASERA	797	
			TRANSMISIÓN	4 X 4	A8124	

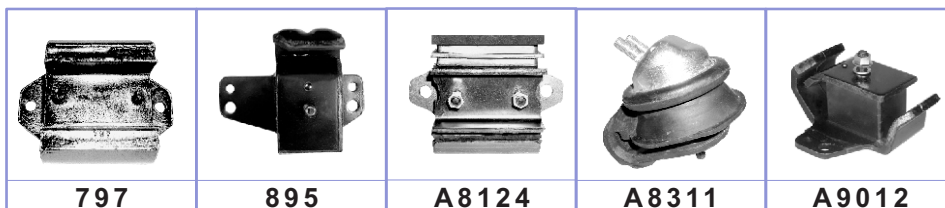









# N I S S A N

**TODO TERRENO**



X-TRAIL	MOTOR	MODELO	SOPORTE	ESPECIFICACIÓN	No. <i>BUFALO</i>
	L4 2.5	02 - 07	MOTOR	FRONTAL	PRÓXIMAMENTE
			MOTOR	FRONTAL / DER	PRÓXIMAMENTE
			MOTOR	TRASERO	PRÓXIMAMENTE
			MOTOR	TRASERO / REPUESTO	<b>1121-A</b>
			TRANSMISIÓN	REPUESTO	<b>1072</b>
			TRANSMISIÓN		PRÓXIMAMENTE

					
<b>1072</b>	<b>1121-A</b>	PRÓXIMAMENTE	PRÓXIMAMENTE	PRÓXIMAMENTE	PRÓXIMAMENTE



## CALIDAD Y GARANTÍA DE EXPORTACIÓN



# N I S S A N

PICK UP

DATSUN (MEX) NISSAN (MEX)		MOTOR	MODELO	SOPORTE	ESPECIFICACIÓN	No. BUFALO
L4	1500	75 - 92	MOTOR	MOTOR	FRONTAL / DER	<b>916-A</b>
			MOTOR	MOTOR	FRONTAL / IZQ	PRÓXIMAMENTE
			TRANSMISIÓN			<b>912-A</b>
L4	1800	83 - 93	MOTOR	MOTOR	FRONTAL / DER	<b>865</b>
			MOTOR	MOTOR	FRONTAL / IZQ	<b>799</b>

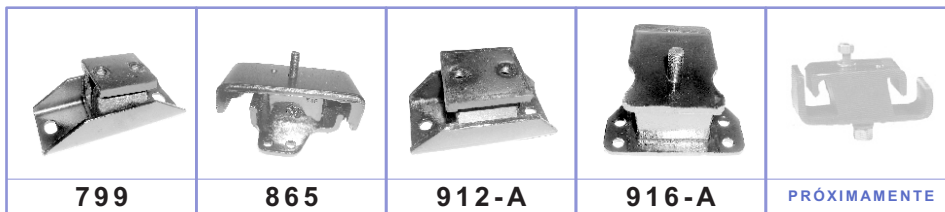

FRONTER		MOTOR	MODELO	SOPORTE	ESPECIFICACIÓN	No. BUFALO
L4	2.4	98 - 04	MOTOR	MOTOR	FRONTAL / IZQ	<b>895</b>
			MOTOR	MOTOR	FRONTAL / DER	<b>895</b>
			TRANSMISIÓN		TRACCIÓN TRASERA	<b>797</b>
			TRANSMISIÓN		4 X 4	<b>A8124</b>
	08	MOTOR	MOTOR	FRONTAL / DER / IZQ	<b>895</b>	
		TRANSMISIÓN		4 X 2	PRÓXIMAMENTE	
		TRANSMISIÓN		4 X 4	<b>A8124</b>	
		MOTOR	MOTOR	FRONTAL / IZQ	<b>A9012</b>	
V6	3.3	99 - 04	MOTOR	MOTOR	FRONTAL / DER / IZQ	<b>A8311</b>
			TRANSMISIÓN		TRACCIÓN TRASERA / 4 X 4	<b>A8124</b>
V6	3.5	08 - 10	MOTOR	MOTOR	FRONTAL / DER / IZQ	PRÓXIMAMENTE
			TRANSMISIÓN		4 X 2	PRÓXIMAMENTE
			TRANSMISIÓN		4 X 4	PRÓXIMAMENTE



PICK UP / D21	MOTOR	MODELO	SOPORTE	ESPECIFICACIÓN	No. BUFALO
L4 2.4		75 - 93	MOTOR	FRONTAL / DER / IZQ	916-A
		83 - 93	MOTOR	FRONTAL / DER / IZQ	865
		93 - 10	MOTOR	FRONTAL / DER / IZQ	895
			TRANSMISIÓN		797
		94 - 00	TRANSMISIÓN		879

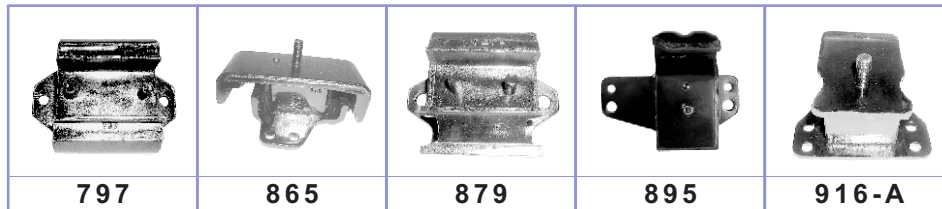

PICK UP (USA)	MOTOR	MODELO	SOPORTE	ESPECIFICACIÓN	No. BUFALO
L-16 1.6 L-18 1.8		70 - 74	TRANSMISIÓN		912-A
L-20 2.0		75 - 79	MOTOR	FRONTAL / DER	A8114
			TRANSMISIÓN		912-A
L-24 2.4		83 - 86	MOTOR	FRONTAL / DER / IZQ	865
			TRANSMISIÓN		912-A
L4 2.4		86 - 97	MOTOR	FRONTAL / DER / IZQ / 4 X 4	PRÓXIMAMENTE
			TRANSMISIÓN	4 X 4	A8124
		93 - 08	MOTOR	FRONTAL / DER / IZQ / TRACCIÓN TRASERA	895
			TRANSMISIÓN	TRACCIÓN TRASERA	797
V6 3.0		86 - 96	MOTOR	FRONTAL / DER / IZQ / 4 X 4 / TRACCIÓN TRASERA	916-A
			TRANSMISIÓN	4 X 4	A8124
			TRANSMISIÓN	TRACCIÓN TRASERA	797

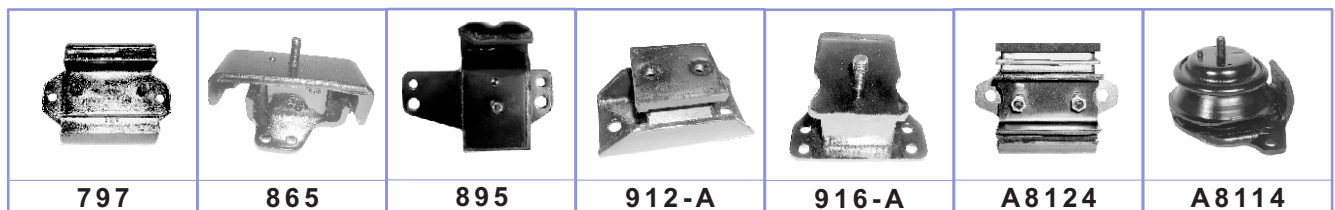



# N I S S A N

PICK UP

PICK UP D22 DIESEL	MOTOR	MODELO	SOPORTE	ESPECIFICACIÓN	No. BUFALO
	L4 2.4	08 - 10	MOTOR	FRONTAL / DER	PRÓXIMAMENTE
			TRANSMISIÓN	FRONTAL / IZQ	PRÓXIMAMENTE
			TRANSMISIÓN	DER / IZQ	PRÓXIMAMENTE



PRÓXIMAMENTE PRÓXIMAMENTE PRÓXIMAMENTE

TITAN	MOTOR	MODELO	SOPORTE	ESPECIFICACIÓN	No. BUFALO
	V8 5.6	04 - 10	MOTOR	FRONTAL / DER / IZQ	PRÓXIMAMENTE
			TRANSMISIÓN	TRACCIÓN TRASERA	PRÓXIMAMENTE
			TRANSMISIÓN	4 X 4	PRÓXIMAMENTE



PRÓXIMAMENTE PRÓXIMAMENTE PRÓXIMAMENTE

# N I S S A N

CAMIONETAS VAN

AXXESS	MOTOR	MODELO	SOPORTE	ESPECIFICACIÓN	No. BUFALO
	L4 2.4	90 - 95	MOTOR	TRASERO	1045-B
			MOTOR	TORSIÓN / FRONTAL	PRÓXIMAMENTE
			MOTOR	TORSIÓN / FRONTAL	A8874



1045-B A8874 PRÓXIMAMENTE

QUEST	MOTOR	MODELO	SOPORTE	ESPECIFICACIÓN	No. BUFALO
V6	3.0	93 - 05	MOTOR	FRONTAL / DER / IZQ / INTERIOR 1/2"	<b>835-BC</b>
			MOTOR	FRONTAL / DER / IZQ / REPUESTO A2855	<b>932-R</b>
			MOTOR	FRONTAL / DER / IZQ	<b>A2855</b>
			MOTOR	FRONTAL / IZQ	<b>A2856</b>
			MOTOR	FRONTAL / IZQ / REPUESTO A2856	<b>1076</b>
			MOTOR	TRASERO / DER	<b>A2857</b>
			TRANSMISIÓN		<b>A2854</b>
			TRANSMISIÓN	REPUESTO A2854	<b>1077</b>
V6	3.3	99 - 03	MOTOR	FRONTAL / REPUESTO A2989	<b>932-R</b>
			MOTOR	FRONTAL	<b>A2989</b>
			MOTOR	TRASERO / IZQ	<b>PRÓXIMAMENTE</b>
			MOTOR	TRASERO / DER	<b>A2857</b>
			TRANSMISIÓN		<b>A2854</b>
V6	3.5	04 - 10	MOTOR	FRONTAL / REPUESTO	<b>1052-B</b>
			MOTOR	FRONTAL	<b>PRÓXIMAMENTE</b>
			MOTOR	FRONTAL / DER	<b>A9190</b>
			MOTOR	TRASERO / REPUESTO	<b>1052-B</b>
			MOTOR	TRASERO / AUT / 5 VEL	<b>PRÓXIMAMENTE</b>
			TRANSMISIÓN	AUT / 4 VEL	<b>A8705</b>
			TRANSMISIÓN	AUT / 5 VEL	<b>PRÓXIMAMENTE</b>

<b>835-BC</b>	<b>932-R</b>	<b>1052-B</b>	<b>1076</b>	<b>1077</b>	<b>A2854</b>	<b>A2855</b>
<b>A2856</b>	<b>A2857</b>	<b>A2989</b>	<b>A8705</b>	<b>A9190</b>	<b>PRÓXIMAMENTE</b>	<b>PRÓXIMAMENTE</b>
<b>PRÓXIMAMENTE</b>	<b>PRÓXIMAMENTE</b>					



# N I S S A N

## CAMIONETAS VAN

URVAN	MOTOR	MODELO	SOPORTE	ESPECIFICACIÓN	No. BUFALO
L4 2.4		99 - 02	MOTOR	FRONTAL / DER / IZQ	1026
			TRANSMISIÓN		999
		03 - 10	MOTOR	FRONTAL / IZQ	1027-A
			MOTOR	FRONTAL / DER	1027
			TRANSMISIÓN		1083



ICHI VAN	MOTOR	MODELO	SOPORTE	ESPECIFICACIÓN	No. BUFALO
L4		87 - 94	TRANSMISIÓN		797-A

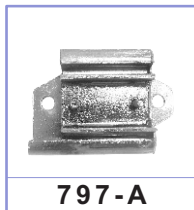

# \* ANEXOS

## AUTOS

ALTIMA	MOTOR	MODELO	SOPORTE	ESPECIFICACIÓN	No. BUFALO
V6 3.5		07 - 10	TRANSMISIÓN		A1789-B
			TRANSMISIÓN	FRONTAL / DER / IZQ	1112-A

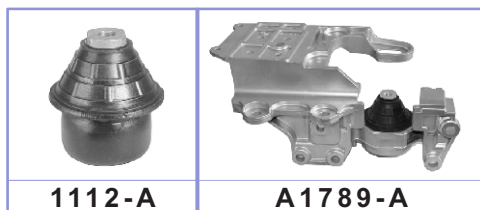

206 D-SING 206 X-LINE 206 XR 206 XS FELINE	MOTOR	MODELO	SOPORTE	ESPECIFICACIÓN	No. BUFALO
	L4 1.4 1.6	03 - 09	MOTOR	FRONTAL / MOT. 1.4 LTS	<b>1056</b>
			MOTOR	FRONTAL / DER	PRÓXIMAMENTE
			MOTOR	CENTRAL	<b>1058</b>
			MOTOR	TRASERO /AUT	<b>1059</b>
			MOTOR	TRASERO / FLECHA / REPUESTO	<b>1058-A</b>
			MOTOR	TRASERO / FLECHA / REPUESTO	PRÓXIMAMENTE
			TRANSMISIÓN	SUPERIOR	<b>A1511</b>
			MOTOR	JUEGO	<b>A206-C</b>

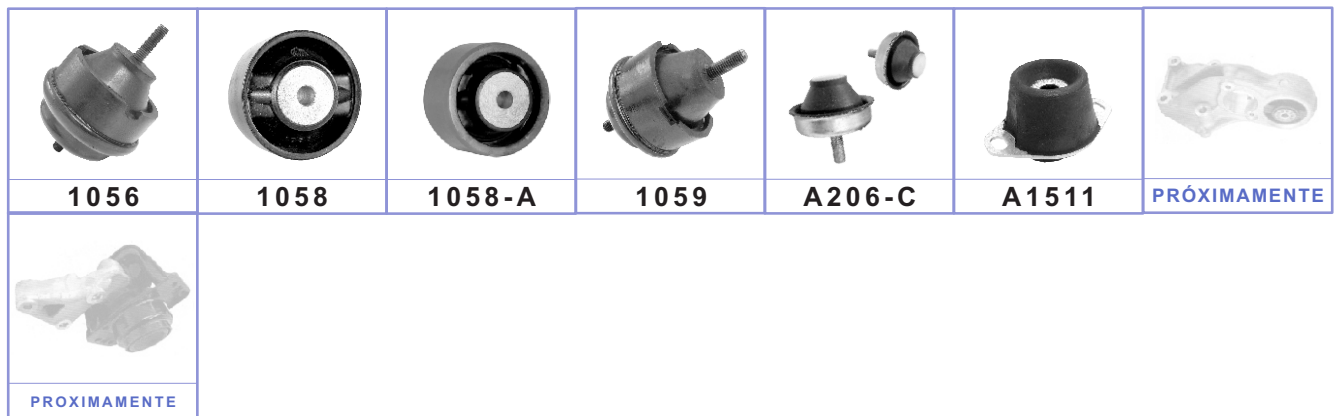

207 COMPACT 207 SEDAN	MOTOR	MODELO	SOPORTE	ESPECIFICACIÓN	No. BUFALO
	L4 1.4 1.6	09 - 11	MOTOR	FRONTAL	<b>1056</b>
			MOTOR	FRONTAL / DER / MOT. 1.6 LTS.	PRÓXIMAMENTE
			MOTOR	CENTRAL	<b>1058</b>
			MOTOR	TRASERO	<b>1059</b>
			MOTOR	TRASERO / FLECHA / REPUESTO	<b>1058-A</b>
			MOTOR	TRASERO / FLECHA / APLICA COMPACT / REPUESTO	PRÓXIMAMENTE
			TRANSMISIÓN	TRASERO / FLECHA / APLICA SEDAN / REPUESTO	PRÓXIMAMENTE
TRANSMISIÓN			SUPERIOR	<b>A1511</b>	

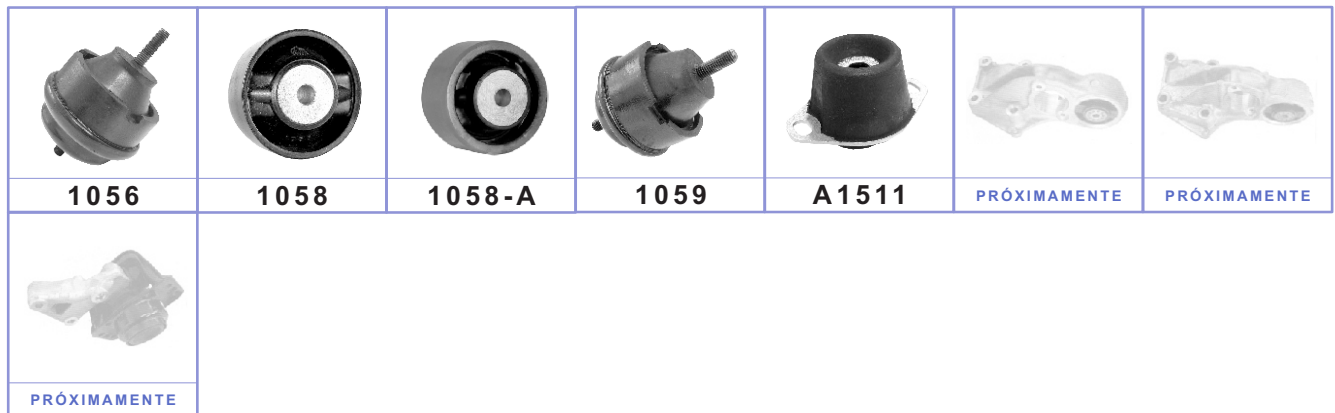



# PEUGEOT

**AUTOS**

207 COMPACT 207 SEDAN	MOTOR	MODELO	SOPORTE	ESPECIFICACIÓN	No. BUFALO
L4	1.4	03 - 11	MOTOR	FRONTAL / DER	<b>1056</b>
			MOTOR	FRONTAL / DER / MOT. 1.6 LTS.	PRÓXIMAMENTE
			MOTOR	TRASERO	<b>1059</b>
			MOTOR	TRASERO / FLECHA / REPUESTO	<b>1058-A</b>
			MOTOR	TRASERO / FLECHA / APLICA A COMPACT / REPUESTO	PRÓXIMAMENTE
			MOTOR	TRASERO / FLECHA / APLICA A SEDÁN / REPUESTO	PRÓXIMAMENTE
	TRANSMISIÓN	SUPERIOR	<b>A1511</b>		



306	MOTOR	MODELO	SOPORTE	ESPECIFICACIÓN	No. BUFALO
L4	1.6	03 - 11	MOTOR	FRONTAL / DER	<b>1056</b>



307 307 SEDAN	MOTOR	MODELO	SOPORTE	ESPECIFICACIÓN	No. BUFALO
L4	2.0	03 - 11	MOTOR	FRONTAL / DER	<b>1056</b>
			MOTOR	FRONTAL / DER	PRÓXIMAMENTE
			MOTOR	FRONTAL / DER	<b>1058-A</b>
			MOTOR	TRASERO / FLECHA / REPUESTO	<b>1058</b>
			MOTOR	TRASERO / FLECHA / STD / REPUESTO	PRÓXIMAMENTE
			MOTOR	TRASERO / FLECHA / REPUESTO	<b>1059</b>
			MOTOR	TRASERO / FLECHA / AUT / REPUESTO	PRÓXIMAMENTE
			TRANSMISIÓN	SUPERIOR	<b>A2794</b>





# PEUGEOT

**AUTOS**



PARTNER / PARTNER GRAND RAID	MOTOR	MODELO	SOPORTE	ESPECIFICACIÓN	No. <i>BUFALO</i>
	L4 1.6	06 - 07	MOTOR	FRONTAL	<b>1056</b>
			MOTOR	FRONTAL / IZQ	<b>A1511</b>
			MOTOR	TRASERO	<b>1059</b>
			MOTOR	CENTRAL	<b>1058</b>
			TRANSMISIÓN	FLECHA / STD	<b>PRÓXIMAMENTE</b>
					<b>A2794</b>

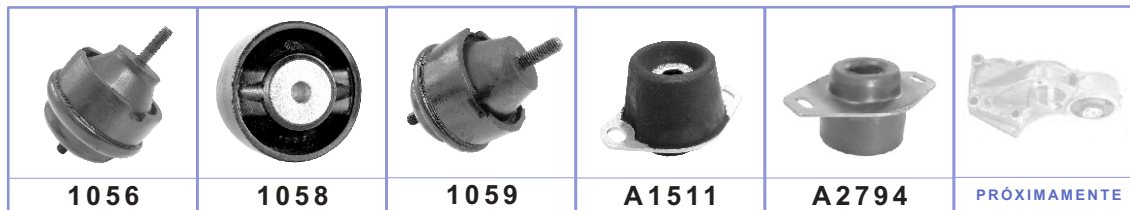

# RAMBLER

**AUTOS**

RAMBLER RALLY GREMLIN VAN RAMBLER	MOTOR	MODELO	SOPORTE	ESPECIFICACIÓN	No. <i>BUFALO</i>	
	4 CIL		63 - 74	MOTOR	FRONTAL / DER / IZQ	<b>546</b>
			64 - 72	TRANSMISIÓN	FRONTAL / DER / STD	<b>5193</b>
			69 - 72	TRANSMISIÓN	STD / AUT	<b>5188</b>
	6 CIL		73 - 76	TRANSMISIÓN	STD / AUT	<b>709</b>
				TRANSMISIÓN	STD	<b>720</b>
			73 - 83	TRANSMISIÓN	STD / AUT	<b>732</b>
				MOTOR	STD / AUT	<b>768</b>
	77 - 85	TRANSMISIÓN		<b>821</b>		

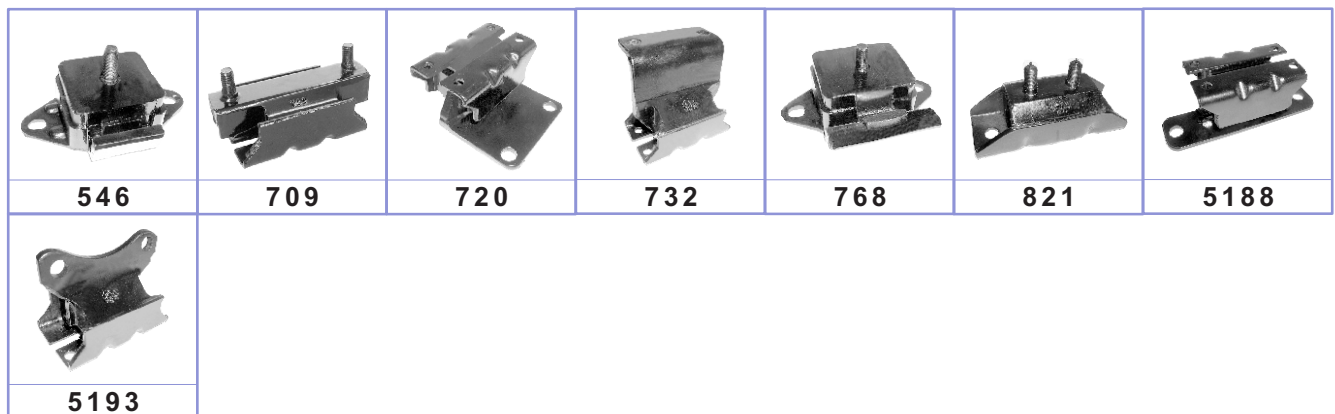

# CALIDAD Y GARANTÍA



# RENAULT

**AUTOS**

ALIANCE ANCORE	MOTOR	MODELO	SOPORTE	ESPECIFICACIÓN	No. BUFALO
	L4		MOTOR	FRONTAL / DER	<b>906-A</b>
			MOTOR	FRONTAL / IZQ	<b>907-A</b>

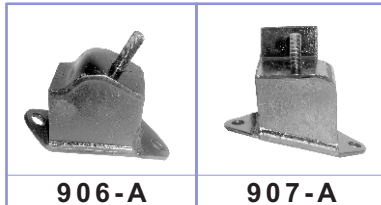

CLIO KANGOO	MOTOR	MODELO	SOPORTE	ESPECIFICACIÓN	No. BUFALO	
	L4	1.6	03 - 10	MOTOR	FRONTAL / DER	<b>1018</b>
				MOTOR	FRONTAL / DER	<b>1018-C</b>
				MOTOR	FRONTAL / SUPERIOR	PRÓXIMAMENTE
				MOTOR	TORSIÓN / INFERIOR / REPUESTO	<b>1023</b>
				MOTOR	TORSIÓN / INFERIOR / STD	<b>1023-C</b>
				MOTOR	TORSIÓN / INFERIOR / AUT	<b>A1792</b>
				TRANSMISIÓN	STD	<b>1037</b>
				TRANSMISIÓN		<b>1039</b>
TRANSMISIÓN	AUT	PRÓXIMAMENTE				



LAGUNA	MOTOR	MODELO	SOPORTE	ESPECIFICACIÓN	No. BUFALO	
	V6	3.0	03 - 06	MOTOR	TORSIÓN / INFERIOR	<b>A4089</b>
				MOTOR	TRASERO	<b>A4309</b>

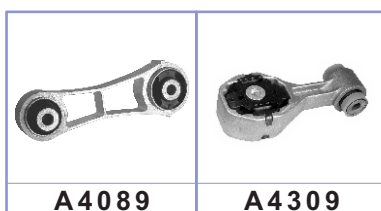

MEGANE SCENIC	MOTOR	MODELO	SOPORTE	ESPECIFICACIÓN	No. BUFALO
	L4 2.0	01 - 04	MOTOR	FRONTAL / DER	<b>1018</b>
			MOTOR	FRONTAL / DER	<b>1018-C</b>
			MOTOR	FRONTAL / DER / HIDRÁULICO	<b>1030</b>
			MOTOR	TORSIÓN / SUPERIOR	<b>PRÓXIMAMENTE</b>
			MOTOR	TORSIÓN / INFERIOR / STD	<b>A1792</b>
			MOTOR	TORSIÓN / INFERIOR / AUT	<b>A1774</b>
			TRANSMISIÓN	AUT	<b>A7286</b>



MEGANE II SCENIC II	MOTOR	MODELO	SOPORTE	ESPECIFICACIÓN	No. BUFALO
	L4 2.0	05 - 09	MOTOR	FRONTAL	<b>1129-A</b>
			MOTOR	TORSIÓN / SUPERIOR / STD	<b>PRÓXIMAMENTE</b>
			MOTOR	TORSIÓN / INFERIOR / AUT	<b>1130-A</b>
TRANSMISIÓN	STD / AUT	<b>PRÓXIMAMENTE</b>			



R-5 M1300, M1400TX	MOTOR	MODELO	SOPORTE	ESPECIFICACIÓN	No. BUFALO
	4 CIL	75 - 84	MOTOR	FRONTAL / IZQ	<b>744</b>
			MOTOR	FRONTAL / DER	<b>745</b>
TRANSMISIÓN				<b>746</b>	

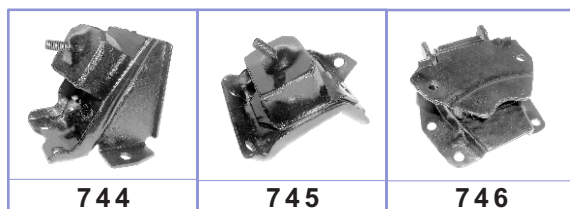



R-12 M1100, M1300	MOTOR	MODELO	SOPORTE	ESPECIFICACIÓN	No. BUFALO
	4 CIL	74 - 84	TRANSMISIÓN		<b>730</b>
			MOTOR	FRONTAL / DER / IZQ	<b>731</b>



# RENAULT

AUTOS

R-12 M1100, M1300		
	730	731

R-18 M1600, M1800	MOTOR	MODELO	SOPORTE	ESPECIFICACIÓN	No. BUFALO
	4 CIL	80 - 85	TRANSMISIÓN		
MOTOR				FRONTAL / DER / IZQ / MOT. 2.0	782
MOTOR				FRONTAL / DER / IZQ	786

		
778	782	786

# SEAT

AUTOS

CORDOBA / IBIZA	MOTOR	MODELO	SOPORTE	ESPECIFICACIÓN	No. BUFALO
	L4 1.6	00 - 02	MOTOR		FRONTAL
MOTOR				FRONTAL / DER	989
TRANSMISIÓN				STD	848
TRANSMISIÓN				AUT	848
BASE					841/273C
TRANSMISIÓN					848-A
L4 1.6 2.0	03 - 08	MOTOR		FRONTAL / DER	A1670
		MOTOR		TORSIÓN / TRASERA	PRÓXIMAMENTE
		TRANSMISIÓN			PRÓXIMAMENTE

						
848	848-A	988	989	A1670	841/273C	PRÓXIMAMENTE

PRÓXIMAMENTE

# S E A T

AUTOS



MR

LEÓN/ TOLEDO	MOTOR	MODELO	SOPORTE	ESPECIFICACIÓN	No. BUFALO
L4	1.8	00 - 06	MOTOR	FRONTAL / DER	<b>A 199-262</b>
			MOTOR	FRONTAL / IZQ	<b>A 199-555</b>
	2.0		MOTOR	TORSIÓN / TRASERO	<b>A 199-851</b>
			TRANSMISIÓN		<b>848-A</b>

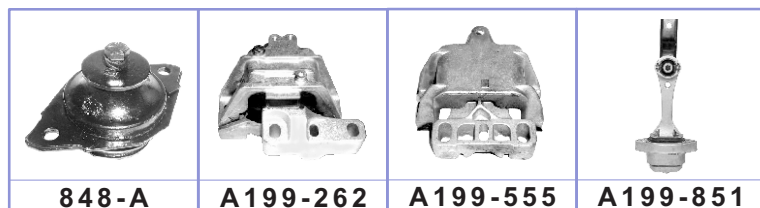

LEÓN	MOTOR	MODELO	SOPORTE	ESPECIFICACIÓN	No. BUFALO
L4	2.0	07 - 10	MOTOR	FRONTAL / DER	<b>PRÓXIMAMENTE</b>
			MOTOR	CENTRAL / SUPERIOR	<b>PRÓXIMAMENTE</b>
			MOTOR	CENTRAL / INFERIOR	<b>PRÓXIMAMENTE</b>
			MOTOR	TORSIÓN / CENTRAL	<b>A 105-C</b>
			TRANSMISIÓN		<b>A 1172</b>
			TRANSMISIÓN		<b>A 1272</b>

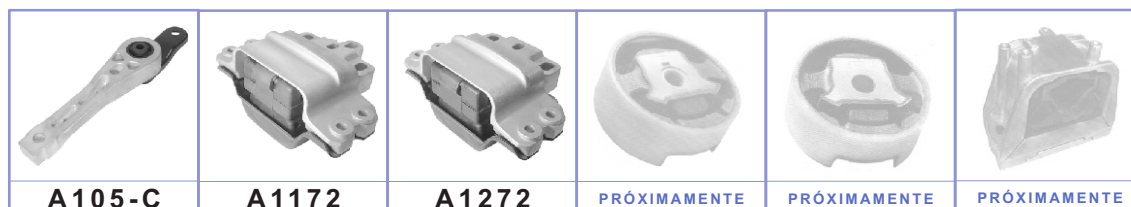

# S U B A R U

AUTOS

LEXUS RX 300	MOTOR	MODELO	SOPORTE	ESPECIFICACIÓN	No. BUFALO
V6	3.0	99 - 03	MOTOR	FRONTAL	<b>A 8995</b>
					<b>A 8690</b>

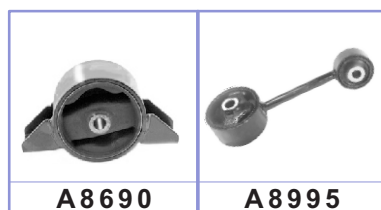



**S U Z U K I**  
AUTOS

AERO	MOTOR	MODELO	SOPORTE	ESPECIFICACIÓN	No. BUFALO
L4	2.0	02 - 06	TRANSMISIÓN	AUT	A9177
	2.3	04 - 06	MOTOR	FRONTAL / DER	A9156

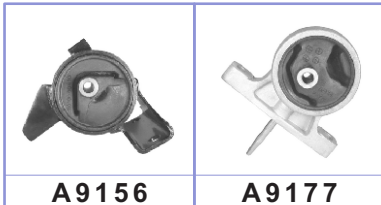

SA 310	MOTOR	MODELO	SOPORTE	ESPECIFICACIÓN	No. BUFALO
L3	1.0	85	MOTOR	FRONTAL / STD	PRÓXIMAMENTE
			MOTOR	FRONTAL / IZQ	PRÓXIMAMENTE
			MOTOR	TORSIÓN / TRASERO	A8568



SWIFT	MOTOR	MODELO	SOPORTE	ESPECIFICACIÓN	No. BUFALO
L3	1.0	92 - 94	MOTOR	FRONTAL	PRÓXIMAMENTE
			TRANSMISIÓN	FRONTAL / IZQ	PRÓXIMAMENTE
L3	1.3	89 - 94	MOTOR	TORSIÓN / TRASERO	PRÓXIMAMENTE
		89 - 01	MOTOR	FRONTAL	PRÓXIMAMENTE
			TRANSMISIÓN	FRONTAL	PRÓXIMAMENTE



**CALIDAD Y GARANTÍA  
DE EXPORTACIÓN**

GRAND VITARA	MOTOR	MODELO	SOPORTE	ESPECIFICACIÓN	No. BUFALO
V6	2.5	99 - 05	MOTOR	FRONTAL / DER / IZQ	<b>1115-A</b>
	2.7		TRANSMISIÓN		PRÓXIMAMENTE

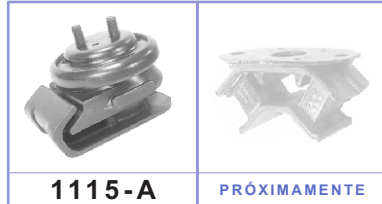

**1115-A**

PRÓXIMAMENTE

SAMURAI	MOTOR	MODELO	SOPORTE	ESPECIFICACIÓN	No. BUFALO
L4	1.3	85 - 95	MOTOR	FRONTAL / IZQ	PRÓXIMAMENTE



PRÓXIMAMENTE

SIDE KICK	MOTOR	MODELO	SOPORTE	ESPECIFICACIÓN	No. BUFALO
L4	1.3	89	MOTOR	FRONTAL / DER / IZQ	<b>A8161</b>
			TRANSMISIÓN	IZQ	PRÓXIMAMENTE
L4	1.6	89 - 90	MOTOR	FRONTAL / DER / IZQ	<b>A8568</b>
		89 - 98	MOTOR	TORSIÓN / FRONTAL	PRÓXIMAMENTE
			TRANSMISIÓN	IZQ	PRÓXIMAMENTE
91 - 98	MOTOR	FRONTAL / DER / IZQ	PRÓXIMAMENTE		
L4	1.8	96 - 98	MOTOR	FRONTAL / DER / IZQ	<b>1115-A</b>
			TRANSMISIÓN		PRÓXIMAMENTE

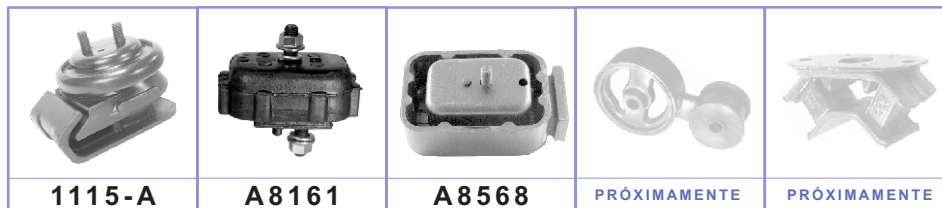

**1115-A**

**A8161**

**A8568**

PRÓXIMAMENTE

PRÓXIMAMENTE

VITARA	MOTOR	MODELO	SOPORTE	ESPECIFICACIÓN	No. BUFALO
L4	1.6	99 - 04	MOTOR	FRONTAL / DER / IZQ	<b>1115-A</b>
	2.0		TRANSMISIÓN		PRÓXIMAMENTE



**S U Z U K I**



**TODO TERRENO**

<b>VITARA</b>		
	<b>1115-A</b>	<b>PRÓXIMAMENTE</b>

<b>X-90</b>	<b>MOTOR</b>	<b>MODELO</b>	<b>SOPORTE</b>	<b>ESPECIFICACIÓN</b>	<b>No. BUFALO</b>
	<b>L4</b> 1.6	<b>96 - 98</b>	MOTOR	FRONTAL / DER / IZQ/ 4 X 4	<b>A 8 5 6 8</b>
			MOTOR	FRONTAL / DER / IZQ	<b>PRÓXIMAMENTE</b>
			TRANSMISIÓN	IZQ	<b>PRÓXIMAMENTE</b>

		
<b>A 8 5 6 8</b>	<b>PRÓXIMAMENTE</b>	<b>PRÓXIMAMENTE</b>

<b>XL-7</b>	<b>MOTOR</b>	<b>MODELO</b>	<b>SOPORTE</b>	<b>ESPECIFICACIÓN</b>	<b>No. BUFALO</b>
	<b>L4</b> 2.2	<b>01 - 02</b>	TRANSMISIÓN		<b>PRÓXIMAMENTE</b>
		<b>02 - 06</b>	MOTOR	FRONTAL / DER / IZQ	<b>1115-A</b>

	
<b>1115-A</b>	<b>PRÓXIMAMENTE</b>

**CALIDAD Y GARANTÍA  
EXPORTACIÓN**



AVALON	MOTOR	MODELO	SOPORTE	ESPECIFICACIÓN	No. BUFALO
V6 3.0	95 - 96		MOTOR	FRONTAL	PROXIMAMENTE
			MOTOR	TRASERO	PROXIMAMENTE
			MOTOR	TORSIÓN / FRONTAL / DER	PROXIMAMENTE
	95 - 04		TRANSMISIÓN		PROXIMAMENTE
	97 - 99		MOTOR	TRASERO	<b>A 8699</b>
			MOTOR	TORSIÓN / FRONTAL / DER	<b>A 8995</b>
	98 - 99		MOTOR	FRONTAL	PROXIMAMENTE
	05 - 06		TRANSMISIÓN		PROXIMAMENTE

<b>A8699</b>	<b>A8995</b>	PROXIMAMENTE	PROXIMAMENTE	PROXIMAMENTE	PROXIMAMENTE	PROXIMAMENTE
PROXIMAMENTE						

CAMRY	MOTOR	MODELO	SOPORTE	ESPECIFICACIÓN	No. BUFALO
L4 2.0	83 - 86		MOTOR	FRONTAL / STD	<b>A 2677</b>
			MOTOR	TRASERO / AUT / STD	PROXIMAMENTE
			TRANSMISIÓN	FRONTAL	PROXIMAMENTE
			TRANSMISIÓN		<b>A 9053</b>
	87 - 88		TRANSMISIÓN	STD	PROXIMAMENTE
	87 - 91		MOTOR	FRONTAL / DER	<b>A 8196</b>
			TRANSMISIÓN	CENTRAL	<b>A 8208</b>
	87 - 92		MOTOR	FRONTAL / AUT / TRACCIÓN DELANTERA	<b>A 8193</b>
			MOTOR	TRASERA / STD / TRACCIÓN DELANTERA	PROXIMAMENTE
			MOTOR	FRONTAL / AUT / TRACCIÓN DELANTERA	PROXIMAMENTE
	88 - 92		MOTOR	FRONTAL / AUT	<b>A 8192</b>
			MOTOR	FRONTAL / DER / TRACCIÓN DELANTERA	<b>A 8207</b>

L4 2.2	92 - 96		MOTOR	FRONTAL	PROXIMAMENTE
			MOTOR	TRASERO	PROXIMAMENTE
	92 - 01		MOTOR	TORSIÓN / FRONTAL / DER	<b>A 8199</b>
			MOTOR		<b>A 8796HY</b>
			TRANSMISIÓN	TRASERO	PROXIMAMENTE
			TRANSMISIÓN	TORSIÓN / FRONTAL / DER	<b>A 8979</b>
	97 - 01		MOTOR	FRONTAL	PROXIMAMENTE

L4 2.4	02 - 09		MOTOR	FRONTAL	PROXIMAMENTE
			MOTOR	TORSIÓN / FORNTAL	PROXIMAMENTE

CONTINUA...



# TOYOTA

**AUTOS**

CAMRY	MOTOR	MODELO	SOPORTE	ESPECIFICACIÓN	No. BUFALO
L4	2.4	02 - 09	MOTOR	TORSIÓN / TRASERO	PRÓXIMAMENTE
			TRANSMISIÓN		PRÓXIMAMENTE
V6	2.5	88 - 92	MOTOR	FRONTAL / STD	<b>A 8192</b>
			MOTOR	FRONTAL / AUT	<b>A 8193</b>
			MOTOR	TRASERO / AUT	PRÓXIMAMENTE
			TRANSMISIÓN		<b>A 8208</b>
V6	3.0	92	TRANSMISIÓN	STD	PRÓXIMAMENTE
		92 - 93	TRANSMISIÓN		<b>A 8529</b>
		92 - 96	MOTOR	TRASERO / AUT / STD	PRÓXIMAMENTE
			MOTOR	TORSIÓN / FRONTAL / DER	PRÓXIMAMENTE
		93	TRANSMISIÓN	STD	PRÓXIMAMENTE
		94 - 96	MOTOR	FRONTAL	PRÓXIMAMENTE
			TRANSMISIÓN	AUT / STD	PRÓXIMAMENTE
		97 - 01	MOTOR	FRONTAL	PRÓXIMAMENTE
			MOTOR	TRASERO / AUT	<b>A 8699</b>
		97 - 01	MOTOR	TORSIÓN / FRONTAL / DER / AUT	PRÓXIMAMENTE
			MOTOR	TORSIÓN / FRONTAL / DER / STD	PRÓXIMAMENTE
		97 - 01	TRANSMISIÓN	STD	PRÓXIMAMENTE
			TRANSMISIÓN	AUT	PRÓXIMAMENTE
		97 - 02	MOTOR	TRASERO / STD	PRÓXIMAMENTE
		02 - 06	MOTOR	TORSIÓN / FRONTAL / DER / AUT	<b>A 8979</b>
TRANSMISIÓN			PRÓXIMAMENTE		
V6	3.3	04 - 07	MOTOR	TORSIÓN / FRONTAL / DER	PRÓXIMAMENTE
			TRANSMISIÓN		PRÓXIMAMENTE
	3.5	07 - 09	TRANSMISIÓN		PRÓXIMAMENTE

<b>A 2677</b>	<b>A 8192</b>	<b>A 8193</b>	<b>A 8196</b>	<b>A 8199</b>	<b>A 8207</b>	<b>A 8208</b>
<b>A 8529</b>	<b>A 8699</b>	<b>A 8796HY</b>	<b>A 8979</b>	<b>A 9053</b>	PRÓXIMAMENTE	PRÓXIMAMENTE
PRÓXIMAMENTE	PRÓXIMAMENTE	PRÓXIMAMENTE	PRÓXIMAMENTE	PRÓXIMAMENTE	PRÓXIMAMENTE	PRÓXIMAMENTE

CONTINÚA...

<b>CAMRY</b>						
	PRÓXIMAMENTE	PRÓXIMAMENTE	PRÓXIMAMENTE	PRÓXIMAMENTE	PRÓXIMAMENTE	PRÓXIMAMENTE
PRÓXIMAMENTE	PRÓXIMAMENTE	PRÓXIMAMENTE	PRÓXIMAMENTE	PRÓXIMAMENTE	PRÓXIMAMENTE	

<b>CELICA</b>		MOTOR	MODELO	SOPORTE	ESPECIFICACIÓN	No. <b>BUFALO</b>
<b>L4</b>	1.6	<b>90 - 93</b>	MOTOR	FRONTAL / AUT	<b>PRÓXIMAMENTE</b>	
			MOTOR	FRONTAL / STD	<b>PRÓXIMAMENTE</b>	
			MOTOR	FRONTAL / STD	<b>PRÓXIMAMENTE</b>	
<b>L4</b>	1.8	<b>94 - 97</b>	MOTOR	TRASERO / AUT	<b>PRÓXIMAMENTE</b>	
<b>L4</b>	2.0	<b>72 - 74</b>	TRANSMISIÓN	AUT	<b>A 2410</b>	
			TRANSMISIÓN	STD	<b>A 2409</b>	
		<b>83 - 86</b>	MOTOR	FRONTAL	<b>A 2677</b>	
		<b>86 - 89</b>		TRASERO / AUT	<b>A 8407</b>	
<b>L4</b>	2.2	<b>75 - 80</b>	MOTOR	FRONTAL / DER / IZQ	<b>971-A</b>	
			TRANSMISIÓN		<b>A 2410</b>	
		<b>90 - 93</b>	MOTOR	FRONTAL / AUT	<b>PRÓXIMAMENTE</b>	
			MOTOR	FRONTAL / STD	<b>A 8193</b>	
<b>L4</b>	2.4	<b>81</b>	MOTOR	FRONTAL / DER / IZQ	<b>971-A</b>	
			TRANSMISIÓN		<b>A 2410</b>	
		<b>81 - 85</b>	TRANSMISIÓN	FRONTAL	<b>A 8193</b>	
		<b>82 - 85</b>	MOTOR	FRONTAL / DER / IZQ	<b>PRÓXIMAMENTE</b>	
<b>L6</b>	2.8	<b>81</b>	TRANSMISIÓN	FRONTAL / AUT	<b>A 2690</b>	
			<b>82 - 85</b>	TRANSMISIÓN	FRONTAL / STD	<b>A 2690</b>

<b>971-A</b>	<b>A2409</b>	<b>A2410</b>	<b>A2677</b>	<b>A2690</b>	<b>A8193</b>	<b>A8407</b>



MR

# TOYOTA

**AUTOS**

## CELICA



COROLLA	MOTOR	MODELO	SOPORTE	ESPECIFICACIÓN	No. BUFALO
L4	1.2	69 - 79	MOTOR	FRONTAL / DER	PRÓXIMAMENTE
			TRANSMISIÓN		PRÓXIMAMENTE

L4	1.6	71 - 76	TRANSMISIÓN	AUT	<b>A 2690</b>
			MOTOR	FRONTAL / DER / IZQ	PRÓXIMAMENTE
		71 - 79	TRANSMISIÓN	STD	<b>A 2409</b>
			MOTOR	FRONTAL / TRACCIÓN DELANTERA	<b>A 2674</b>
		84 - 87	MOTOR	TRASERO / AUT	PRÓXIMAMENTE
			MOTOR	TRASERO / STD	PRÓXIMAMENTE
			TRANSMISIÓN		<b>A 8214</b>
		88	MOTOR	TRASERO / AUT / 3 VEL / ÁRBOL DE LAVAS SENCILLO	<b>A 8186</b>
			MOTOR	TRASERO / AUT / 4 VEL / ÁRBOL DE LAVAS SENCILLO	PRÓXIMAMENTE
		88 - 89	MOTOR	FRONTAL / DER / TRACCIÓN DELANTERA	PRÓXIMAMENTE
		88 - 92	MOTOR	STD	PRÓXIMAMENTE
			MOTOR	AUT	PRÓXIMAMENTE
			MOTOR	TRASERO / DOBLE ÁRBOL DE LEVAS	PRÓXIMAMENTE
			TRANSMISIÓN	AUT / 3 Y 4 VEL / STD / 5 VEL	PRÓXIMAMENTE
			TRANSMISIÓN	AUT / 4 VEL	PRÓXIMAMENTE
			TRANSMISIÓN	CENTRAL / STD	PRÓXIMAMENTE
			MOTOR	FRONTAL	<b>A 8180</b>
		93 - 07	MOTOR	FRONTAL	<b>A 8181</b>
			MOTOR	FRONTAL / STD	PRÓXIMAMENTE
			MOTOR	FRONTAL / AUT	<b>A 8177</b>
MOTOR	FRONTAL / DER		<b>A 8178</b>		
MOTOR	TRASERO / AUT		PRÓXIMAMENTE		
MOTOR	TRASERO / STD		PRÓXIMAMENTE		
L4	1.8	80 - 82	TRANSMISIÓN	STD	<b>1057</b>
			TRANSMISIÓN	AUT	<b>A 2410</b>
		84 - 85	MOTOR	TRASERO	PRÓXIMAMENTE
		93 - 87	MOTOR	FRONTAL / AUT	<b>A 8177</b>
			MOTOR	FRONTAL / STD	PRÓXIMAMENTE
			MOTOR	FRONTAL / DER	<b>A 8178</b>
			MOTOR	TRASERO / AUT	PRÓXIMAMENTE
			MOTOR	TRASERO / STD	PRÓXIMAMENTE
		TRANSMISIÓN	STD	PRÓXIMAMENTE	
		98 - 02	MOTOR	FRONTAL / STD	<b>A 8177</b>
MOTOR	TRASERO / AUT		<b>A 8179</b>		

COROLLA		MOTOR	MODELO	SOPORTE	ESPECIFICACIÓN	No. BUFALO
L4	1.8	06 - 10	MOTOR	FRONTAL	PRÓXIMAMENTE	
			MOTOR	FRONTAL / DER	PRÓXIMAMENTE	
			MOTOR	TRASERO	PRÓXIMAMENTE	
			TRANSMISIÓN		PRÓXIMAMENTE	
			MOTOR		PRÓXIMAMENTE	
L4	2.4	09	MOTOR	TORSIÓN / TRASERO	PRÓXIMAMENTE	
			TRANSMISIÓN	IZQ	PRÓXIMAMENTE	
			TRANSMISIÓN		PRÓXIMAMENTE	

<b>1057</b>	<b>A2409</b>	<b>A2410</b>	<b>A2674</b>	<b>A2690</b>	<b>A8177</b>	<b>A8178</b>
<b>A8179</b>	<b>A8180</b>	<b>A8181</b>	<b>A8186</b>	<b>A8214</b>	PRÓXIMAMENTE	PRÓXIMAMENTE
PRÓXIMAMENTE	PRÓXIMAMENTE	PRÓXIMAMENTE	PRÓXIMAMENTE	PRÓXIMAMENTE	PRÓXIMAMENTE	PRÓXIMAMENTE
PRÓXIMAMENTE	PRÓXIMAMENTE	PRÓXIMAMENTE	PRÓXIMAMENTE	PRÓXIMAMENTE	PRÓXIMAMENTE	PRÓXIMAMENTE
PRÓXIMAMENTE	PRÓXIMAMENTE	PRÓXIMAMENTE	PRÓXIMAMENTE	PRÓXIMAMENTE	PRÓXIMAMENTE	PRÓXIMAMENTE

# CALIDAD Y GARANTÍA



# TOYOTA

**AUTOS**

CORONA	MOTOR	MODELO	SOPORTE	ESPECIFICACIÓN	No. BUFALO
L4	2.0	72 - 74	TRANSMISIÓN	STD / MOT. 2.0	<b>A2409</b>
			MOTOR	FRONTAL / DER / IZQ	<b>971-A</b>
	2.2	72 - 82	TRANSMISIÓN		<b>A2410</b>
			MOTOR		



CRESSIDA	MOTOR	MODELO	SOPORTE	ESPECIFICACIÓN	No. BUFALO
L6		80 - 84	MOTOR	FRONTAL / STD	<b>A2690</b>
		99 - 92	TRANSMISIÓN	FRONTAL / DER / IZQ	<b>A8344</b>



ECHO	MOTOR	MODELO	SOPORTE	ESPECIFICACIÓN	No. BUFALO
L4	1.5	99 - 05	MOTOR	FRONTAL / DER	<b>PRÓXIMAMENTE</b>
			TRANSMISIÓN		<b>PRÓXIMAMENTE</b>



MATRIX	MOTOR	MODELO	SOPORTE	ESPECIFICACIÓN	No. BUFALO
L4	1.8	02 - 09	MOTOR	TORSIÓN / TRASERO	<b>PRÓXIMAMENTE</b>
			MOTOR	FRONTAL	<b>PRÓXIMAMENTE</b>
		06 - 10	MOTOR	FRONTAL / DER	<b>PRÓXIMAMENTE</b>
			MOTOR	TRASERO	<b>PRÓXIMAMENTE</b>
			TRANSMISIÓN		<b>PRÓXIMAMENTE</b>
			TRANSMISIÓN		<b>PRÓXIMAMENTE</b>



MR-2	MOTOR	MODELO	SOPORTE	ESPECIFICACIÓN	No. BUFALO
	L4 1.6	84 - 86	MOTOR	TRASERO / AUT	<b>A 2685</b>



**A2685**

PASEO	MOTOR	MODELO	SOPORTE	ESPECIFICACIÓN	No. BUFALO
	L4 1.5	92 - 95	TRANSMISIÓN	STD	PRÓXIMAMENTE
		92 - 99	MOTOR	FRONTAL / DER / AUT	PRÓXIMAMENTE
		96 - 99	TRANSMISIÓN	STD	PRÓXIMAMENTE



SOLARA	MOTOR	MODELO	SOPORTE	ESPECIFICACIÓN	No. BUFALO
	L4 2.2	99 - 01	MOTOR	FRONTAL / STD	<b>A 8199</b>
			MOTOR	TRASERO / AUT / COUPE	PRÓXIMAMENTE
			MOTOR	TORSIÓN / FRONTAL / DER / AUT	PRÓXIMAMENTE
			TRANSMISIÓN	STD	<b>A 8199</b>
			TRANSMISIÓN	AUT	<b>A 8979</b>

L4 2.4	04 - 08	MOTOR	FRONTAL	PRÓXIMAMENTE
		MOTOR	TORSIÓN / TRASERO	PRÓXIMAMENTE
		TRANSMISIÓN		PRÓXIMAMENTE

V6 3.0	99 - 03	MOTOR	FRONTAL / AUT	PRÓXIMAMENTE
		MOTOR	TRASERO / AUT	<b>A 8699</b>
		MOTOR	TRASERA / STD	PRÓXIMAMENTE
		MOTOR	TORSIÓN / FRONTAL / DER / AUT	PRÓXIMAMENTE
		MOTOR	TORSIÓN / FRONTAL / DER / STD	PRÓXIMAMENTE
		TRANSMISIÓN	STD	<b>A 8529</b>
		TRANSMISIÓN	AUT	PRÓXIMAMENTE

V6 3.3	04 - 08	MOTOR	TORSIÓN / FRONTAL / DER	PRÓXIMAMENTE
		TRANSMISIÓN		PRÓXIMAMENTE



# TOYOTA

**AUTOS**

<b>SOLARA</b>						
	<b>A8199</b>	<b>A8529</b>	<b>A8699</b>	<b>A8979</b>	PRÓXIMAMENTE	PRÓXIMAMENTE
	PRÓXIMAMENTE	PRÓXIMAMENTE	PRÓXIMAMENTE	PRÓXIMAMENTE	PRÓXIMAMENTE	PRÓXIMAMENTE
	PRÓXIMAMENTE					

<b>TERCEL</b>	MOTOR	MODELO	SOPORTE	ESPECIFICACIÓN	No. BUFALO
<b>L4</b>	1.5	<b>83 - 86</b>	TRANSMISIÓN	AUT / STD / TRACCIÓN DELANTERA	<b>A2685</b>
			TRANSMISIÓN	STD	PRÓXIMAMENTE
		<b>87 - 90</b>	MOTOR	TRASERO	<b>A8173</b>
			MOTOR	FRONTAL / DER	<b>A8278</b>
		<b>91 - 94</b>	TRANSMISIÓN	AUT	PRÓXIMAMENTE
			TRANSMISIÓN	STD	PRÓXIMAMENTE
		<b>91 - 99</b>	MOTOR	AUT / 4 VEL	PRÓXIMAMENTE
			TRANSMISIÓN	AUT	PRÓXIMAMENTE
		<b>95 - 99</b>	TRANSMISIÓN	STD	PRÓXIMAMENTE

<b>A2685</b>	<b>A8173</b>	<b>A8278</b>	PRÓXIMAMENTE	PRÓXIMAMENTE	PRÓXIMAMENTE	PRÓXIMAMENTE
PRÓXIMAMENTE	PRÓXIMAMENTE					

<b>YARIS</b>	MOTOR	MODELO	SOPORTE	ESPECIFICACIÓN	No. BUFALO
<b>L4</b>	1.3	<b>99 - 05</b>	MOTOR	FRONTAL / DER	PRÓXIMAMENTE
			MOTOR	TRASERO	PRÓXIMAMENTE
			TRANSMISIÓN		PRÓXIMAMENTE

CONTINÚA...



YARIS		MOTOR	MODELO	SOPORTE	ESPECIFICACIÓN	No. BUFALO
L4	1.5	06 - 11	MOTOR	FRONTAL / DER	PRÓXIMAMENTE	
			MOTOR	TORSIÓN / TRASERO / AUT	PRÓXIMAMENTE	
			MOTOR	TORSIÓN / TRASERO / STD	PRÓXIMAMENTE	
			TRANSMISIÓN	REPUESTO	PRÓXIMAMENTE	
			TRANSMISIÓN	REPUESTO	PRÓXIMAMENTE	



HIGHLANDER		MOTOR	MODELO	SOPORTE	ESPECIFICACIÓN	No. BUFALO
L4	2.4	01 - 07	TRANSMISIÓN		PRÓXIMAMENTE	
V6	3.0	01 - 03	TRANSMISIÓN		PRÓXIMAMENTE	
V6	3.3	04 - 09	TRANSMISIÓN		PRÓXIMAMENTE	



4 RUNNER		MOTOR	MODELO	SOPORTE	ESPECIFICACIÓN	No. BUFALO
L4	2.4	84 - 85	MOTOR	FRONTAL / DER / IZQ	PRÓXIMAMENTE	
		84 - 86	TRANSMISIÓN	STD / 5 VEL	PRÓXIMAMENTE	
		90	TRANSMISIÓN	AUT	PRÓXIMAMENTE	
		91 - 95	TRANSMISIÓN	AUT	PRÓXIMAMENTE	
L4	2.7	96 - 00	MOTOR	FRONTAL / DER / IZQ / 4 X 4 / TRACCIÓN TRASERA	PRÓXIMAMENTE	
			TRANSMISIÓN	TRASERO / 2 X 2	PRÓXIMAMENTE	
			TRANSMISIÓN		PRÓXIMAMENTE	

CONTINÚA...



# TOYOTA

**TODO TERRENO**

4 RUNNER		MOTOR	MODELO	SOPORTE	ESPECIFICACIÓN	No. BUFALO
V6	3.0	88 - 89	TRANSMISIÓN		STD / 5 VEL	PRÓXIMAMENTE
		88 - 92	TRANSMISIÓN		AUT / 4 VEL	PRÓXIMAMENTE
		88 - 02	TRANSMISIÓN			<b>A8165</b>
		88 - 95	MOTOR		FRONTAL / DER / IZQ / 4 X 4 / TRACCIÓN TRASERA	PRÓXIMAMENTE
		90 - 95	TRANSMISIÓN		STD / 5 VEL	PRÓXIMAMENTE
		93 - 94	TRANSMISIÓN		AUT	<b>A2410</b>
		95	TRANSMISIÓN		AUT / 4 VEL	PRÓXIMAMENTE

V6	3.4	96 - 98	MOTOR		FRONTAL / DER / IZQ / 4 X 4 / TRACCIÓN TRASERA	PRÓXIMAMENTE
		96 - 02	TRANSMISIÓN			<b>A2410</b>
		99 - 02	MOTOR		FRONTAL / DER / IZQ / 4 X 4 / TRACCIÓN TRASERA	PRÓXIMAMENTE
			TRANSMISIÓN		4 X 4	PRÓXIMAMENTE



RAV 4		MOTOR	MODELO	SOPORTE	ESPECIFICACIÓN	No. BUFALO
L4	2.0	96 - 00	MOTOR		FRONTAL / AUT	PRÓXIMAMENTE
			MOTOR		FRONTAL / DER	PRÓXIMAMENTE
			MOTOR		TRASERO	PRÓXIMAMENTE
		01 - 04	MOTOR		FRONTAL / AUT	PRÓXIMAMENTE

L4	2.4	04 - 05	MOTOR		AUT	PRÓXIMAMENTE
----	-----	---------	-------	--	-----	--------------

L4	2.5	06 - 10	MOTOR		FRONTAL	PRÓXIMAMENTE
			MOTOR		FRONTAL / DER	PRÓXIMAMENTE
			MOTOR		TRASERO	PRÓXIMAMENTE
			TRANSMISIÓN		REPUESTO	PRÓXIMAMENTE
			TRANSMISIÓN		AUT / REPUESTO	PRÓXIMAMENTE



CONTINÚA...

# TOYOTA

TODO TERRENO



MR

RAV 4

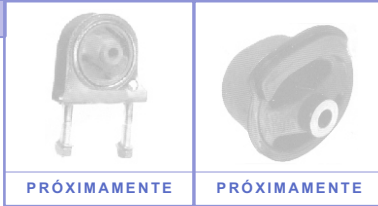

# TOYOTA

PICK UP

HILUX	MOTOR	MODELO	SOPORTE	ESPECIFICACIÓN	No. BUFALO
L4	2.0	98 - 04	MOTOR	FRONTAL / DER / IZQ	971 - A
	2.7		TRANSMISIÓN		PRÓXIMAMENTE
L4	2.7	05 - 11	MOTOR	FRONTAL / DER / IZQ	PRÓXIMAMENTE
			TRANSMISIÓN		PRÓXIMAMENTE



PICK UP	MOTOR	MODELO	SOPORTE	ESPECIFICACIÓN	No. BUFALO
L4	1.9	67 - 74	MOTOR	FRONTAL / DER / IZQ	971 - A
	2.0		TRANSMISIÓN		A2409
L4	2.2	75 - 78	TRANSMISIÓN	STD / 4 VEL	A2409
		75 - 80	MOTOR	FRONTAL / DER / IZQ	971 - A
		78 - 83	TRANSMISIÓN	AUT / STD / 5 VEL	A2410
		79 - 83	TRANSMISIÓN	4 X 4	PRÓXIMAMENTE
L4	2.4	81 - 83	MOTOR	FRONTAL / DER / IZQ	971 - A
		81 - 88	TRANSMISIÓN	4 X 4	PRÓXIMAMENTE
		81 - 95	TRANSMISIÓN	5 VEL / TRACCIÓN TRASERA	A2410
		84 - 86	TRANSMISIÓN	STD / 4 X 4	A2690
		85 - 95	MOTOR	FRONTAL / DER / IZQ	PRÓXIMAMENTE
		89 - 90	TRANSMISIÓN	AUT / 4 X 4	PRÓXIMAMENTE
		89 - 90	TRANSMISIÓN	STD / 4 X 4	PRÓXIMAMENTE
V6	3.0	88 - 95	MOTOR	FRONTAL / DER IZQ / TRACCIÓN TRASERA / 4 X 4	PRÓXIMAMENTE
			TRANSMISIÓN	AUT / STD / TRACCIÓN TRASERA	A2410
			TRANSMISIÓN	AUT / 4 X 4	PRÓXIMAMENTE
			TRANSMISIÓN	STD / 4 X 4	PRÓXIMAMENTE

CONTINÚA...



# TOYOTA

PICK UP

PICK UP						
	971-A	A2409	A2410	A2690	PRÓXIMAMENTE	PRÓXIMAMENTE
	PRÓXIMAMENTE	PRÓXIMAMENTE	PRÓXIMAMENTE			

T-100	MOTOR	MODELO	SOPORTE	ESPECIFICACIÓN	No. BUFALO
V6	2.7	94 - 98	MOTOR	FRONTAL / DER / IZQ	PRÓXIMAMENTE
			TRANSMISIÓN		A2410
V6	3.0	93 - 94	MOTOR	FRONTAL / DER / IZQ	PRÓXIMAMENTE
			TRANSMISIÓN	AUT / STD / TRACCIÓN TRASERA	A2410
			TRANSMISIÓN	4 X 4	PRÓXIMAMENTE
V6	3.4	95 - 98	MOTOR	FRONTAL / DER / IZQ	PRÓXIMAMENTE
			TRANSMISIÓN	AUT / STD / TRACCIÓN TRASERA	A2410
			TRANSMISIÓN	4 X 4	PRÓXIMAMENTE

A2410	PRÓXIMAMENTE	PRÓXIMAMENTE	PRÓXIMAMENTE

TACOMA	MOTOR	MODELO	SOPORTE	ESPECIFICACIÓN	No. BUFALO
L4	2.4	93 - 98	TRANSMISIÓN		A8165
		95 - 97	TRANSMISIÓN	TRACCIÓN TRASERA	PRÓXIMAMENTE
		95 - 04	MOTOR	FRONTAL / DER / IZQ	PRÓXIMAMENTE
V6	2.7	98 - 04	TRANSMISIÓN	TRACCIÓN TRASERA	A2410
V6	3.4	95 - 99	MOTOR	FRONTAL / DER / IZQ	PRÓXIMAMENTE
		95 - 04	TRANSMISIÓN	STD / 4 X 4	PRÓXIMAMENTE
			TRANSMISIÓN	TRACCIÓN TRASERA	A2410
		00 - 04	MOTOR		PRÓXIMAMENTE

A2410	A8165	PRÓXIMAMENTE	PRÓXIMAMENTE	PRÓXIMAMENTE	PRÓXIMAMENTE

# TOYOTA

CAMIONETAS VAN



HIACE	MOTOR	MODELO	SOPORTE	ESPECIFICACIÓN	No. BUFALO
L4 2.7	05 - 11	MOTOR	FRONTAL / DER / IZQ	PRÓXIMAMENTE	
		TRANSMISIÓN	PRÓXIMAMENTE		

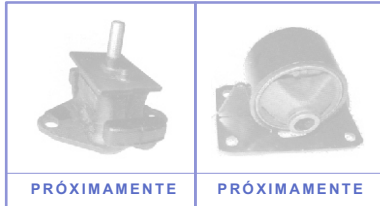

PRÓXIMAMENTE

PRÓXIMAMENTE

PREVIA	MOTOR	MODELO	SOPORTE	ESPECIFICACIÓN	No. BUFALO
L4 2.4	94 - 97	TRANSMISIÓN	DER / IZQ	PRÓXIMAMENTE	



PRÓXIMAMENTE

SIENNA	MOTOR	MODELO	SOPORTE	ESPECIFICACIÓN	No. BUFALO
V6 3.0	98 - 03	MOTOR	TORSIÓN / FRONTAL / DER	PRÓXIMAMENTE	
		MOTOR	TRASERO	<b>A 8 6 9 9</b>	
		TRANSMISIÓN	PRÓXIMAMENTE		
V6 3.3	04 - 06	MOTOR	TORSIÓN / FRONTAL / DER	PRÓXIMAMENTE	
		TRANSMISIÓN	PRÓXIMAMENTE		
V6 3.5	04 - 06	TRANSMISIÓN	PRÓXIMAMENTE		

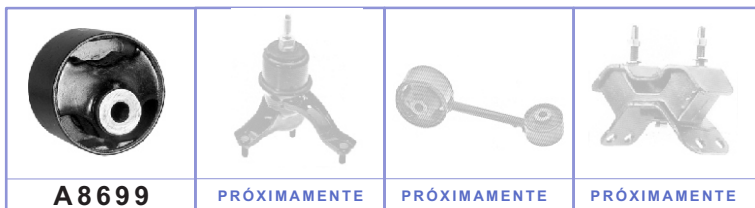

**A 8 6 9 9**

PRÓXIMAMENTE

PRÓXIMAMENTE

PRÓXIMAMENTE

# CALIDAD Y GARANTÍA DE EXPORTACIÓN



# VOLKSWAGEN

**AUTOS**

BORA	MOTOR	MODELO	SOPORTE	ESPECIFICACIÓN	No. BUFALO
L4	1.9 2.5	05 - 10	MOTOR	FRONTAL / DER / MOT. 2.5 / GASOLINA	A 199-262R
			MOTOR	FRONTAL / DER / MOT 1.9 / DIESEL	A 199-262
				FRONTAL / TODOS / MOT. 2.5	A 199-262BC
			MOTOR	CENTRAL / SUPERIOR / CON ROSCA	PRÓXIMAMENTE
			MOTOR	CENTRAL / INFERIOR / SIN ROSCA	PRÓXIMAMENTE
			MOTOR	TORSIÓN / CENTRAL	A 105
			MOTOR	TORSIÓN / CENTRAL	A 105-C
			TRANSMISIÓN	AUT	A 1172
			TRANSMISIÓN	STD	A 1272

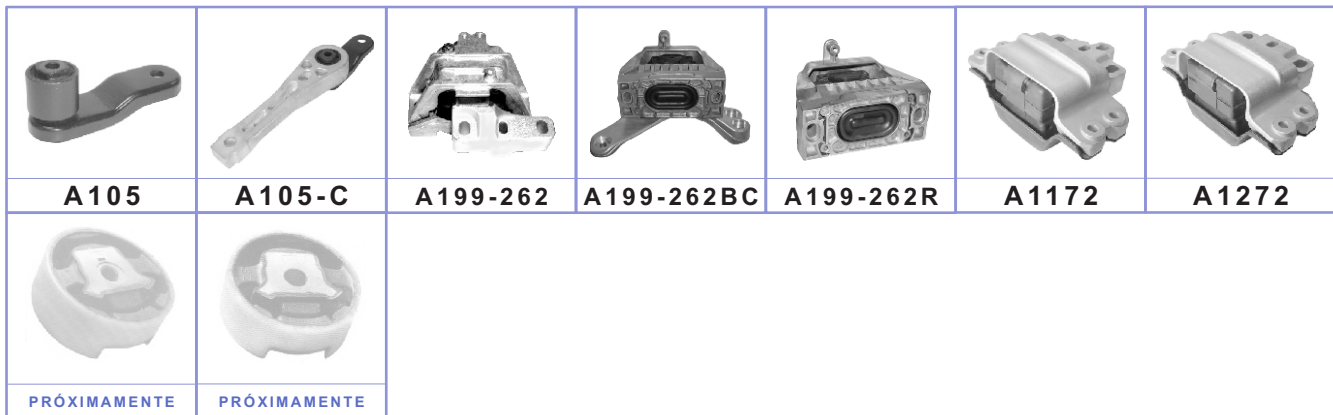







CARIBE ATLANTIC	MOTOR	MODELO	SOPORTE	ESPECIFICACIÓN	No. BUFALO
L4	1600 1700	77 - 87	MOTOR	FRONTAL / DER	7 61 - A
			MOTOR	FRONTAL / IZQ	7 61
			TRANSMISIÓN		7 66



COMBI PANEL CARAVELLE	MOTOR	MODELO	SOPORTE	ESPECIFICACIÓN	No. BUFALO
L4	1500 1600 1.8	73 - 88	TRANSMISIÓN		7 54
			MOTOR	LATERAL / DER / IZQ	7 77
			MOTOR	FRONTAL / DER / IZQ	7 34 - A
			MOTOR	FRONTAL / DER / IZQ	8 20
		89 - 00	TRANSMISIÓN	REPUESTO	PRÓXIMAMENTE
			TRANSMISIÓN		8 43
			MOTOR	REFORZADO	9 70

CONTINÚA...

<b>COMBI PANEL CARAVELLE</b>						
	<b>734-A</b>	<b>754</b>	<b>777</b>	<b>820</b>	<b>843</b>	<b>970</b>



<b>CROSS FOX LUPO</b>	MOTOR	MODELO	SOPORTE	ESPECIFICACIÓN	No. <b>BUFALO</b>
<b>L4</b>	<b>1.6</b>	<b>03 - 08</b>	MOTOR	FRONTAL / DER	<b>A 1670</b>
			MOTOR	TORSIÓN / TRASERO	<b>PRÓXIMAMENTE</b>
			TRANSMISIÓN		<b>PRÓXIMAMENTE</b>
			TRANSMISIÓN		<b>1107</b>

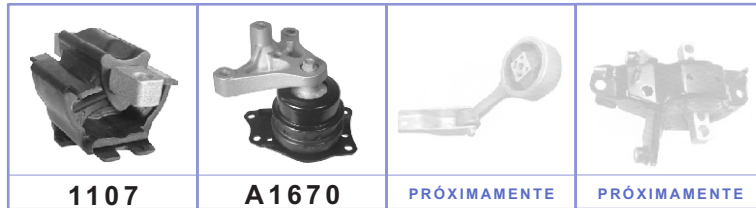

<b>CORSAR</b>	MOTOR	MODELO	SOPORTE	ESPECIFICACIÓN	No. <b>BUFALO</b>
<b>L4</b>	<b>1.8</b>	<b>80 - 92</b>	MOTOR	FRONTAL / DER / IZQ	<b>820</b>
		<b>84 - 91</b>	MOTOR	DER / IZQ / REFORZADO	<b>970</b>
			TRANSMISIÓN	AUT / STD	<b>908</b>











<b>EUROVAN</b>	MOTOR	MODELO	SOPORTE	ESPECIFICACIÓN	No. <b>BUFALO</b>
<b>L4</b> <b>L5</b>		<b>92 - 96</b>	TRANSMISIÓN	TRASERO / STD / MOT. L5 - 2.5	<b>PRÓXIMAMENTE</b>
			MOTOR	FRONTAL / DER / MOT. L4 - 1.9 / DIESEL / TDI	<b>1019</b>
		<b>00 - 06</b>	MOTOR	FRONTAL / TRASERO / MOT. L4 - 1.9 / DIESEL / TDI	<b>1091</b>
			MOTOR	FRONTAL / DER / MOT. L4 - 2.0 / GASOLINA	<b>1019</b>
			MOTOR	FRONTAL / DER / MOT. 2.5 / GASOLINA / ACV	<b>1019-A</b>
			MOTOR	FRONTAL / DER / MOT. L5 - 2.5 / GASOLINA	<b>1019</b>
			MOTOR	AUT / STD / CONTRAPESO / VR6	<b>997</b>
			MOTOR	FRONTAL / IZQ / VR6	<b>1036</b>
		<b>06 - 08</b>	TRANSMISIÓN	TRASERO / MOT. L4 - 1.9	<b>1087</b>
			MOTOR	FRONTAL / DER / MOT L4 - 1.9 / DIESEL	<b>1088</b>



# VOLKSWAGEN

AUTOS

<b>EUROVAN</b>						
	<b>997</b>	<b>1019</b>	<b>1019-A</b>	<b>1036</b>	<b>1087</b>	<b>1088</b>
						
<b>1091</b>	<b>PROXIMAMENTE</b>					

<b>GOL</b>	MOTOR	MODELO	SOPORTE	ESPECIFICACIÓN	No. BUFALO
<b>L4</b>	<b>1.8</b>	<b>08 - 10</b>	MOTOR	FRONTAL / DER / REPUESTO	<b>PROXIMAMENTE</b>
			MOTOR	FRONTAL / DER / REPUESTO	<b>PROXIMAMENTE</b>
			MOTOR	TRASERO	<b>PROXIMAMENTE</b>
			TRANSMISIÓN	REPUESTO	<b>PROXIMAMENTE</b>
			TRANSMISIÓN	REPUESTO	<b>PROXIMAMENTE</b>





				
<b>PROXIMAMENTE</b>	<b>PROXIMAMENTE</b>	<b>PROXIMAMENTE</b>	<b>PROXIMAMENTE</b>	<b>PROXIMAMENTE</b>

<b>GOLF JETTA A2</b>	MOTOR	MODELO	SOPORTE	ESPECIFICACIÓN	No. BUFALO	
<b>L4</b>	<b>1700</b>	<b>87 - 92</b>	<b>85 - 92</b>	MOTOR	FRONTAL / DER / (USA) 8 Y 16 VÁLVULAS	<b>PROXIMAMENTE</b>
			<b>85 - 97</b>	MOTOR	FRONTAL / (MEX) AUT / (USA) STD Y AUT	<b>841 - A</b>
				MOTOR	FRONTAL / 1ra EDICIÓN / REPUESTO	<b>896</b>
				MOTOR	STD	<b>841</b>
				MOTOR	FRONTAL / DER	<b>867</b>
				TRANSMISIÓN	STD	<b>848</b>
			<b>1800</b>	MOTOR	FRONTAL / 1RA. VERSIÓN (1700, 1800 CC)	<b>896 - A</b>
				TRANSMISIÓN	AUT	<b>PROXIMAMENTE</b>
				BASE	AUT / DE SOPORTE	<b>A841-273A</b>
				BASE	AUT / DE SOPORTE	<b>A841-273C</b>
				<b>01 - 02</b>	TRANSMISIÓN	

						
<b>841</b>	<b>841-A</b>	<b>848</b>	<b>848-A</b>	<b>867</b>	<b>896</b>	<b>896-A</b>

CONTINUA...



<b>GOLF JETTA A2</b>				
	<b>841-273A</b>	<b>841-273C</b>	PRÓXIMAMENTE	PRÓXIMAMENTE

<b>GOLF JETTA A-3 DERBY</b>	MOTOR	MODELO	SOPORTE	ESPECIFICACIÓN	No. <b>BUFALO</b>	
	<b>L4</b>	1.8 2.0	<b>92 - 99</b>	MOTOR	FRONTAL	<b>988</b>
				MOTOR	FRONTAL / DER	<b>989</b>
				TRANSMISIÓN	STD	<b>848</b>
				TRANSMISIÓN	AUT	PRÓXIMAMENTE
				TRANSMISIÓN	DER / EMISIÓN CALIF	PRÓXIMAMENTE
				BASE	AUT / DE SOPORTE	<b>841-273A</b>
				BASE	STD / DE SOPORTE	<b>841-273C</b>

						
<b>848</b>	<b>988</b>	<b>989</b>	<b>841-273A</b>	<b>841-273C</b>	PRÓXIMAMENTE	PRÓXIMAMENTE

<b>GOLF JETTA A-4 BEETLE (DIESEL Y GASOLINA)</b>	MOTOR	MODELO	SOPORTE	ESPECIFICACIÓN	No. <b>BUFALO</b>	
	<b>L4</b>	1.8 1.9 2.0	<b>99 - 10</b>	MOTOR	FRONTAL / DER	<b>A199-262</b>
				MOTOR	TRASERO	<b>A199-851</b>
				TRANSMISIÓN		<b>A199-555</b>







		
<b>A199-262</b>	<b>A199-555</b>	<b>A199-851</b>

<b>GOLF GTI</b>	MOTOR	MODELO	SOPORTE	ESPECIFICACIÓN	No. <b>BUFALO</b>	
	<b>L4</b>	2.0	<b>06 - 11</b>	MOTOR	FRONTAL / DER	<b>A199-262</b>
				MOTOR	CENTRAL / SUPERIOR	PRÓXIMAMENTE
				MOTOR	CENTRAL / INFERIOR	PRÓXIMAMENTE
				MOTOR	TORSIÓN / CENTRAL	<b>A105</b>
				MOTOR	TORSIÓN / CENTRAL	<b>A105-C</b>
				TRANSMISIÓN	AUT	<b>A1172</b>
				TRANSMISIÓN	STD	<b>A1272</b>

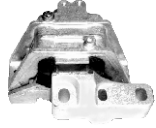

# VOLKSWAGEN

**AUTOS**

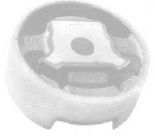
<b>GOLF GTI</b>						
	<b>A105</b>	<b>A105-C</b>	<b>A199-262</b>	<b>A1172</b>	<b>A1272</b>	<b>PRÓXIMAMENTE</b>
	<b>PRÓXIMAMENTE</b>					

<b>PASSAT</b>	<b>MOTOR</b>	<b>MODELO</b>	<b>SOPORTE</b>	<b>ESPECIFICACIÓN</b>	<b>No. BUFALO</b>
<b>L4</b>	<b>1.8</b>	<b>91 - 94</b>	MOTOR	FRONTAL / <i>TURBO</i>	<b>841</b>
			MOTOR	TRASERO / STD	<b>PRÓXIMAMENTE</b>
			MOTOR	TRASERO / AUT	<b>867</b>
			MOTOR	TRASERO	<b>A8997HY</b>
			MOTOR	TRASERO	<b>A8998HY</b>
			MOTOR	TRASERO	<b>848</b>
			MOTOR	TRASERO	<b>PRÓXIMAMENTE</b>
			MOTOR	TRASERO	<b>1125-A</b>
		<b>97 - 02</b>	MOTOR	TRASERO / IZQ	<b>A8997HY</b>
<b>L4</b>	<b>1.9</b>	<b>92 - 99</b>	MOTOR	FRONTAL	<b>841</b>
			MOTOR	FRONTAL / DER / STD	<b>PRÓXIMAMENTE</b>
			MOTOR	FRONTAL / DER / AUT	<b>867</b>
			TRANSMISIÓN	STD	<b>848</b>
		<b>92 - 97</b>	TRANSMISIÓN	AUT	<b>A8998HY</b>
			MOTOR	FRONTAL	<b>988</b>
		<b>95 - 97</b>	MOTOR	FRONTAL / DER	<b>989</b>
			TRANSMISIÓN		<b>848-A</b>
MOTOR	FRONTAL / DER / IZQ		<b>A8997HY</b>		
<b>L4</b>	<b>2.0</b>	<b>90 - 94</b>	MOTOR	FRONTAL	<b>841</b>
			MOTOR	FRONTAL / DER / STD	<b>PRÓXIMAMENTE</b>
			MOTOR	FRONTAL / DER / AUT	<b>867</b>
			TRANSMISIÓN	STD	<b>848</b>
		<b>90 - 96</b>	MOTOR	AUT	<b>848</b>
			MOTOR	FRONTAL	<b>988</b>
		<b>93 - 97</b>	MOTOR	TRASERO / DER / STD	<b>989</b>
			TRANSMISIÓN	STD	<b>848-A</b>
<b>V6</b>	<b>2.4</b>	<b>98 - 03</b>	MOTOR	FRONTAL / DER / AUT	<b>A8998HY</b>

CONTINÚA...

PASSAT	MOTOR	MODELO	SOPORTE	ESPECIFICACIÓN	No. BUFALO
	V6 2.8	93 - 97	MOTOR	FRONTAL	<b>988</b>
			MOTOR	FRONTAL / DER	<b>989</b>
			TRANSMISIÓN		<b>848</b>
		98 - 05	MOTOR	FRONTAL / DER / IZQ	<b>A8997HY</b>
			TRANSMISIÓN	DER / IZQ	<b>1125-A</b>

						
<b>841</b>	<b>848</b>	<b>848-A</b>	<b>867</b>	<b>988</b>	<b>989</b>	<b>1125-A</b>
						
<b>A897HY</b>	<b>A898HY</b>	<b>PRÓXIMAMENTE</b>	<b>PRÓXIMAMENTE</b>			

PASSAT CC	MOTOR	MODELO	SOPORTE	ESPECIFICACIÓN	No. BUFALO
	L4 2.0	2010	MOTOR	FRONTAL / DER	<b>A199-262</b>
			MOTOR	CENTRAL / SUPERIOR	<b>PRÓXIMAMENTE</b>
			MOTOR	CENTRAL / INFERIOR	<b>PRÓXIMAMENTE</b>
			TRANSMISIÓN	TORSIÓN / CENTRAL	<b>A105-C</b>
			TRANSMISIÓN		<b>A1172</b>

				
<b>A105-C</b>	<b>A199-262</b>	<b>A1172</b>	<b>PRÓXIMAMENTE</b>	<b>PRÓXIMAMENTE</b>

POINTER	MOTOR	MODELO	SOPORTE	ESPECIFICACIÓN	No. BUFALO
	L4 1.8	97 - 08	MOTOR	FRONTAL / DER / IZQ	<b>820</b>
			TRANSMISIÓN		<b>947</b>
	2.0	09 - 20	MOTOR	FRONTAL / DER / IZQ	<b>PRÓXIMAMENTE</b>

		
<b>820</b>	<b>947</b>	<b>PRÓXIMAMENTE</b>



# VOLKSWAGEN

**AUTOS**

POLO	MOTOR	MODELO	SOPORTE	ESPECIFICACIÓN	No. BUFALO
L4	1.6	03 - 08	MOTOR	FRONTAL / DER / AUT	<b>A 1670</b>
			MOTOR	TORSIÓN / TRASERO	PRÓXIMAMENTE
			TRANSMISIÓN	STD	PRÓXIMAMENTE
			TRANSMISIÓN		<b>1107</b>

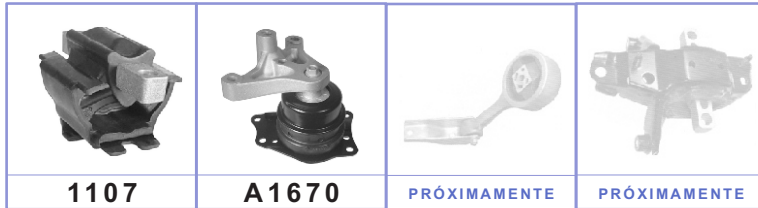

SEDAN BRASILIA	MOTOR	MODELO	SOPORTE	ESPECIFICACIÓN	No. BUFALO
L4	1500	74 - 00	MOTOR	FRONTAL / DER / IZQ	<b>500</b>
			TRANSMISIÓN	1500CC	<b>552</b>
			TRANSMISIÓN		<b>718</b>
	1600	94 - 96	MOTOR	DER / 1600i / ECOLÓGICO	<b>871</b>
			MOTOR	IZQ / 1600i / ECOLÓGICO	<b>872</b>
			MOTOR	FRONTAL / DER / IZQ	<b>734</b>

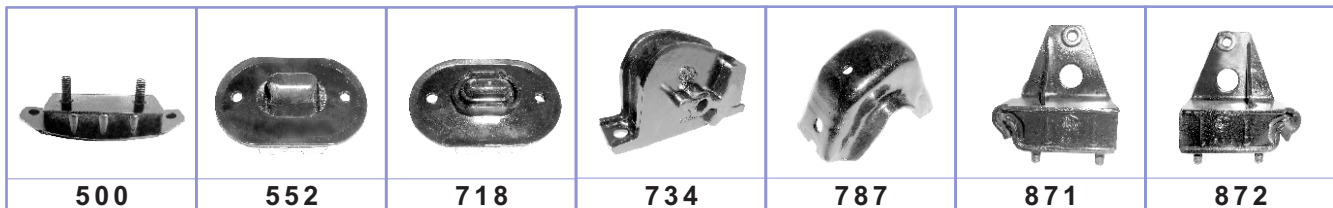



# NUEVOS VARIOS

**AUTOS, TODO TERRENO  
PICK UP, CAMIONETAS VAN**

MOTOR	MODELO	SOPORTE	ESPECIFICACIÓN	No. BUFALO

MOTOR	MODELO	SOPORTE	ESPECIFICACIÓN	No. BUFALO



# NUEVOS VARIOS

**AUTOS, TODO TERRENO  
PICK UP, CAMIONETAS VAN**

MOTOR	MODELO	SOPORTE	ESPECIFICACIÓN	No. BUFALO

MOTOR	MODELO	SOPORTE	ESPECIFICACIÓN	No. BUFALO

# BUFALO AHM

---

## CATÁLOGO *Dosmil12*



MR

MISCELÁNEA  
HULE METAL

**AUTOMÓVILES**  
**CAMIONETAS**

---

SECCIÓN III





# AUMENTO RESORTE

AUTO - CAMIONETA



**MUELA**

**10125**  
LARGO  
X = 1 5/8"

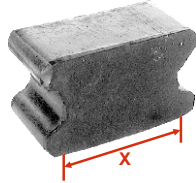

**MUELA**

**10125-A**  
LARGO  
CON SEGURO  
X = 1 5/8"

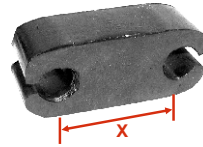

**MUELA**

**10125-B**  
LARGO  
X = 1 1/8"

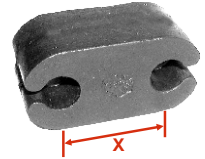

**MUELA**

**10125-C**  
LARGO  
X = 1 1/4"

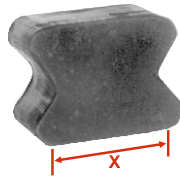

**CHRYSLER**

**10131-C**  
Shadow  
Spirit



**CHRYSLER**

**10142**  
Dart



**DATSUN**

**10130**  
Astriado



**FORD**

**10135**  
Fairmont  
Mustang

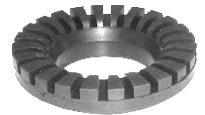

**RAMBLER**

**10139\***  
Diam. Int.= 3 5/8"  
Espesor= 1 1/2"



**RAMBLER**

**10139-A**  
Abierto



**VOLKSWAGEN**

**10143**  
Golf  
Jetta



**UNIVERSAL**

**10128**  
Diam. Int.= 3 1/2"  
Espesor= 1/2"



**UNIVERSAL**

**10129**



**UNIVERSAL**

**10131**  
Diam. Int.= 4"  
Espesor= 1/2"



**UNIVERSAL**

**10132**  
Diam. Int.= 3 1/4"  
Espesor= 1/2"



**UNIVERSAL**

**10133**  
Diam. Int.= 3 1/4"  
Espesor= 5/8"



**UNIVERSAL**

**10134**  
Abierto  
Diam. Int.= 3 5/8"  
Espesor= 1/2"



**UNIVERSAL**

**10138**  
Abierto  
Diam. Int.= 3 1/4"  
Espesor= 1"





# BARRA ESTABILIZADORA

AUTO - CAMIONETA

## CHEVROLET

**ES-11**  
 Caprice  
 Chevelle  
 Impala  
 Malibú  
 Montecarlo  
 Nova



**ES-13**  
 Cavalier



**ES-14**  
 Celebrity  
 Citation  
 Mod. 82 - 87



**ES-27=8131**  
 Camioneta  
 Microbus



**ES-28**  
 Celebrity  
 Century  
 Cutlass

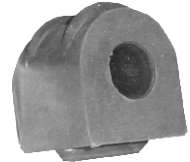

**ES-29**  
 Citation



**ES-45**  
 Camioneta  
 Pick Up  
 Mod. 99-02

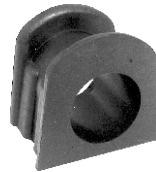

**ES-48**  
*(INTERIOR)*  
 Cutlass

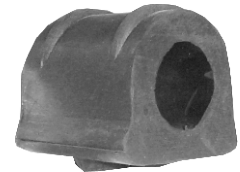

**ES-51**  
 Chevy  
*(TODOS)*  
 Mod. 94-02



**ES-53**  
 Auto  
 Chevelle



**ES-61**  
 Cavalier  
 Cutlass  
 Izq.



**ES-75**  
 Cutlass



**ES-101**  
 Colorado  
 Mod. 04-09

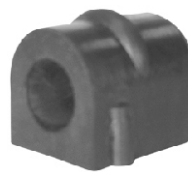

**ES-105**  
 HHR  
 Mod. 04-09



**ES-110**  
 Vectra  
*(VARILLA)*



**ES-114**  
 Geo  
 Tracker  
*(VARILLA)*



**ES-521**  
 Aveo



**ES-525**  
 Meriva



# BARRA ESTABILIZADORA

AUTO - CAMIONETA



## CHRYSLER

	<p><b>ES-09</b> Camioneta (GOMA PARA TORNILLO) Mod. 77-84</p> 	<p><b>ES-35</b> Dart-K Mod. 88-90</p> 
<p><b>ES-36</b> Dart-K (COMPLETO)</p> 	<p><b>ES-37</b> Dart-K (CUADRADO) Mod. 83-97</p> 	<p><b>ES-38</b> Spirit</p> 
<p><b>ES-47</b> Ram Charger</p> 	<p><b>ES-52</b> Voyager</p> 	<p><b>ES-54</b> Windstar</p> 
<p><b>ES-56</b> Ram Charger (ORIFICIO GRANDE)</p> 	<p><b>ES-60</b> Atos</p> 	<p><b>ES-62</b> Cirrus Intrepid Stratus Der. Mod. 97-00</p> 
<p><b>ES-63</b> Neón</p> 	<p><b>ES-66</b> Ram Charger</p> 	<p><b>ES-67</b> Caravan Voyager</p> 
<p><b>ES-68</b> Spirit Shadow (CUADRADA) Mod. 89-94</p> 	<p><b>ES-72</b> Ram (ORIFICIO GRANDE)</p> 	<p><b>ES-74</b> Ram Charger</p> 
<p><b>ES-81</b> Cherokee (GRANDE)</p> 	<p><b>ES-83</b> Dakota</p> 	<p><b>ES-103</b> Caliver Mod. 07-09</p> 



# BARRA ESTABILIZADORA

AUTO - CAMIONETA

CHRYSLER

**ES-107**  
Voyager  
(VARILLA)  
Trasera



**ES-527**  
Stratus



FORD

**ES-30**  
Muatang  
Fairmont



**ES-31=8130**  
Topaz

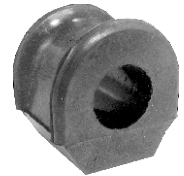

**ES-33**  
Jorobada

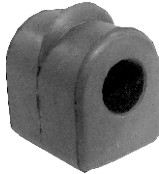

**ES-46**  
Grand Marquis



**ES-50**  
Grand Marquis  
Mod. 92-98

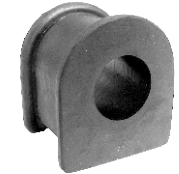

**ES-57**  
Lobo  
Mod. 00-05



**ES-59**  
Escor  
Mod. 98-01t

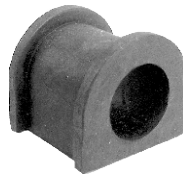

**ES-65**  
Fiesta  
Escort  
Mod. 98-01



**ES-71**  
Focus  
Der. Izq



**ES-77**  
Ranger Americana  
(CENTRO  
CHICO)



**ES-78**  
Ranger Americana  
(CENTRO  
GRANDE)



**ES-79**  
Ranger  
Delantera



**ES-80**  
Ranger  
(CUADRADA)



**ES-86**  
Expedition



# BARRA ESTABILIZADORA

AUTO - CAMIONETA



**ES-93**  
Contour  
Mistique  
Mod. 96-02



**ES-94**  
Escort  
Mod. 02-04



**ES-102**  
Fiesta



**ES-111**  
Escape



**ES-112**  
Expedition  
Lobo

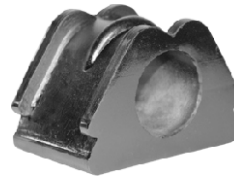

**H O N D A**

**ES-84**  
(*TODOS*)



**ES-109**  
Odyssey  
Mod. 99-08



**ES-116**  
CR-V  
Mod. 02-08



**ES-522**  
Honda



**J E E P - C H Y S L E R**

**ES-115**  
Jeep Liberty



**N I S S A N**

**ES-15**  
Tsuru II  
(*GRANDE*)  
Trasero



**ES-16**  
Tsuru II  
(*CHICA*)  
Trasero



**ES-21**  
Tsuru II  
Mod. 88-92

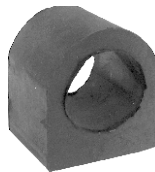

**ES-22**  
Tsuru I  
Tsuru II  
Delantero



**ES-23**  
Tsuru I  
(*COSTILLA*)  
Trasero





# BARRA ESTABILIZADORA

AUTO - CAMIONETA

**N I S S A N**

**ES-25=8129**

Datsun  
Mod. 79-84



**ES-26**

Tsuru III  
Delantero



**ES-39**

Tsuru I  
Mod. 84-87

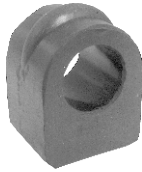

**ES-41=8132**

Tsuru III



**ES-42**

Tsuru III  
Trasero



**ES-44**

Tsuru I  
Mod. 84-87

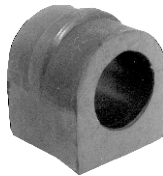

**ES-70**

Datsun  
Pick Up  
Mod. 79-97



**ES-76**

Tsuru II  
Pick Up  
Mod. 91-92



**ES-87**

Urvan  
Delantero



**ES-88**

Urvan  
Trasero



**ES-89**

Quest



**ES-106**

Altima  
Maxima



**ES-8127**

Datsun  
Pick Up



**ES-8127-A**

Pick Up  
(TORSIÓN)



# CALIDAD Y GARANTÍA

# BARRA ESTABILIZADORA

AUTO - CAMIONETA



PEUGEOT

**A4083**  
206  
Diam. 19 mm.

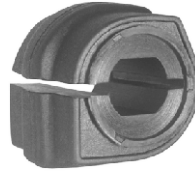

RENAULT

**ES-40**  
R-18  
Mod. 80-85



**A4103**  
Megane



TOYOTA

**ES-104**  
Hiace  
Mod. 04-09



**ES-104**  
Camry  
(*TODOS*)



VOLKSWAGEN

**ES-01**  
Golf  
Jetta



**ES-49**  
Golf  
Jetta  
(*NUEVOS*)



**ES-55**  
Jetta A3  
Jetta A4



**ES-49**  
Golf  
Jetta A4



**ES-58**  
Corsar  
Golf  
Jetta



**ES-73**  
Golf  
Jetta A4



**ES-82**  
Jetta A4



**ES-85**  
Eurovan  
(*CENTRO GRANDE*)  
Izquierdo  
(*TODOS*)



**ES-90**  
Eurovan  
(*CENTRO CHICO*)  
(*TODOS*)





# BASES AMORTIGUADOR

AUTO - CAMIONETA

## CHEVROLET

**916**  
Cutlass  
Trasero  
6 y 8 Cil.



**1086**  
Astra  
Zafira  
1.8, 2.0 Lts.  
Delantero  
Mod. 02-06



**K-90445207**  
Chevy



## CHRYSLER

**907**  
(*TODOS*)  
Sin Baleros  
Delantero  
Mod. 82-90



## FORD

**842**  
Topaz  
Delantero  
Mod. 93-95



**903**  
Guia  
Topaz  
Mod. 92-96



**937**  
Guia  
Topaz  
Trasero  
Mod. 85-95



## NISSAN

**944-B**  
Tsuru II  
Delantero



**945**  
Tsuru III  
Tsuru GS, GST  
Std. Aut.  
Delantero  
Mod. 92-97



**945-A**  
Tsuru III  
Tsuru GS, GST  
Std. Aut.  
Trasero  
Mod. 92-97



**1048**  
Almera  
Sentra  
Mod. 02-06



**A1620**  
Platina  
(*TAPA*  
*TUERCA*)  
Delantero



**A9529**  
Platina





# BASES AMORTIGUADOR

AUTO - CAMIONETA



MR

## VOLKSWAGEN

**892**  
Atlantic  
Caribe  
Delantero



**944**  
Corsar  
Pointer



**946**  
Golf  
Jetta A2  
Mod. 87-92



**948**  
Golf  
Jetta A4  
Delantero



**949**  
Golf  
Jetta A4  
Trasero



**1102**  
Pointer



**K-171-412-329**  
Golf  
Jetta A2



**K-1815**  
Golf  
Jetta A4



**K-191-412-329**  
Golf  
Jetta A2



**K-357-412-331-A**  
Golf  
Jetta A3



**K-5X0-412-331-A**  
Pointer



MR



# BUJES SUSPENSIÓN

AUTO - CAMIONETA

CHEVROLET

**968-M**  
P/Horquilla  
Malibú  
L4  
Mod. 97-03



**3525**  
Eje Trasero  
Chevy  
Monza  
(TODOS)



**A4375**  
P/Horquilla  
Vectra



**K-2261-0297**  
P/Horquilla  
Cavalier



**K-2261-3954**  
P/Horquilla  
Cavalier  
Inferior  
Mod. 99-01



**K-305**  
P/Horquilla  
Autos  
Superior  
Mod. 58-70



**K-3090 (JGO)**  
P/Barra Tensora  
Rambler



10 Piezas

**K-5274**  
P/Horquilla  
Chevrolet  
Trasero  
Mod. 88-92



**K-6108**  
P/Horquilla  
Chevrolet  
Mod. 71-73



**K-6109 (JGO)**  
P/Horquilla  
Chevrolet  
Inferior  
Mod. 71-82



2 Piezas

**K-6137**  
P/Horquilla  
Camionetas  
C-10  
Inferior  
Mod. 73-86



**K-6138**  
P/Horquilla  
Camionetas  
C-10  
Superior  
Mod. 73-86



**K-6109 (JGO)**  
P/Horquilla  
Chevrolet  
Superior  
Mod. 74-78



2 Piezas

**K-6176**  
P/Horquilla  
Autos  
Superior  
Mod. 78-88



**K-6198**  
P/Horquilla  
Chevrolet  
Inferior  
Mod. 82-91



**K-6271**  
P/Horquilla  
Autos  
Inferior  
Mod. 82-91



**K-6282 (JGO)**  
P/Horquilla  
Camionetas  
S-10  
Mod. 82-95



**K-6298**  
P/Horquilla  
Camionetas  
GMC  
Superior



**K-6284 (JGO)**  
P/Horquilla  
Cavalier  
Inferior  
Mod. 82-86



2 Piezas

2 Piezas

# BUJES SUSPENSIÓN

AUTO - CAMIONETA



**K-6288**  
P/Eje  
Autos  
Trasero



**K-6323**  
P/Horquilla  
Camionetas  
C-1500  
Superior  
Mod. 92-98



**K-6325**  
P/Suspensión  
Camionetas  
C-3500  
Superior  
Mod. 88-89



**K-6327 (JGO)**  
P/Horquilla  
C-1500  
C-3500  
Inferior  
Mod. 92-98



2 Piezas

**K-6531 (JGO)**  
P/Vieleta  
Autos  
Mod. 88-94



6 Piezas

**K-6351 (JGO)**  
P/Horquilla  
Cavalier  
Inferior  
Mod. 87-94



2 Piezas

**K-6395**  
P/Horquilla  
Camionetas  
C-3500  
Superior  
Mod. 89-98



**K-6578 (JGO)**  
P/Horquilla  
Cavalier  
Inferior  
Mod. 95-00



2 Piezas

**K-6689**  
P/Horquilla  
Camaro  
Superior



**K-63607**  
Buje Chico  
Rep. K-6351



**K-1403010**  
P/Horquilla  
Bravada  
Envoy  
Xtrail  
Blazer 4X2, 4X2  
Mod. 02-08



**K-90217845**  
P/Eje  
Chevy  
Trasero  
Mod. 94-07



**K-90217845**  
P/Eje  
Chevy Brasil  
Mod. 99-03  
Chevy México  
Mod. 94-12  
Pick Up  
Mod. 99-03  
Corsa  
Mod. 94-01  
Trasero



**K-90445098**  
Goma P/Tirante  
Chevy



**K-EV-119**  
P/Vieleta  
Autos





# BUJES SUSPENSIÓN

AUTO - CAMIONETA

CHRYSLER

**1053**  
*Eje Trasero*  
Atos



**3526**  
*P/Horquilla*  
Atos  
Delantero  
(TODOS)



**3537**  
*P/Horquilla*  
Atos  
Trasero  
(TODOS)



**K-6325**  
*P/Horquilla*  
Grand Voyager  
Town & Country  
4X4  
Inferior  
Izq.  
Mod. 01-07



**K-1406005**  
*P/Varilla*  
Caravan  
Grand Voyager  
Mod. 01-07



**K-1406014**  
*Buje Derecho*  
Caravan  
Grand Caravan  
Grand Voyager  
Voyager  
Town & Country  
Mod. 01-07



**K-1406015**  
*Buje Izquierdo*  
Caravan  
Grand Caravan  
Grand Voyager  
Voyager  
Town & Country  
Mod. 01-07



**K-4322834**  
*P/Horquilla*  
Shadow  
Spirit  
Inferior  
Mod. 85-89



**K-4449269**  
*P/Horquilla*  
Shadow  
Spirit  
Inferior  
Mod. 85-89



**K-4449369**  
*P/Horquilla*  
Shadow Spirit  
Inferior  
Mod. 89-95



**K-4626026**  
*P/Horquilla*  
Shadow  
Spirit  
Trasero  
Mod. 87-95



**K-4684548**  
*P/Horquilla*  
Voyager  
Delantero



**K-4689120**  
*P/Horquilla*  
Voyager  
Superior  
Mod. 94-07



**K-5272098**  
*P/Horquilla Grande*  
Shadow  
Spirit  
Inferior  
Mod. 89-95



**K-5272250**  
*P/Horquilla Grande*  
Neón  
Inferior  
Mod. 00-(+)



**K-7244 (JGO)**  
*P/Horquilla*  
Neón  
Inferior  
Mod. 95-97

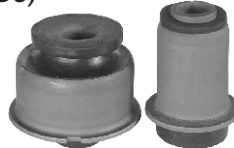

2 Piezas

**K-7244 (JGO)**  
*P/Horquilla*  
Stratus  
Inferior



2 Piezas

**K-G-7163 (JGO)**  
*P/Barra*  
Autos "K"  
Mod. 65-78

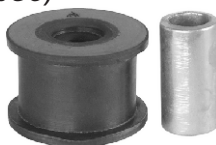

2 Piezas



# BUJES SUSPENSIÓN

AUTO - CAMIONETA



**D O D G E**

**K-408**  
P/Horquilla  
Autos  
Mod. 62-75



**K-4106153**  
P/Barra de Torción  
Dodge Aut.  
Mod. 77-82



**K-791**  
P/Horquilla  
Autos  
Inferior  
Mod. 62-75



**K-791**  
P/Horquilla  
Camionetas  
D-100  
D-300  
Superior  
Mod. 70-89



**K-7040 (JGO)**  
P/Barra Tensora  
Mod. 60-72



8 Piezas

**K-7049 (JGO)**  
P/Braza Auxiliar  
Mod. 71-83



3 Piezas

**K-7065**  
P/Horquilla  
Camionetas  
D-350  
Inferior  
Mod. 72-91



**K-7077**  
P/Horquilla  
D-100  
D-150  
Mod. 72-91



**K-7079 (JGO)**  
P/Barra Tensora  
Camioneta  
Mod. 72-91



8 Piezas



**K-7083 (JGO)**  
P/Barra Tensora  
Camionetas Van  
Mod. 76-78



8 Piezas

**K-7084**  
P/Horquilla  
Dodge  
Mod. 76-82



**K-6327 (JGO)**  
Tornillo P/Barra  
Estabilizadora  
Autos  
Mod. 76-82



**K-7090 (JGO)**  
P/Barra Tensora  
Camionetas Van



8 Piezas



# BUJES SUSPENSIÓN

AUTO - CAMIONETA

**K-7092 (JGO)**  
Abrazadera  
Barra Estabilizadora



12 piezas

**K-7098 (JGO)**  
P/Barra Tensora  
Autos "K"  
Mod. 82-86



10 Piezas

**K-7276**  
P/Horquilla  
Camionetas  
Superior  
Mod. 94-02



**K-7278**  
P/Horquilla  
Camionetas  
Ram 3500  
4X4  
Superior



**3526**  
P/Horquilla  
D-50  
Ram 50 1/2 Ton  
Inferior  
Mod. 79-92



**DODGE**  
**CHRYSLER**

**K-54551-25000**  
P/Horquilla  
Chico  
Verna  
Inferior  
Mod. 03-08



**K-54551-25000**  
P/Horquilla  
Grande  
Verna  
Inferior  
Mod. 03-08



**JEEP**  
**CHRYSLER**

**K-3128**  
Eje Trasero  
Cherokee  
Superior



**K-3130**  
P/Horquilla  
Jeep  
Grand Cherokee  
Inferior



**K-3131**  
P/Horquilla  
Jeep  
Grand Cherokee  
Superior



**K-3167 (JGO)**  
P/Horquilla  
Jeep  
Grand Cherokee  
Inferior



2 Piezas

**K-1406001**  
P/Horquilla  
Liberty 4X4  
Mod. 02-07  
Nitro  
Mod. 07-12  
Superior



**K-1406043**  
P/Horquilla  
Grand Cherokee  
Mod. 99-04  
Liberty 4X4  
Mod. 02-07  
Superior



**K-3025002**  
Suspensión  
Liberty  
Mod. 02-07



# BUJES SUSPENSIÓN

AUTO - CAMIONETA



F O R D

**1029**  
P/Horquilla  
Escape  
Explorer  
Delantero



**1070**  
P/Eje  
Fiesta  
Ikon  
Courier  
Trasero



**1080**  
P/Horquilla  
Villager  
Inferior  
Mod. 93-02



**1082**  
P/Horquilla  
Villager  
Mod. 00-07



**A4050**  
Punta de  
Horquilla  
Focus  
Delantero  
Mod. 02-03



**K-226**  
P/Horquilla  
Fairmont  
Mod. 78-84



**K-3287**  
P/Horquilla  
Fairmont  
Mod. 78-84



**K-3288**  
P/Horquilla  
Mustang  
Trasero  
Mod. 79-84



**K-8083**  
P/Horquilla  
Galaxie  
Superior  
Mod. 65-72



**K-8034**  
P/Horquilla  
Autos  
Inferior  
Mod. 62-66



**K-8095**  
P/Eje  
Camionetas  
Mod. 71-79



**K-8101 (JGO)**  
P/Barra Tensora  
Camionetas  
Mod. 72-91



4 Piezas

**K-8103**  
P/Brazo Auxiliar  
Autos  
Mod. 65-91



**K-8125 (JGO)**  
P/Barra Tensora  
Galaxie  
Mod. 65-78



8 Piezas

**K-8132**  
P/Horquilla  
Autos  
Inferior  
Mod. 66-77



**K-8146 (JGO)**  
P/Tirante  
F-100  
F-150  
F-300  
Mod. 65-79



8 Piezas





# BUJES SUSPENSIÓN

AUTO - CAMIONETA

**K-8157 (JGO)**  
*P/Barra Tensora*  
Autos Mod. 65-78



10 Piezas



**K-8181 (JGO)**  
*P/Barra Tensora*



4 Piezas



**K-8196 (JGO)**  
*P/Barra Tensora*



8 Piezas

**K-8202**  
*P/Horquilla*  
Autos Superior Mod. 72-79



**K-8219**  
*P/Horquilla*  
Mustang Superior Mod. 74-78



**K-8268 (JGO)**  
*P/Barra Tensora*  
Ecoline Van



10 Piezas

**K-8276 (JGO)**  
*P/Horquilla*  
Superior Mod. 74-78



2 Piezas

**K-8292**  
*P/Pivote Axial*  
F-100 F-350 Mod. 80-97



**K-8295 (JGO)**  
*P/Tirantes*  
F-150 F-350 Mod. 65-79



10 Piezas

**K-8300**  
*P/Pivote Axial*  
F-100 F-150 Mod. 80-81



**K-8416**  
*Rótula de Tiempo*  
Mod. 83-84



**K-8417**  
*P/Horquilla*  
Topaz Inferior Mod. 84-90



**K-8417-S**  
*P/Horquilla*  
Tubo suelto Topaz Inferior





# BUJES SUSPENSIÓN

AUTO - CAMIONETA



**K-8436**  
P/Horquilla  
Topaz  
Inferior  
Mod. 83-94



**K-8509 (JGO)**  
P/Tirantes  
F-250



10 Piezas

**K-8521**  
P/Horquilla  
Mercury  
Cougar  
Mod. 89-97  
Rep. K8766



**K-8526 (JGO)**  
P/Barra Tensora  
Taurus  
Mod. 86-89  
Rep. K-8516



4 Piezas

**K-8604**  
P/Horquilla  
Superior  
Mod. 87-89



**K-8606**  
P/Eje  
Camioneta  
Ranger  
Mod. 89-96



**K-8613**  
P/Eje  
Ranger  
Mod. 89-96



**K-8614 (JGO)**  
P/Barra  
Estabilizadora  
Topaz  
Mod. 83-94



10 Piezas

**K-8645**  
P/Barra Tensora  
Thunderbird  
Mod. 83-94



**K-8659 (JGO)**  
P/Barra Tensora



10 Piezas

**K-3287**  
P/Eje  
Explorer  
Mod. 91-94



**K-8680 (JGO)**  
Platillo  
Cougar  
Thunderbird  
Mod. 89-95



8 Piezas

**K-8703**  
P/Horquilla  
Grand Marquis  
Superior



**K-8704**  
P/Horquilla  
Explorer  
Ranger  
Superior



**K-8706**  
P/Horquilla  
Cougar  
Thunderbird  
Superior  
Mod. 89-95



**K-8721**  
P/Horquilla  
Camionetas  
Lobo  
Superior





# BUJES SUSPENSIÓN

AUTO - CAMIONETA

**K-1097918**

*P/Horquilla*  
Focus  
Americano  
Mod. 99-06



**K-1408040**

*P/Horquilla*  
Expedition 4X2  
Lobo 4X4  
F-150  
Mod. 04-06  
Mark LT 4X2, 4X4  
Mod. 06-08



**K-96FB-3A262**

*P/Horquilla Grande*  
Fiesta  
Mod. 00-07



**K-B455-3446Y-A**

*P/Horquilla*  
Escort  
Delantero



**K-BH93-BBSK-566RPT**

*P/Brazo Estabilizador*  
Countur  
Mistique



**2 Piezas**

**K-E9SZ-3A140-A**

*P/Barra*  
Thunderbird  
Mod. 88-94



**H O N D A**

**1031**

*P/Horquilla*  
Accord  
Civic  
Delantero



**1032**

*P/Horquilla*  
Accord  
Civic  
Trasero



**K-9468**

*P/Horquilla*  
Superior  
Mod. 94-97



**I S U Z U**

**K-9468**

*P/Horquilla*  
Superior  
Mod. 94-97



**N I S S A N**

**619**

*Porta Mango*  
Datsun



**620**

*P/Horquilla*  
Datsun



# BUJES SUSPENSIÓN

AUTO - CAMIONETA



**869**  
P/Horquilla  
Tsuru II  
Trasero  
Mod. 88-92



**869-A**  
P/Horquilla  
Tsuru III  
Trasero  
Mod. 92-06



**K-8509 (JGO)**  
P/Horquilla  
Sentra  
Delantero



**K-8509 (JGO)**  
P/Horquilla  
Platina



**K-54131-H100**  
P/Horquilla  
Autos  
Mod. 79-84



**K-54423-B9500**  
P/Horquilla  
Camionetas  
Mod. 79-93



**K-54476-03WG0 (JGO)**  
P/Barra Tensora  
Camionetas  
Mod. 81-96



10 Piezas



**K-54476-2100 (JGO)**  
P/Barra Tensora  
Mod. 69-78



10 Piezas



**K-54476-W5000 (JGO)**  
P/Barra Tensora  
Autos



10 Piezas

**K-54504-01A10**  
P/Horquilla  
Tsuru I  
Inferior



**K-54505-01A10**  
P/Horquilla  
Tsuru I  
Inferior



**K-54506-B9500**  
P/Horquilla  
Pick Up  
Superior  
Mod. 79-93



**K-54535-A0801**  
P/Horquilla  
Inferior  
mod. 70-78



**K-54560-01G00**  
P/Horquilla  
Camionetas  
Inferior  
Mod. 95-03



**K-54560-50A00**  
P/Horquilla  
Tsuru II  
Tsuru II  
Inferior  
Mod. 88-00



**K-54560-VW000**  
P/Horquilla (CHICO)  
Urban  
Inferior





# BUJES SUSPENSIÓN

AUTO - CAMIONETA

**K-54560-VW010**  
*P/Horquilla (GRANDE)*  
Urban  
Inferior



**K-54560-VW010**  
*P/Horquilla*  
Tsuru II  
Trasero  
Mod. 88-92



**K-55045-08M00**  
*P/Horquilla*  
Tsuru I  
Trasero  
Mod. 84-87



**K-55148-50A00**  
*P/Barra Estabilizadora*  
Tsuru II  
Trasero  
Mod. 88-92



**K-55152-50A10**  
*P/Horquilla*  
Tsuru I  
Trasero  
Mod. 88-92



**K-55193-50A00**  
*P/Barra Estabilizadora*  
Tsuru II  
Mod. 88-92



**K-9515 (JGO)**  
*P/Barra Tensora*  
Camioneta  
Mod. 97



10 Piezas



**K-HA-8500 (JGO)**  
*P/Barra Tensora*



10 Piezas



**K-HA-9500 (JGO)**  
*P/Tirante*  
Tsuru II  
Tsuru III



10 Piezas

**K-1416012**  
*P/Buje Chico*  
Rogue  
Mod. 08-09  
Sentra  
Mod. 96-00  
X-Trail  
Mod. 02-07



## RAMBLER

**K-3000 (JGO)**  
*P/Brazo Auxiliar Buje de Campana*  
Rambler



3 Piezas

**K-3059**  
*P/Horquilla*  
Rambler  
American  
Inferior  
Mod. 64-83



**K-3088**  
*P/Horquilla*  
Rambler  
American  
Inferior  
Mod. 70-83



# BUJES SUSPENSIÓN

AUTO - CAMIONETA



## RENAULT

**A4094**  
P/Horquilla  
Clio



**K-7700-509-247**  
P/Vieleta  
(TODOS)



**K-7701-348-037**  
P/Horquilla  
R-4  
R-5  
Superior  
Mod. 76-84



**K-7701-348-040**  
P/Horquilla  
R-12  
R-18  
Inferior  
Mod. 72-86



## TOYOTA

**K-9201**  
P/Horquilla  
Camionetas  
Inferior  
Mod. 79-82



**K-9210**  
P/Horquilla  
Pick Up  
Superior  
Mod. 79-83



**K-9548 (JGO)**  
P/Horquilla  
Camionetas  
Superior  
Mod. 86

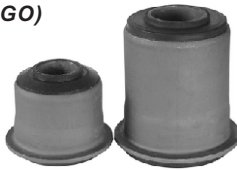

2 Piezas



## VOLKSWAGEN

**870**  
P/Horquilla  
Caribe  
Trasero  
Mod. 78-85



**870-A**  
P/Eje  
Caribe  
Trasero  
Mod. 78-85



**968**  
P/Horquilla  
Jetta A4  
Superior  
Mod. 99-02



**968-A**  
P/Horquilla  
(ALUMINIO)  
Golf  
Jetta A4  
Superior  
Mod. 99-02  
Diámetro Interior: 1/2"



**968-B**  
P/Horquilla  
Golf  
Jetta A4  
Superior  
Mod. 99-02  
Diámetro Interior: 11/16"



**1023-B**  
P/Horquilla  
Eurovan  
L5  
V6



**1069**  
P/Eje  
Eurovan  
Polo  
Luppo



**3519**  
P/Horquilla  
Golf  
Jetta A4  
Inferior





# BUJES SUSPENSIÓN

AUTO - CAMIONETA

**3520**

*P/Horquilla*  
Golf  
Jetta A3  
Jetta A4  
Trasero



**A541**

*P/Horquilla*  
Golf  
Jetta A2  
Trasero  
Mod. 87-92



**A541-A**

*P/Horquilla*  
Golf  
Jetta A3  
Trasero  
Mod. 93-99

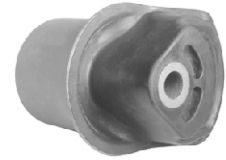

**A541-B**

*P/Eje*  
Golf  
Jetta A4



**A770**

*P/Horquilla*  
Eurovan  
Superior  
Derecho



**A4670**

*P/Eje*  
Lupo  
Mod. 06-07  
Polo  
Mod. 04-07



**K-171-407-182-D**

*P/Horquilla*  
Atlantic  
Caribe  
Inferior  
Mod. 77-87



**K-191-307-181-A**

*P/Horquilla*  
Golf  
Jetta  
Inferior  
Mod. 88-94



**K-191-407-181-AA**

*P/Horquilla*  
Jetta  
Inferior  
Mod. 88



**K-191-407-282-E**

*P/Horquilla*  
Golf  
Jetta  
Mod. 88-94  
S/C



**K-191-407-282-EE**

*P/Horquilla (GRANDE)*  
Golf  
Jetta  
Dirección  
Hidráulica  
Mod. 88-94



**K-1J0-407-181-A**

*P/Horquilla*  
Golf  
Jetta A4



**K-305-419-809**

*P/Varilla  
de Dirección*  
Pointer



**K-701-419-081-A**

*P/Varilla  
de Dirección*  
Eurovan



**K-811-407-181-A**

*P/Horquilla*  
Corsa  
Inferior



V A R I O S

**K-G-6135**

*Cubre Polvo  
P/Barra*  
Rep. K-6135



**K-G-6147**

*Cubre Polvo  
P/Barra*  
Rep. K-6147



# CALIPER

AUTO - CAMIONETA



## CHEVROLET

**CL-9**  
Universal  
Longitud 5.4 cm



**CL-13**  
Camioneta  
Longitud 4.9 cm



**CL-14**  
Lumina  
Shilhouette  
Venture



## CHRYSLER

**CL-1**  
Linea K  
Longitud 5.3



**CL-06**  
Linea K  
Longitud 5.0 cm



## FORD

**CL-02**  
Antiguo  
Alto  
Longitud: 4.7 cm



**CL-03**  
Topaz  
Longitud 4.0 cm



**CL-04**  
Nuevos



**CL-07**  
Universal  
Longitud 6.0 cm



**CL-15**  
F-350  
Longitud 5.5 cm





# CALIPER

AUTO - CAMIONETA

**828**

**Seguro P/Balatas**

F-150

F-250

F-350

(CORTO)



**828-A**

**Seguro P/Balatas**

F-150

F-250

F-350

(LARGO)



## NISSAN

**CL-08**

Tsuru III

Longitud 2.7 cm



**CL-10**

Ichivan

Longitud 6.2 cm



**CL-11**

Tsuru I

Tsuru II



**CL-12**

Tsuru III



NUEVO



PROXIMAMENTE

## VOLKSWAGEN

**CL-05**

Golf

Jetta

Longitud 5.0 cm



NUEVO



PROXIMAMENTE

NUEVO



PROXIMAMENTE



# CARDANES

AUTO - CAMIONETA



**MERCEDES BENZ  
CAMIONES DINA**

**Balero 88512**

**868-B**  
Completo

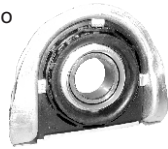

**868**  
Herraje

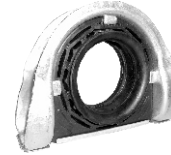

**6152**  
Goma



**CHEVROLET  
MOD. 58-65**

**Balero 6206-Z**

**149-AC-B**  
Completo



**149-AC**  
Herraje



**6149**  
Goma



**CHEVROLET  
GMC  
DINA  
DODGE  
FORD  
INTERNACIONAL  
WHITE**

**Balero 88508**

**5074-B**  
Completo

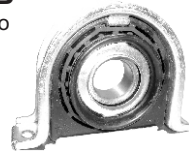

**5074**  
Herraje

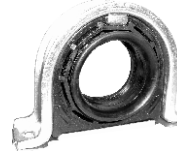

**6150**  
Goma



**5074-B-Poli**  
Completo  
en Poliuretano



**5074-B-Poli**  
Poliuretano

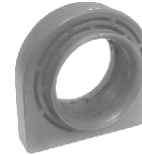

**CHEVROLET  
GMC  
DINA  
DODGE  
FORD**

**Balero 88107**

**5075-B**  
Completo

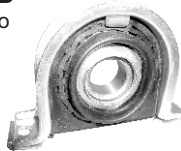

**5075**  
Herraje



**6147**  
Goma



**AUTOBUSES  
DINA 800**

**Balero 88509**

**5076-B**  
Completo

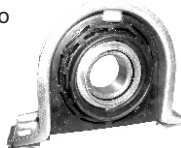

**5076**  
Herraje

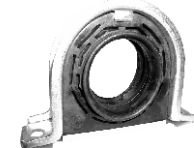

**6150-A**  
Goma



**CAMIONETAS  
CHEVROLET  
GMC  
DODGE  
FORD**

**Balero 88510**

**5077-B**  
Completo

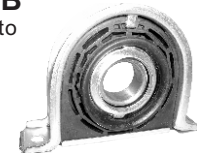

**5077**  
Herraje



**6153**  
Goma





# CARDANES

AUTO - CAMIONETA

**FORD  
RANGER  
TIPO NUEVO  
VIEJO  
MOD. 86-89**

**Balero 6206-Z**

**5078-B**  
Completo

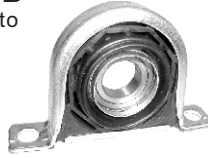

**5078**  
Herraje



**6154**  
Goma



**5078-BA**  
Tapa

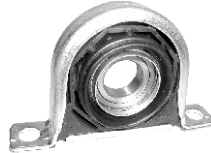

**Balero 88506 32mm.**

**NISSAN  
2.4 LTS.  
D-21**

**Balero 88508-A**

**5079-B**  
Completo

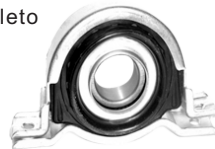

**5079**  
Herraje



**6155**  
Goma



**VARIOS**

**6148**  
Goma  
FORD: F-600  
F-750  
F-800  
DINA: 631,B661  
DODGE: 900  
P/Balero  
88107



**6151**  
Goma  
"Spicer"  
P/Balero  
88508



**1020=A6000**  
Nissan  
Pathfinder  
Hard Body  
Mod. 86-97



OE-37521-01W25

**1021=A6007**  
Mitsubishi  
Mishty  
Mod. 90-96



OE-MB000-815

**A8473**  
Nissan  
Pathfinder  
4WD



OE-37521-36625

**A8474**  
Nissan  
Maxima  
Pathfinder  
Pick Up 2WD  
Mod. 82-95



**A8475**  
Nissan  
Pathfinder  
2WD



OE-37521-B9500

**A8626**  
BMW  
M5, M6  
535i, 533i  
633csi,  
635csi

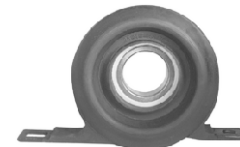

# CASSETAS / CHASIS

AUTO - CAMIONETA



## CHEVROLET

**CH-367**

Autos  
Delantero



**CH-368**

Autos  
Traseros  
"608"

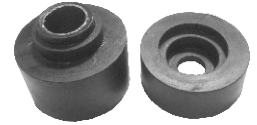

**CH-372**

Camionetas  
Delantero



**CH-373**

Camionetas  
Trasero



**CH-374**

Celebriy  
Citation  
Cutlass  
Delantero



**CH-375**

Celebriy  
Citation  
Cutlass  
Trasero

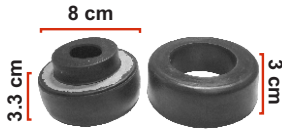

## DODGE

**CH-376**

(CHICO)  
Autos  
Delantero  
Ovalado

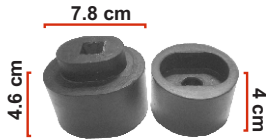

**CH-377**

(GRANDE)  
Autos  
Trasero  
Ovalado



**CH-378**

Camionetas  
Trasero  
"603"



**CH-379**

Camionetas  
Delantero

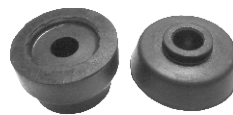

**CH-381**

Camionetas Ram  
Delantero

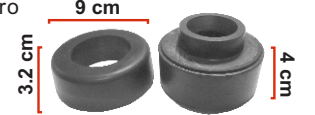

**CH-382**

Camionetas Ram  
Trasero

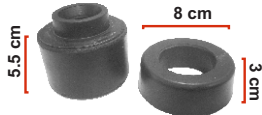



# CASSETAS / CHASIS

AUTO - CAMIONETA

F O R D

**CH-369**  
Camionetas  
Delantero  
"605"



**CH-369**  
Camionetas  
Trasero  
"601"



**CH-371**  
(PUNTA)  
Camionetas  
Delantero  
"602"

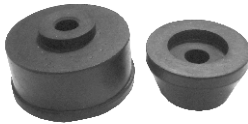

N I S S A N

**CH-365**  
Datsun  
Nissan  
Camionetas  
Delantero

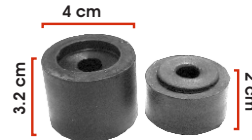

**CH-366**  
Datsun  
Nissan  
Camionetas  
Trasero



V O L K S W A G E N

**CH-612**  
Brasilia  
Sedán



U N I V E R S A L

**198**  
Altura: 13/16"  
Exterior: 1 1/2"  
Interior: 3/8"



**199**  
Altura: 1"  
Exterior: 2"  
Interior: 7/8"



**308**  
Altura: 5/8"  
Exterior: 2 15/16"  
Interior: 1/2"



**324**  
Altura: 1 1/8"  
Exterior: 2 5/8"  
Interior: 3/4"



**325**  
Altura: 3/4"  
Exterior: 2 1/4"  
Interior: 3/4"



**326**  
Altura: 7/8"  
Exterior: 2 1/2"  
Interior: 3/4"



**336**  
Altura: 5/8"  
Exterior: 2 3/8"  
Interior: 1/2"



**337**  
Altura: 7/16"  
Exterior: 1 1/2"  
Interior: 3/8"



# CASETAS / CHASIS

AUTO - CAMIONETA



UNIVERSAL

348

Altura: 2 1/2"  
Exterior: 3"  
Interior: 3/4"



349

Altura: 1"  
Exterior: 3"  
Interior: 3/4"



593

Exterior: 3 15/16"  
Interior: 3/4"



# CALIDAD Y GARANTÍA DE EXPORTACIÓN



# FUELLES

AUTO - CAMIONETA

## CHEVROLET

**7039**  
Cavalier  
6 Cil.  
Mod. 87-94



## CHRYSLER

**7044**  
Shadow  
Spirit



**7048**  
Dart  
Volare  
Línea K



## DATSUN

**527-V**  
Mod. 65-68



**758**  
Mod. 74-78



**771**  
Pick Up  
Mod. 78-83  
Tsuru GS



**7058**  
Mod. 69-73



## DODGE

**772**  
Camioneta



## FORD

**776**  
Camioneta



**776-B**  
Camioneta  
F-600



**7041**  
Camioneta  
F-250  
F-350  
F-400  
Lobo



**7046**  
Fairmont  
Mustang  
C/Arillo  
Cromado

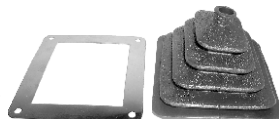

UNIVERSAL

**7052**  
F-250  
F-350  
Mod. 92-98



# FUELLES

AUTO - CAMIONETA



## FORD

**7060**  
Pick Up  
F-150  
F-250  
Mod. 00-05



## NISSAN

**771-A**  
Pick Up  
2.4 Lts.  
Mod. 93-03

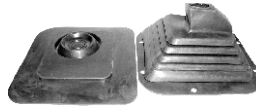

**783**  
Tsuru II  
Mod. 84-86



**783-A**  
Tsuru II  
C/entradas



**822**  
Tsuru I y III  
Tsuru GS  
Mod. 87-92



**822-A**  
Tsuru I y III  
Tsuru GST  
Mod. 87-92



**7051**  
Urvan



## RENAULT

**7049**  
Auto  
(Viejos)



## VOLKSWAGEN

**5072**  
Combi



**5072-A**  
Sedan



**5073**  
Sedan  
Cubre Freno  
de  
Estacionamiento



**7040**  
Pointer  
(Largo)



**7040-A**  
Pointer  
Palanca  
(Corto)



**7047**  
Golf  
Jetta A1



**7047-A**  
Atlantic  
Caribe





# FUELLES

AUTO - CAMIONETA

V A R I O S

**759**  
*Kenworth*  
(Viejo)  
*Dina*  
Tracto Camión



**759-A**  
*Kenworth*  
(Nuevo)



**759-B**  
Mercedes Benz



**764**  
*Dina*  
con Dual  
(Nuevo)



**764-A**  
*Dina*  
(Nuevo)



**770**  
*Auto Car*  
Tractor



**770-A**  
*White*  
Tracto Camión



**776-A**  
*Famsa*  
Camión



**7035**  
*Kenworth*  
T-800



**7045**  
*Universal*  
(Redondo)



**7053**  
*Mercedes Benz*  
Camión Urbano



# CALIDAD Y GARANTÍA DE EXPORTACIÓN



# GOLLETES

AUTO - CAMIONETA



## CHRYSLER

**515-A**  
Autos  
DODGE



**515-C**  
Autos "K"



**515-E**  
Shadow  
Spirit



**515-M**  
Autos "K"  
(GRANDE)



**516-C**  
(GRANDE)



## FORD

**515-V**  
Antiguo



## VOLKSWAGEN

**515-B**  
Sedan



**516-D1**  
Combi 1800  
Diámetro: 1 3/4"



**516-D2**  
Combi 1600  
Diámetro: 1 3/4"



**853-B**  
Combi  
Dona  
Suspensión  
Lisa



**853-D**  
Combi  
Dona  
Suspensión  
Astriada



## UNIVERSAL

**516-V**  
Universal





## GOMAS ALTERNADOR

AUTO - CAMIONETA

**20400**  
Chevrolet  
Chevy



**20400-A**  
Chrysler



**20400-B**  
Chrysler  
Dart K



## GOMAS AMORTIGUADOR

AUTO - CAMIONETA

CHEVROLET

**3507**  
Carrete  
Altura: 35 mm  
(CÓNICO DOBLE)



CHRYSLER

**5064-A**  
Dart  
VARILLA



DATSUN

**3188**  
Carrete  
Altura: 43 mm  
(GRANDE)



VOLKSWAGEN

**3505**  
Carrete  
Altura 26 mm



**3505-A**  
Carrete



**3523**  
Goma C/Buje  
Eurovan



**3025**  
Cilíndrica  
Altura: 22 mm



# GOMAS AMORTIGUADOR

AUTO - CAMIONETA



## V A R I O S

**3025**  
Cilíndrica  
Altura: 22 mm.



**3180**  
Altura: 28 mm.



**3186**  
Carrete  
(Chico)  
Altura: 39 mm.



**3500**  
Dina  
Camión



**3501**  
Dina



**3502**  
Somex



**3503-A**  
Interior: 3/4"  
VOLVO



**3508**  
P/Horquilla  
Dina  
Mod. 80-87  
Sobre Medidas



**3509**  
Scania  
Autobús



**3512**  
(Chica)  
Autobús  
Camión  
Mercedes Benz



**3513**  
(Grande)  
Autobús  
Camión  
Mercedes Benz



**3514**  
(Mediana)  
Autobús  
Camión  
Mercedes Benz



**8024**  
Cilíndrica  
Altura: 23 mm.



**8045-A**  
Altura: 20 mm.  
P/Gabriel



# CALIDAD Y GARANTÍA DE EXPORTACIÓN



# GOMAS COFRE

AUTO - CAMIONETA

## CHEVROLET

**CF-11**  
Lateral  
Auto



**CF-17**  
Lateral  
Celebrity



**CF-20**  
Lateral  
Cavalier  
V6



**CF-26**  
Lateral  
Chevy

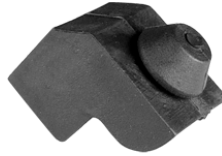

**CF-28**  
Lateral  
Cavalier  
L4



**CF-30**  
Lateral  
Pontiac



**CF-34**  
Lateral  
Blazer



**CF-40**  
Lateral  
Pontiac  
Grand Prix



**CF-41**  
Lateral  
Pontiac  
Sunfire



**CF-273**  
Lateral  
"Antiguo"



**CF-336**  
Lateral  
Astra



**CF-377**  
Lateral  
Malibú



## CHRYSLER

**CF-14**  
Lateral  
Dart K



**CF-22**  
Lateral  
Spirit



## DAT S U N

**CF-09**  
Lateral  
"Viejo"



**CF-10**  
Lateral  
"Nuevo"



# GOMAS COFRE

AUTO - CAMIONETA



## DODGE

**CF-12**  
Lateral  
Autos



**CF-23**  
Lateral  
"Flecha"

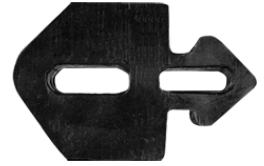

**CF-29**  
Lateral  
Camioneta



**CF-32**  
Lateral  
"Plano"



## FORD

**CF-07**  
Lateral  
Camionetas



**CF-08**  
Lateral  
Autos



**CF-21**  
Lateral  
Cougar



**CF-25**  
Lateral  
F-150



**CF-27**  
Lateral  
"Ciego"



**CF-29**  
Lateral  
F-350



**CF-36**  
Lateral  
F-250



**CF-38**  
Lateral  
Fiesta



**CF-39**  
Lateral  
Topaz



**CF-272**  
Lateral  
"Antiguo"



**CF-311**  
Lateral  
Camioneta  
Doble Cabina



**CF-390**  
Lateral  
F-150 XL





# GOMAS COFRE

AUTO - CAMIONETA

**JEEP  
CHRYSLER**

**CF-33**  
Lateral  
*Cheyenne*



**CF-312**  
Lateral  
*Cherokee*



**N I S S A N**

**CF-16**  
Lateral  
*Autos*



**CF-24**  
Lateral  
*Autos*



**R A M B L E R**

**CF-13**  
Lateral  
*Rambler*



**V O L K S W A G E N**

**CF-15**  
Lateral  
*Caribe*



**CF-18**  
Lateral  
*Golf*



**CF-19**  
Lateral  
*Jetta*



**CF-37**  
Lateral  
*Jetta A3*



**CF-397**  
Lateral  
*Corsar*



**V A R I O S**

**CF-31**  
Lateral  
*Doble Pata*

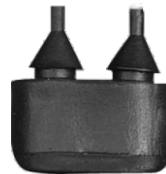

**CF-35**  
Lateral  
*Universal  
CHICO  
"Corita"*



# GOMAS DIRECCIÓN

AUTO - CAMIONETA



## CHEVROLET

**GD-10**  
Eurosport  
Cutlass



**GD-61**  
Cutlass



## CHRYSLER

**GD-03**  
Goma Cremallera  
P/Dirección  
Hidráulica  
Dart K  
Mod. 89-90



**GD-55**  
Cirrus  
Stratus  
Der.

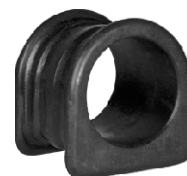

**GD-56**  
Cirrus  
Intrepid  
Stratus  
Izq.  
Mod. 97-00



## FORD

**GD-06**  
Topaz  
Std.  
Der.



**GD-15**  
Barra  
Dirección  
Hidráulica  
Topaz  
Der.  
Mod. 90-94



**GD-16**  
Barra  
Dirección  
Topaz  
Der.  
Mod. 84-89



**GD-17**  
Barra  
Dirección  
Topaz  
Std.  
Der.



**GD-18**  
Barra  
Dirección  
Hidráulica  
Topaz  
Std.  
Der.  
Mod. 90-92



**GD-42**  
Barra  
Dirección  
Hidráulica  
Topaz



**GD-43**  
Barra  
Dirección  
Contur  
Mystique  
Der.



**GD-44**  
Barra  
Dirección  
Contur  
Mystique  
Izq.



## NISSAN

**GD-14**  
Barra  
Dirección  
Hidráulica  
Tsuru I  
Tsuru II  
Der.



**GD-19**  
Barra  
Dirección  
Tsuru II





# GOMAS DIRECCIÓN

AUTO - CAMIONETA

**GD-21**  
Barra  
Dirección  
Tsuru III  
Izq.



**GD-45**  
Goma  
Cremallera  
Tsuru II  
Std.



**GD-49**  
Barra  
Dirección  
Hidráulica  
Tsuru II  
Izq.



**GD-50**  
Barra  
Dirección  
Hidráulica  
Tsuru III  
Der.



**GD-54**  
Barra  
Dirección  
Tsuru III  
Der.  
(Reforzada)



**GD-60**  
Barra  
Dirección  
Tsuru II  
(Reforzada  
C/Hoyos)



## VOLKSWAGEN

**GD-20**  
Barra  
Dirección  
Atlantic  
Caribe  
Izq.



**GD-52**  
Barra  
Dirección  
Hidráulica  
Caribe



**GD-59**  
Barra  
Dirección  
Hidráulica  
Golf  
Jetta A2  
Mod. 84-92



**GD-62**  
Eurovan  
(Grande)



**GD-91**  
Eurovan  
Der.  
(Hoyo Grande)  
Mod. TODOS



# CALIDAD Y GARANTÍA



# GOMAS ESCAPE

AUTO - CAMIONETA



## CHEVROLET

**849**  
Cavalier  
Mod. 87-95



**849-A**  
Century  
Cutlass



**849-M**  
*Goma Intermedia*  
Cavalier  
Mod. 87-95



**928**  
Chevy  
Monza  
(TODOS)



**954**  
Chevy  
Pick Up



## CHRYSLER

**813-A**  
*Goma Intermedia*  
Tipo K  
(TODOS)



**815**  
*Goma P/Silenciador*  
Tipo K  
(TODOS)

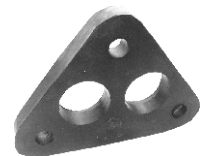

**831-A**  
Neón  
Mod. 00-04



**831-B**  
Dodge Ram



**844**  
Lebaron  
New Yorker  
Shadow  
Spirit  
Phantom



**844-A**  
Spirit



**861-A**  
Neón  
Mod. 94-99

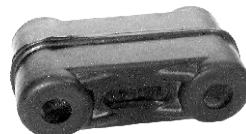

**955**  
Cirrus  
Stratus  
(TODOS)



## FORD

**859-A**  
Courier  
Fiesta



**928-C**  
F-150  
F-250  
F-350  
Lobo  
Mod. 00-04

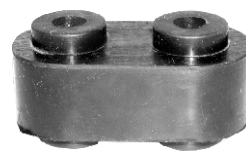

**955-A**  
F-150  
F-250  
Lobo  
Mod. 00-04





# GOMAS ESCAPE

AUTO - CAMIONETA

## MAZDA

**A2065**  
Mazda 6

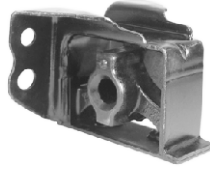

**A3913**  
Mazda 6



## NISSAN

**830**  
Tsuru II  
Tsuru III



**830-A**  
Tsuru II  
Tsuru GS

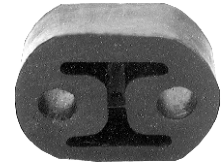

**830-B**  
Tsuru I  
Tsuru II



**927**  
Sentra



**1055**  
Platina



**1060**  
Platina



## RENAULT

**713**  
Renault  
"Viejo"



**736**  
Renault  
"Viejo"



**859-B**  
Soporte  
Trasero  
Megane



**1055**  
Clio



**1060**  
Clio

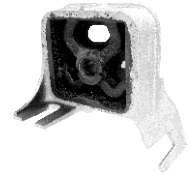

**A584**  
Tubo de Escape  
Trasero  
Kangoo



**A1570**  
Clio Sport



**A4164**  
Soporte  
Clio

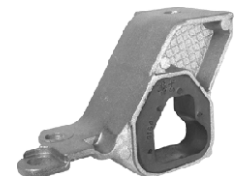

# GOMAS ESCAPE

AUTO - CAMIONETA



## VOLKSWAGEN

**582**

*Gruesa Universal  
Dona P/Tubo*

Atlantic  
Caribe  
Golf  
Jetta A1



**757**

*Galleta  
P/ Silenciador*  
Atlantic  
Caribe  
Corsar  
Sedán



**849-B**

Pointer



**859**

Golf  
(*TODOS*)  
Jetta  
Mod. 87-92



**861**

Jetta  
Mod. 93-95



**883**

Golf  
Jetta  
Mod. 94-98  
Corto



**883-A**

Golf  
Jetta  
Mod. 94-98  
Largo



**886**

Golf  
Jetta  
Mod. 95-98

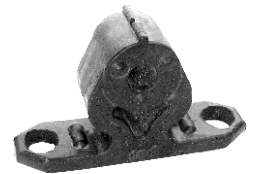

**1124-A**

*Soporte  
(Silicón)*  
Golf  
Jetta A4  
Nuevo Beetle



# GOMAS MUELLE

AUTO - CAMIONETA

## CHEVROLET

**9087**

Chevy  
Nova



## DATSUM

**20400**

Datsun  
Trasero



**20401**

*Astriada*  
Datsun





# GOMAS MUELLE

AUTO - CAMIONETA

**20403**  
Astriada  
Datsun  
1 3/4" X 5/8"



**20403-A**  
Lisa  
Datsun  
1 3/4" X 5/8"



**D O D G E**

**9290**  
Valiant  
7/8" X 7/16"



**F O R D**

**9084**  
F-200

**9085**  
Falcon



**9088**  
Ford  
1" X 9/16"



**9088-A**  
Ford  
1" X 1/2"



**9572**  
F-200  
1 1/4" X 1/2"



**9573**  
Falcon



**N I S S A N**

**853**  
Cubre  
Percha  
Ichi Van



**20405**  
Lisa  
1 1/4" X 5/8"



**20405-A**  
Lisa  
1 1/4" X 3/4"



**20406**  
Lisa  
1 5/8" X 5/8"



**20406-A**  
Astriada  
Mediana  
Int: 5/8"



# GOMAS MUELLE

AUTO - CAMIONETA



V A R I O S

**795**  
Percha  
Delantero



**796**  
Percha  
Trasero



**9082**  
Goma  
P/Diamond



**9082-A**  
Goma  
P/Buje  
Suspensión  
Remolque  
Kenworth  
Rayco



# GOMAS VARIAS

AUTO - CAMIONETA

V A R I O S

**530**  
Cubre Polvo  
Excentrico  
Suspensión  
Dina  
Mod. 72-90



**530-V**  
Cubre Polvo  
Cruzeta



**608-Dual**  
Duál Eléctrico



**619**  
Flector  
Volkswagen  
Sedán



**619-F**  
Paso Guía  
Radiador  
GMC



**685\***  
Paso Guía  
Radiador  
GMC



**785\***  
Goma Multiple  
Abierta  
Volkswagen  
Sedán



**853-C**  
Dona Suspensión  
Lisa Grande  
Volkswagen  
Combi



**2314**  
Goma Canilla  
Suspensión  
Sultana



**2315**  
Goma Canilla  
Suspensión  
Somex  
X-2000  
X-3000



**2316**  
Goma Canilla  
Suspensión  
Somex  
X-5000





## GOMAS VARIAS

AUTO - CAMIONETA

**2317**  
**Goma Canilla**  
**Suspensión**  
Mercedes Benz  
Autobús



**3510**  
**Múltiple**  
**Cerrada**  
Volkswagen



**5200**  
**Soporte**  
**Antivibración**  
Dina  
Navistar  
Mod. 81-87  
Interior: 5/8"



**5200-A**  
**Soporte**  
**Antivibración**  
Autocar  
Mod. 81-87  
Interior: 7/8"



**5208**  
**Soporte**  
**P/Cabina**  
Kenworth  
Camarote  
KW W900



**5209**  
**Hongo**  
**P/Bisagra**  
Kenworth  
Tracto



# CALIDAD Y GARANTÍA DE EXPORTACIÓN

# P E D A L E S

AUTO - CAMIONETA



## CHEVROLET

**7011**  
Freno Automático "Viejo"

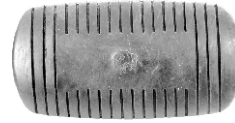

Pieza

**7014**  
Clutch Freno Camión GMC



2 Piezas

**7026**  
Clutch Freno Chevy Nova C-10, C-15, C-20 y C-30



2 Piezas

**7036**  
Acelerador Mod. 54-60



Pieza

**7050**  
Acelerador Camionetas



Pieza

**7057**  
Freno de Estacionamiento



Pieza

**7063**  
Clutch Freno Chevy Nova



2 Piezas

**7071**  
Clutch Freno Cutlass Celebrity X-11



2 Piezas

**7081**  
Clutch Freno Blazer S-10 Pick Up



2 Piezas

**7082**  
Clutch Freno Chevy Pop Swing Joy Monza



2 Piezas



## C H R Y S L E R

**7001-SH**  
Freno de Estacionamiento Shadow



Pieza

**7016**  
Clutch Freno Stratus

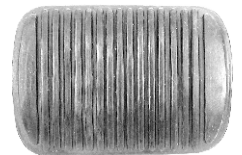

2 Piezas

**7056-A**  
Freno Automático

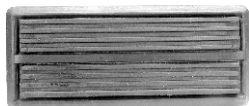

Pieza

**7061**  
Clutch Freno Dart Valiant

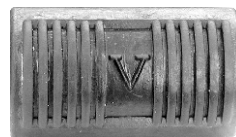

2 Piezas

**7086**  
Clutch Freno Atos



2 Piezas

**7091**  
Clutch Freno Line K (TODOS)

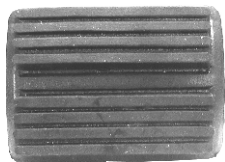

2 Piezas





# P E D A L E S

AUTO - CAMIONETA

## D A T S U N

**7027**  
*Clutch*  
*Freno*  
Mod. 74-78

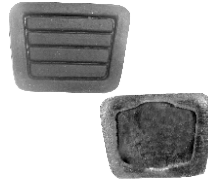

**2 Piezas**

**7062**  
*Cubre*  
*Acelerador*



**Pieza**

## D O D G E C H R Y S L E R

**7001-D**  
*Freno de*  
*Estacionamiento*



**Pieza**

**7028**  
*Clutch*  
*Freno*  
Valiant

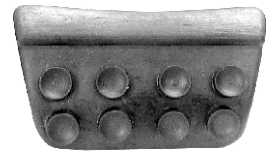

**2 Piezas**

**7056**  
*Clutch*  
*Freno*  
Camionetas

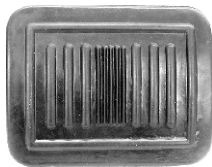

**2 Piezas**

**7076**  
*Freno*  
*Automático*  
Ram Charger  
(TODOS)  
Pick Up



**Pieza**



## F O R D

**7002**  
*Clutch*  
*Freno*  
F-150, F-200  
F-250, F.350  
Falcon



**2 Piezas**

**7010**  
*Freno*  
*Automático*  
Focus

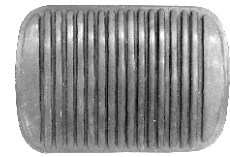

**Pieza**

**7012**  
*Clutch*  
*Freno*  
Mercury

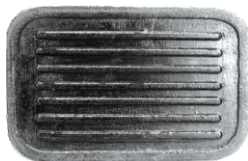

**2 Piezas**

**7018**  
*Clutch*  
*Freno*  
Camión



**2 Piezas**

**7029**  
*Clutch*  
*Freno*  
Mustang  
Maverick  
Mod. 65-77



**Juego 2 Piezas**

**7064**  
*Freno*  
*Automático*  
Mustang



**Pieza**

**7068**  
*Clutch*  
*Freno*  
Fairmont  
Mustang  
Mod. 78-83



**2 Piezas**

**7073**  
*Freno*  
*Automático*  
Camionetas  
Pick Up  
F-150, F-200  
F-350



**Pieza**

**7089**  
*Clutch*  
*Freno*  
Ranger

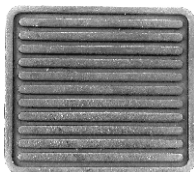

**2 Piezas**





# P E D A L E S

AUTO - CAMIONETA



## J E E P C H R Y S L E R

**7005**  
Clutch  
Freno  
Wagonner



2 Piezas

## N I S S A N

**7067**  
Clutch  
Freno  
Tsuru I



**7074**  
Acelerador  
Tsuru I



2 Piezas

Pieza

**7079**  
Clutch  
Freno  
Tsuru III  
Tsuru GST  
Sentra



2 Piezas

**7080**  
Clutch  
Freno  
Ichi Van  
(TODOS)



2 Piezas

**7087**  
Clutch  
Freno  
Platina



2 Piezas

## R A M B L E R

**7003**  
Clutch  
Freno  
Gremlin



2 Piezas

**7059**  
Clutch  
Freno  
Universal



2 Piezas

**7064**  
Freno  
Automático  
Vam

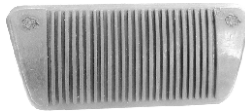

Pieza



## R E N A U L T

**7006**  
Clutch  
Freno  
R-12



2 Piezas

**7008**  
Clutch  
Freno  
R-18



2 Piezas

**7087**  
Clutch  
Freno  
Clio



2 Piezas





# P E D A L E S

AUTO - CAMIONETA

## VOLKSWAGEN

**7054**  
**Cubre**  
**Acelerador**  
Brasilia  
Combi



**Pieza**

**7069**  
**Cubre**  
**Estribo**  
Combi  
Der. Izq

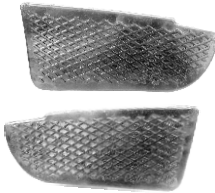

**Juego 2 Piezas**

**7072**  
**Acelerador**  
Atlantic  
Caribe



**Pieza**

**7084**  
**Freno**  
**Automático**  
Golf  
Jetta A3



**Pieza**

**7013**  
**Acelerador**  
**Universal**  
Atlantic  
Caribe

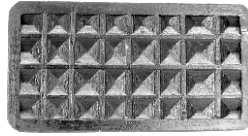

**Pieza**

**7066**  
**Clutch**  
**Freno**  
Atlantic  
Caribe



**2 Piezas**

**7070**  
**Clutch**  
**Freno**  
Corsar  
Golf  
Jetta A4



**2 Piezas**

**7030**  
**Clutch**  
**Freno**  
Brasilia  
Combi  
Sedán



**2 Piezas**

**7066-A**  
**Freno**  
**Automático**  
Atlantic  
Caribe

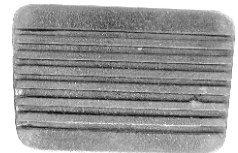

**2 Piezas**

**7070-A**  
**Clutch**  
**Freno**  
Corsar  
Golf  
Jetta A4  
Mod. 93-95



**7083**  
**Freno**  
**Automático**  
Golf  
Jetta A2



**Pieza**

**7078**  
**Cubre**  
**Acelerador**  
Combi  
Sedán



**Pieza**

**7084-A**  
**Freno**  
**Automático**  
Golf  
Jetta A4

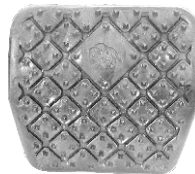

**Pieza**



## V A R I O S

**7015**  
**Clutch**  
**Freno**  
Dina  
Internacional

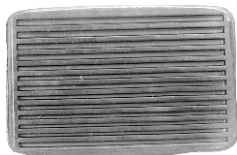

**2 Piezas**

**7037**  
**Acelerador**  
**Universal**



**Pieza**

**7038**  
**Acelerador**  
Dina



**Pieza**

**7000-KW**  
**Clutch**  
Kenworth



**Pieza**

**7009\***  
**Clutch**  
**Freno**  
Dina  
Internacional  
Olimpico  
Somex

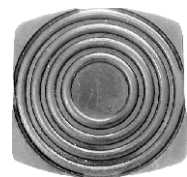

**2 Piezas**

# PEDALES

AUTO - CAMIONETA



**7042**  
**Cubre**  
**Acelerador**  
Camión

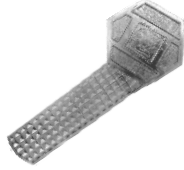

*Pieza*

**7043**  
**Cubre**  
**Acelerador**  
Camionetas  
Universal



*Pieza*

**7055**  
**Freno de**  
**Aire**  
Dina



*Pieza*

**7077**  
**Clutch**  
**Freno**  
Mercedes  
Benz  
Autobús



*2 Piezas*

**7088**  
**Clutch**  
**Freno**  
Mercedes  
Benz  
Camión Urbano



*2 Piezas*

**7090**  
**Clutch**  
**Freno**  
Mercedes  
Benz  
Camión  
(Grande)  
*2 Pieza*



**7090**  
**Acelerador**  
**Flotante**  
**Universal**



*Pieza*



MR

## CALIDAD Y GARANTÍA DE EXPORTACIÓN

Autopartes **Hule - Metal**



# GOMAS PUNTERÍAS

AUTO - CAMIONETA

## CHEVROLET

**20404-B**  
Punterías  
Camión



**20404-CH**  
Punterías  
Autos



**20404-CU**  
Punterías  
Cutlass



## DODGE

**20404-D**  
Punterías



**20404-R**  
Punterías



## FORD

**20404-FC**  
Punterías  
Camioneta



**20404-FT**  
Punterías  
Topaz



## NISSAN

**612-N**  
Tapón de  
Aceite



**20404-E**  
Punterías



## RAMBLER

**20404-R**  
Punterías



## VARIOS

**522-VW**  
Tapón de Agua  
Golf  
Jetta  
Diámetro: 3/8"



# GOMAS TAPON DE AGUA

AUTO - CAMIONETA



## VARIOS

**522-V**  
Tapón  
Bomba de Agua  
Diámetro: 5/8"



**613-V**  
Tapón  
Bomba de Agua  
Diámetro: 3/4"



**614-V**  
Punterías  
1"



**617-V**  
Tapón  
Bomba de Agua  
Diámetro: 7/8"



**751**  
Punterías  
Dina  
Tracto Camión



# GOMAS RADIADOR

AUTO - CAMIONETA

## CHEVROLET

**RA-3**  
"Viejo"



**RA-7**  
Camionetas  
Microbús



## CHRYSLER

**RA-6**  
Autos



**RA-8**  
"Grande"  
Ram



**RA-18**  
Superior  
Cirrus  
Stratus



**RA-19**  
Inferior  
Cirrus  
Stratus



**RA-24**  
Neón



## FORD

**253-A**  
Soporte  
Topaz



**RA-2**  
Autos





# GOMAS RADIADOR

AUTO - CAMIONETA

**RA-4**  
LTD



**RA-11**  
Camión



**RA-20**  
Superior  
Escort



**RA-21**  
Contur  
Mistique



**RA-23**  
Ka



**RA-25**  
Inferior  
Escort



**RA-26**  
Fiesta



## N I S S A N

**RA-9**  
Alto  
Tsuru I  
Tsuru II



**RA-10**  
Bajo  
Tsuru III



**RA-12**  
Complemento  
Tsuru I  
Tsuru II  
Tsuru III



**RA-15**  
Superior  
Tsuru I



**RA-22**  
Inferior  
Tsuru III



**RA-500**  
Inferior  
Sentra



## VOLKSWAGEN

**RA-13**  
Golf  
Jetta A2  
Mod. 89-94



**RA-14**  
Golf  
Jetta A3  
Mod. 95-99



# GOMAS RADIADOR

AUTO - CAMIONETA



MR

V A R I O S

**RA-1**  
Bajo  
Universal



**RA-5**  
Alto  
Universal



# GOMAS REBOTE

AUTO - CAMIONETA

CHEVROLET

**RE-33**  
Trasero  
Chevy



CHRYSLER

**RE-20**  
Amortiguador  
Dart K



**RE-29**  
(Tope)  
Suspensión  
Voyager



**RE-30**  
Voyager  
(TODOS)



**RE-32**  
Atos  
Trasero



F O R D

**RE-27**  
C/Cubre Polvos  
P/Amortiguador  
Topaz





# GOMAS REBOTE

AUTO - CAMIONETA

**N I S S A N**

**RE-28**  
C/Cubre Polvos  
P/Amortiguador  
Tsuru II



**RE-34**  
C/Cubre Polvos  
P/Amortiguador  
Platina



**3515-A**  
C/Cubre Polvos  
P/Amortiguador  
Tsuru III  
Delantero



**3515-B**  
C/Cubre Polvos  
P/Amortiguador  
Tsuru III  
Delantero



**3515-D**  
C/Cubre Polvos  
P/Amortiguador  
Sentra



**3515-F**  
Copa Chica  
Tsuru II  
Delantero



**3515-H**  
Tsuru III  
Trasero



**R E N A U L T**

**RE-34**  
C/Cubre Polvos  
P/Amortiguador  
Clio



**V O L K S W A G E N**

**RE-21**  
Amortiguador  
Caribe  
Delantero



**RE-22**  
Amortiguador  
Caribe  
Trasero



**RE-23**  
Amortiguador  
Sedan  
Delantero



**RE-24**  
Amortiguador  
Golf  
Jetta  
Delantero



**RE-25**  
Amortiguador  
Golf  
Jetta  
Trasero



**RE-26**  
Suspensión  
Combi



**RE-35**  
(Largo)  
Golf  
Jetta  
Trasero



**3515-C**  
Pointer  
Delantero





# GOMAS REBOTE

AUTO - CAMIONETA



**3515-G**  
Pointer  
Trasero



# CUBRE POLVO ROTULAS

AUTO - CAMIONETA

## CHEVROLET

**R-2**  
Autos  
Pick Up



**R-7**  
Autos  
Pick Up



**R-9**  
Cavalier



**R-10**  
Pick Up



## DODGE

**R-2**  
Autos  
Pick Up



**R-5**  
Pick Up  
Mod. 73-82



**R-14**  
Pick Up



## FORD

**R-3**  
Topaz



**R-5**  
Pick Up  
Mod. 73-83





# CUBRE POLVO RÓTULAS

AUTO - CAMIONETA

**R-6**  
Fairmont  
Mustang



**R-7**  
Autos  
Pick Up



**VOLKSWAGEN**

**R-1**  
Sedán  
1500



**R-2**  
Autos  
Pick Up



**R-12**  
Sedán  
1600



**R-13**  
Combi



**V A R I O S**

**R-1A**  
Universal



**R-4**  
Universal



**R-8**  
Universal



**R-11**  
Universal



## CALIDAD Y GARANTÍA DE EXPORTACIÓN

# NIVELADORES TOPE COFRE

AUTO - CAMIONETA



**B M W**

**T-329**  
*Tornillo Nivelador*  
Cofre



**C H E V R O L E T**

**T-56**  
*Tornillo Nivelador*  
Cofre  
Chevy



**T-65**  
*Tornillo Nivelador*  
Cofre  
Monza



**T-70**  
*Tornillo Nivelador*  
Cofre  
Pontiac  
Grand Prix



**T-72**  
*Tornillo Nivelador*  
Cofre  
Cutlass



**T-75**  
*Tornillo Nivelador*  
Cofre  
Suburban



**T-119**  
*Tornillo Nivelador*  
Cofre



**T-120**  
*Tornillo Nivelador*  
Cofre



**T-330**  
*Tornillo Nivelador*  
Cofre  
Silhouette



**T-341**  
*Tornillo Nivelador*  
Cofre  
Camionetas Nuevas



**C H R Y S L E R**

**T-67**  
*Tornillo Nivelador*  
Cofre  
Universal



**T-145**  
*Tornillo Nivelador*  
Cofre  
Linea K



**T-339**  
*Tornillo Nivelador*  
Cajuela  
Neón



**T-450**  
*Tornillo Nivelador*  
Cajuela  
Neón



**T-454**  
*Tornillo Nivelador*  
Cofre  
Verna





# NIVELADORES TOPE COFRE

AUTO - CAMIONETA

D A T S U N

**T-86-B**  
*Tornillo Nivelador*  
Datsun 1/4"



**T-86-BC**  
*Goma*  
*Tornillo Nivelador*  
Repuesto T-86-B



D O D G E

**T-392**  
*Tornillo Nivelador*  
*Cajuela y Cofre*  
Atos



F O R D

**T-58**  
*Tornillo Nivelador*  
*Cofre*  
Camionetas  
Windstar



**T-59**  
*Tornillo Nivelador*  
*Cofre*  
Autos Modernos



**T-68**  
*Tornillo Nivelador*  
*Cofre*  
Focus



**T-86-A**  
*Tornillo Nivelador*  
*Cofre*



**T-86-R**  
*Goma*  
*Tornillo Nivelador*  
*Cofre*  
Repuesto T-86-A



**T-340**  
*Tornillo Nivelador*  
*Cajuela*  
Focus



H O N D A

**T-338**  
*Tornillo Nivelador*  
*Puerta*  
Trasera



**T-404**  
*Tornillo Nivelador*  
*Cofre*  
Odyssey



**T-384**  
*Tornillo*  
*Nivelador*  
*Puerta*  
CR-V



# NIVELADORES TOPE COFRE

AUTO - CAMIONETA



## JEEP CHRYSLER

**T-60**  
*Tornillo Nivelador  
Cofre*  
Cherokee



**T-74**  
*Tornillo Nivelador  
Cofre*  
Cheyenne



## MITSUBISHI

**T-441**  
*Tornillo Nivelador  
Cofre*

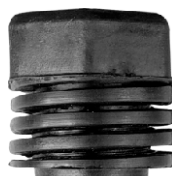

## NISSAN

**T-13**  
*Tope  
Cajuela*  
Tsuru



**T-14**  
*Tope  
Cónico  
Puerta*  
Tsuru



**T-15**  
*Tope  
Tachuela*  
Tsuru II



**T-61**  
*Tornillo Nivelador  
Cofre*  
Tsuru I  
Tsuru II



**T-64**  
*Tornillo Nivelador  
Cofre*



**T-76**  
*Tornillo Nivelador  
Cofre*  
Tsuru III



**T-85**  
*Tornillo Nivelador  
Cofre*  
Tsuru I  
Tsuru II  
Tsuru III



**T-406**  
*Tornillo Nivelador  
Cajuela*  
Almera



## VOLKSWAGEN

**T-63**  
*Tornillo Nivelador  
Cofre*  
Jetta

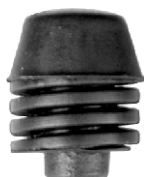

**T-69**  
*Tornillo Nivelador  
Cofre*  
Golf  
Moderno



**T-84**  
*Tornillo Nivelador  
Cofre*  
Atlantic  
Caribe  
Corsar



**T-87**  
*Tornillo Nivelador  
Cofre*  
Golf  
Jetta



**T-326**  
*Tornillo Nivelador  
Cofre*  
Dervy





# NIVELADORES TOPE COFRE

AUTO - CAMIONETA

V A R I O S

**T-6**  
Tope  
Tachuela



**T-8**  
Tope  
Tachuela



**T-9**  
Tope  
Cónico



**T-10**  
Tope  
Cónico



**T-11**  
Tope  
Cónico



**T-86**  
Tornillo Nivelador  
Cofre  
Universal  
5/16"



**T-86-G**  
Goma  
Tornillo  
Nivelador  
Cofre  
Universal  
5/16"  
Repuesto Tornillo 86



**T-118**  
Tornillo Nivelador  
Cofre



**T-434**  
Tornillo Nivelador  
Cofre  
Camiones de Volteo



**T-483**  
Tornillo Nivelador  
Cofre



**T-488**  
Tornillo Nivelador  
Cofre



**T-497**  
Tornillo Nivelador  
Cofre



**T-501**  
Tornillo Nivelador  
Cofre



# CALIDAD Y GARANTÍA DE EXPORTACIÓN

# TOPES SUSPENSIÓN

AUTO - CAMIONETA



## CHEVROLET

**816**  
Microbús



**858**  
GMC



**1112**  
Buick  
"Viejo"



**1113**  
Buick  
"Viejo"



**1117**  
GMC



**1121**



**1176**  
"Viejo"  
Delantero  
Inferior



**1180-T**  
"Viejo"  
Delantero



**5093**  
Camionetas  
Trasero



## DODGE

**5083**  
Valiant



**5083-A**  
Valiant  
Trasero  
Inferior



## FORD

**1114**



**1115**



**1119**  
Delantero  
Inferior



**1123**  
"Viejo"  
Trasero



**1179**  
Galaxie





# TOPES SUSPENSIÓN

AUTO - CAMIONETA

**1184**  
Galaxie  
F-100  
F-200  
Trasero



## N I S S A N

**853-A**  
Tope Muelle  
Ichivan



**857**  
Trasero



**878**  
Trasero  
Ichi Van  
Mod. 87-88



**889**  
Delantero  
Ichi Van  
Mod. 87-88



## R A M B L E R

**1118**  
Delantero  
Rambler



**1120**  
Rambler



## V O L K S W A G E N

**755**  
Jgo. Barra  
Torsión  
Sedán



**756**  
Jgo. Barra  
Torsión  
Combi

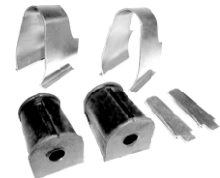

**773**  
Tope Suspensión  
Trasero  
Combi



**774**  
Tope Suspensión  
Delantero  
Combi



**870**  
P/Horquilla  
Trasero  
Caribe  
Mod. 78-85



**870-A**  
Buje Eje  
Trasero  
Caribe  
Mod. 78-85



**1186**  
Tope Suspensión  
Sedán



**1186-A**  
Tope Suspensión  
Sedán





# TOPES SUSPENSIÓN

AUTO - CAMIONETA



**1189**  
Tope Suspensión  
Trasero



**1189**  
Tope Suspensión  
Varilla  
Trasero  
Sedan



V A R I O S

**532**  
Tope  
Trasero  
Camión Dina



**925**  
Muelle  
Scania



# TOPES SORDINAS

AUTO - CAMIONETA

**SOR-1**  
Diam. Int: 9/16"  
Altura: 9/16"



**SOR-2**  
Diam. Int: 3/4"  
Altura: 7/16"



**SOR-3**  
Diam. Int: 1"  
Altura: 1/2"



**SOR-4**  
Diam. Int: 1"  
Altura: 1/2"



**SOR-5**  
Diam. Int: 1 1/8"  
Altura: 9/16"



**SOR-6**  
Diam. Int: 1 3/16"  
Altura: 5/8"



**SOR-7**  
Diam. Int: 1 5/8"  
Altura: 5/8"





# ESTABILIZADORES TORNILLOS

AUTO - CAMIONETA

## V A R I O S

**VE-1**  
*Rambler*  
7" Largo



**VE-2**  
*Chevrolet*  
8" Largo



**VE-3**  
*Ford*  
9" Largo



**VE-4**  
*Datsun*  
6" Largo



**VE-5**  
*Dodge*  
*Chrysler*  
Mod. 77-88



**VE-6**  
*Nissan*  
Tsuru I  
4 1/2" Largo



**VE-7**  
*Dodge*  
Camioneta,  
Microbús  
Mod. 75-90



**VE-8**  
*Dodge*  
Camioneta  
Dart  
Lebaron  
Monaco  
Mod. 72-81



**VE-9**  
*VW*  
Golf  
Jetta A2  
Mod. 87-98



**VE-10**  
*VW*  
Golf  
Jetta



**VE-11**  
*Nissan*  
Tsuru II  
Tsuru III



**VE-12**  
*Chrysler*  
Varilla tipo "Hueso"  
Del. P/Horquilla  
Atos (Todos)



**VE-13**  
*Nissan*  
Platina



**VE-14**  
*Nissan*  
Urban  
Rótula



**VE-15**  
*Chrysler*  
Stratus  
Rótula



**VE-16**  
*Nissan*  
2.4 Lts.  
D-21



**VE-17**  
*Nissan*  
Tsuru III  
Trasera



# VÁLVULAS

AUTO - CAMIONETA



V A R I O S

**VAL-1**  
Chrysler  
de paso p/aire  
Chica



**VAL-2**  
Chrysler  
de paso p/aire  
Mediana



**VAL-3**  
Chrysler  
de paso p/aire  
Grande



**VAL-4**  
Chrysler  
de paso p/aire  
Extra grande



**VAL-5**  
VW  
"T" p/respiración  
Golf  
Jetta



MR



# **BUFALO AHM**

---

## **CATÁLOGO**



MR

# **NUEVOS**

---

**MACHETAS**



## MACHETAS (CUBRE POLVOS) DE SANTOPRENE

### PROPIEDADES Y VENTAJAS DEL SANTOPRENE

Santoprene, es un termoplástico con propiedades muy similares al hule, diseñado para ofrecer resistencia química equivalente al Neopreno.

Los cubre polvos elaborados en este material, tienen mayor resistencia y durabilidad que otros materiales empleados como lo son el: Hule natural, Nitrilo, EPDM y Silicón.

### EFECTO SOBRE EL SANTOPRENE

#### POCO O NINGÚN EFECTO

ACEITES ANIMALES	ACEITES MINERALES	ACEITES VEGETALES	ÁCIDO BENZÓICO
ÁCIDO BÓRICO	ÁCIDO BUTÍRICO	ÁCIDO CLORHÍDRICO	ÁCIDO FOSFÓRICO
ÁCIDO TÁNICO	AMONIACO	CLORO (HUMEDO/SECO)	ETILÉNO GLICOL
FOSFATO TRISÓDICO	FORMAMIDE	GLYCERINS	HIDRÓXIDO DE SODIO
HIPOCLORITO DE SODIO	ÓXIDOS DE NITRÓGENO	OXÍGENO	PERÓXIDO DE HIDRÓGENO
SALES DE ARSÉNICO	SALES DE ANTIMONIO	SALES DE PLOMO	SULFURO DE HIDRÓGENO

#### EFECTO MENOR

ACETONA	ÁCIDO OLEICO	ÁCIDO NÍTRICO -30%	ÁCIDO SULFÚRICO
ALCOHOLES	ALCOHOL AMÍLICO	BUTANÓL	ETANOL
GRASA DE LITIO	PROPANOL	TETRAHIDROFURANO	

#### GRAVE EFECTO (NO SE RECOMIENDA)

ÁCIDO NÍTRICO -7%	BENCENO	CLOROFORMO	CLORURO DE ETILO
FREÓN	LACA	PERCLOROETILENO	QUEROSENO
TETRACLORURO DE CARBONO	TOLUENO		

## COMPARATIVO CON OTROS MATERIALES

### SANTOPRENE

TEMPERATURA  
RESISTENCIA AL ACEITE  
RESISTENCIA A ÁCIDOS  
RESISTENCIA A LA INTEMPERIE  
ABRASIÓN

**-25°C A 135°C**  
**BUENO-EXCELENTE**  
**BUENO**  
**EXCELENTE**  
**BUENO**



## **SILICÓN**

Elevada resistencia a la temperatura y excelente aislador de electricidad

TEMPERATURA	<b>-50°C A 235°C</b>
RESISTENCIA AL ACEITE	<b>REGULAR-BUENO</b>
RESISTENCIA A ÁCIDOS	<b>REGULAR-BUENO</b>
RESISTENCIA A LA INTEMPERIE	<b>EXCELENTE</b>
ABRASIÓN	<b>MALO</b>

## **HULE NEOPRENO**

Muy versátil en sus aplicaciones con grandes propiedades de resistencia a las grasas, aceites y temperaturas, así como excelente resistencia al medio ambiente, útil para la elaboración de casi todo tipo de empaques.

TEMPERATURA	<b>-25°C A 135°C</b>
RESISTENCIA AL ACEITE	<b>BUENO</b>
RESISTENCIA A ÁCIDOS	<b>REGULAR-BUENO</b>
RESISTENCIA A LA INTEMPERIE	<b>EXCELENTE</b>
ABRASIÓN	<b>BUENO-EXCELENTE</b>

## **HULE NITRILO**

Excelente para diversos tipos de empaques que tienen contacto directo con aceites y grasas. Baja resistencia al medio ambiente en especial al ozono.

TEMPERATURA	<b>-25°C A 105°C</b>
RESISTENCIA AL ACEITE	<b>EXCELENTE</b>
RESISTENCIA A ÁCIDOS	<b>REGULAR</b>
RESISTENCIA A LA INTEMPERIE	<b>MALO-REGULAR</b>
ABRASIÓN	<b>BUENO</b>

## **HULE EPDM**

Máxima resistencia a la intemperie y a las altas temperaturas. Resistente a climas extremos y al daño por ozono. resistente a solventes oxigenados como: cetonas, alcohol y aldehídos. no resiste el aceite. Ideal para la elaboración de mangueras para radiador.

TEMPERATURA	<b>-25°C A 140°C</b>
RESISTENCIA AL ACEITE	<b>MALO</b>
RESISTENCIA A ÁCIDOS	<b>BUENO</b>
RESISTENCIA A LA INTEMPERIE	<b>EXCELENTE</b>
ABRASIÓN	<b>BUENO-EXCELENTE</b>

**INFORMACIÓN PROPORCIONADA POR: V&BP SCIENTIFIC, INC (INNOVATORS IN LIQUID HANDLING ARRAYING AND MIXING)**



## CHEVROLET

CUTLASS	UBICACIÓN	MODELO	POSICIÓN	ABRAZADERA	NUM. MACHETA	No. BUFALO
	RUEDA	TODOS	DER / IZQ	30 / 86	M-382	SCG702

CAVALIER, Z24 CENTURY CUTLASS EUROSPORT	UBICACIÓN	MODELO	POSICIÓN	ABRAZADERA	NUM. MACHETA	No. BUFALO
	CAJA	TODOS	DER / IZQ	35 / 92	M-351A	SCG704

AMERICANOS	UBICACIÓN	MODELO	POSICIÓN	ABRAZADERA	NUM. MACHETA	No. BUFALO
	CAJA (TREBOL)	GRANDE	DER / IZQ	35 / 92	M-407	SCG711
	CAJA (TREBOL)	CHICO	DER / IZQ	35 / 92	M-436	SCG713

CHEVY, MONZA	UBICACIÓN	MODELO	POSICIÓN	ABRAZADERA	NUM. MACHETA	No. BUFALO
	RUEDA	TODOS		30 / 86	M-400	SCG715

CAMIONETAS 4 X 4	UBICACIÓN	MODELO	POSICIÓN	ABRAZADERA	NUM. MACHETA	No. BUFALO
	RUEDA (TREBOL)	TODOS		35 / 116		SCG717

CORSA	UBICACIÓN	MODELO	POSICIÓN	ABRAZADERA	NUM. MACHETA	No. BUFALO
	CAJA (TREBOL)		DER / IZQ	35 / 92		SCG725

MERIVA ZAFIRA	UBICACIÓN	MODELO	POSICIÓN	ABRAZADERA	NUM. MACHETA	No. BUFALO
	CAJA		DER / IZQ	35 / 116		SCG727

	UBICACIÓN	MODELO	POSICIÓN	ABRAZADERA	NUM. MACHETA	No. BUFALO

	UBICACIÓN	MODELO	POSICIÓN	ABRAZADERA	NUM. MACHETA	No. BUFALO

	UBICACIÓN	MODELO	POSICIÓN	ABRAZADERA	NUM. MACHETA	No. BUFALO

						
SCG702	SCG704	SCG711	SCG713	SCG715	SCG717	SCG725
						
SCG727	PROXIMAMENTE	PROXIMAMENTE	PROXIMAMENTE			



## CHRYSLER

SHADOW, DART VOLARE, LEBARON, NEW YORKER MAGNUM PHANTOM	UBICACIÓN	MODELO	POSICIÓN	ABRAZADERA	NUM. MACHETA	No. BUFALO
	RUEDA	TODOS			35 / 92	M-351

ATOS	UBICACIÓN	MODELO	POSICIÓN	ABRAZADERA	NUM. MACHETA	No. BUFALO
	RUEDA	00 - 05	DER / IZQ	30 / 68	M-431	SCG419
	CAJA (TREBOL)	00 - 05	DER / IZQ	30 / 74		SCG420

	UBICACIÓN	MODELO	POSICIÓN	ABRAZADERA	NUM. MACHETA	No. BUFALO

	UBICACIÓN	MODELO	POSICIÓN	ABRAZADERA	NUM. MACHETA	No. BUFALO



## FORD

COUGAR, GUIA TAURUS, THUNDERBIRD	UBICACIÓN	MODELO	POSICIÓN	ABRAZADERA	NUM. MACHETA	No. BUFALO
	CAJA	TODOS		35 / 104	M-411	SCF612
	RUEDA	TODOS		35 / 86	M-410	SCF614

FOCUS, IKON, KA, MONDEO	UBICACIÓN	MODELO	POSICIÓN	ABRAZADERA	NUM. MACHETA	No. BUFALO
	RUEDA	99 - 05		35 / 86		SCF622

	UBICACIÓN	MODELO	POSICIÓN	ABRAZADERA	NUM. MACHETA	No. BUFALO

	UBICACIÓN	MODELO	POSICIÓN	ABRAZADERA	NUM. MACHETA	No. BUFALO



## HONDA

ACCORD, CIVIC	UBICACIÓN	MODELO	POSICIÓN	ABRAZADERA	NUM. MACHETA	No. BUFALO
	CAJA (TREBOL)	97 - 02	DER / IZQ	30 / 86	M-401	SCH800

	UBICACIÓN	MODELO	POSICIÓN	ABRAZADERA	NUM. MACHETA	No. BUFALO

## NISSAN

TSURU I	UBICACIÓN	MODELO	POSICIÓN	ABRAZADERA	NUM. MACHETA	No. BUFALO
	CAJA	84 - 87	DER / IZQ	30 / 86		SCN203
	RUEDA	84 - 87	DER / IZQ	30 / 86	M-432	SCN204
	CAJA	2.0 Lts.	DER / IZQ	30 / 86	M-330A	SCN206

TSURU II TSUBAME	UBICACIÓN	MODELO	POSICIÓN	ABRAZADERA	NUM. MACHETA	No. BUFALO
	RUEDA			30 / 92	M-379	SCN205

TSURU III SENTRA	UBICACIÓN	MODELO	POSICIÓN	ABRAZADERA	NUM. MACHETA	No. BUFALO
	RUEDA			35 / 80	M-425	SCN212

SENTRA LUCCINO	UBICACIÓN	MODELO	POSICIÓN	ABRAZADERA	NUM. MACHETA	No. BUFALO
	RUEDA	98 - 04		35 / 92		SCN212

TSURU III	UBICACIÓN	MODELO	POSICIÓN	ABRAZADERA	NUM. MACHETA	No. BUFALO
	RUEDA (TREBOL)	93 - 05	DER / IZQ	35 / 92	M-434	SCN215

PLATINA	UBICACIÓN	MODELO	POSICIÓN	ABRAZADERA	NUM. MACHETA	No. BUFALO
	RUEDA (TREBOL)	02 - 05	DER / IZQ	35 / 86		SCN219

	UBICACIÓN	MODELO	POSICIÓN	ABRAZADERA	NUM. MACHETA	No. BUFALO

	 NUEVO AHM Calidad y Garantía MR					
SCH800	PROXIMAMENTE		SCN203	SCN204	SCN205	SCN206
				 NUEVO AHM Calidad y Garantía MR		
SCN212	SCN214	SCN215	SCN219	PROXIMAMENTE		



## PEUGEOT

TODOS (Std)	UBICACIÓN	MODELO	POSICIÓN	ABRAZADERA	NUM. MACHETA	No. BUFALO
	RUEDA	00 - 05	DER / IZQ	40 / 80		SCP1000
	CAJA	00 - 05	DER / IZQ	40 / 80		SCP1001

## RENAULT

R-18	UBICACIÓN	MODELO	POSICIÓN	ABRAZADERA	NUM. MACHETA	No. BUFALO
	CAJA	2.0 Lts.	DER / IZQ	30 / 80	M-330A	SCR206

R-12	UBICACIÓN	MODELO	POSICIÓN	ABRAZADERA	NUM. MACHETA	No. BUFALO
	CAJA			30 / 86	M-323	SCR307

CLIO (Std)	UBICACIÓN	MODELO	POSICIÓN	ABRAZADERA	NUM. MACHETA	No. BUFALO
	CAJA	02 - 05	DER / IZQ	50		SCR319-P

	UBICACIÓN	MODELO	POSICIÓN	ABRAZADERA	NUM. MACHETA	No. BUFALO

## TOYOTA

R-18	UBICACIÓN	MODELO	POSICIÓN	ABRAZADERA	NUM. MACHETA	No. BUFALO
	RUEDA	84 - 96	DER / IZQ	45 / 104		SCT1100

	UBICACIÓN	MODELO	POSICIÓN	ABRAZADERA	NUM. MACHETA	No. BUFALO



## VOLKSWAGEN

ATLANTIC CARIBE CORSA	UBICACIÓN	MODELO	POSICIÓN	ABRAZADERA	NUM. MACHETA	No. BUFALO
	RUEDA		DER / IZQ	30 / 86	M-304	SCVW104
	CAJA		DER / IZQ	30 / 86	M-302	SCVW105

SEDÁN BRASILIA	UBICACIÓN	MODELO	POSICIÓN	ABRAZADERA	NUM. MACHETA	No. BUFALO
	RUEDA	TODOS		56 / 98		SCVW107



## VOLSKWAGEN

<b>COMBI 1600</b>	UBICACIÓN	MODELO	POSICIÓN	ABRAZADERA	NUM. MACHETA	<b>No. BUFALO</b>
	CAJA (METÁLICA)	TODOS		35	M-767	<b>SCVW108</b>

<b>JETTA</b>	UBICACIÓN	MODELO	POSICIÓN	ABRAZADERA	NUM. MACHETA	<b>No. BUFALO</b>
	CAJA (METÁLICA)					<b>SCVW109</b>

<b>GOLF, JETTA, DERBY</b>	UBICACIÓN	MODELO	POSICIÓN	ABRAZADERA	NUM. MACHETA	<b>No. BUFALO</b>
	RUEDA	2.0 2.8 Lts. VR6		35 / 86	M-304	<b>SCVW111</b>

<b>GOLF, JETTA A4 (Dir. Hidráulica)</b>	UBICACIÓN	MODELO	POSICIÓN	ABRAZADERA	NUM. MACHETA	<b>No. BUFALO</b>
	CAJA			35 / 62		<b>SCVW113H</b>

<b>EUROVAN</b>	UBICACIÓN	MODELO	POSICIÓN	ABRAZADERA	NUM. MACHETA	<b>No. BUFALO</b>
	RUEDA	00 - 05	DER / IZQ	35 / 104		<b>SCVW114</b>

<b>JETTA A4, GOLF BORA</b>	UBICACIÓN	MODELO	POSICIÓN	ABRAZADERA	NUM. MACHETA	<b>No. BUFALO</b>
	CAJA (TREBOL)		DER / IZQ	30 / 86		<b>SCVW121</b>

<b>EUROVAN</b>	UBICACIÓN	MODELO	POSICIÓN	ABRAZADERA	NUM. MACHETA	<b>No. BUFALO</b>
	RUEDA (METÁLICA)	TODOS		30	M-409	<b>SCVW409</b>

	UBICACIÓN	MODELO	POSICIÓN	ABRAZADERA	NUM. MACHETA	<b>No. BUFALO</b>

	UBICACIÓN	MODELO	POSICIÓN	ABRAZADERA	NUM. MACHETA	<b>No. BUFALO</b>

	UBICACIÓN	MODELO	POSICIÓN	ABRAZADERA	NUM. MACHETA	<b>No. BUFALO</b>

<b>SCVW104</b>	<b>SCVW105</b>	<b>SCVW107</b>	<b>SCVW108</b>	<b>SCVW109</b>	<b>SCVW111</b>	<b>SCVW113H</b>
<b>SCVW114</b>	<b>SCVW121</b>	<b>SCVW409</b>	<b>PROXIMAMENTE</b>	<b>PROXIMAMENTE</b>	<b>PROXIMAMENTE</b>	



# ABRAZADERAS METAL

AUTO - CAMIONETA

V A R I O S

**814-CH**  
**CHEVROLET**  
Chevy



**814-NP**  
**NISSAN**  
Pick Up



**814-PL**  
**NISSAN**  
Platina



**814-T**  
**FORD**  
Topaz



**814-T2**  
**NISSAN**  
Tsuru II



**814-T3**  
**NISSAN**  
Tsuru III



**814-T2**  
**NISSAN**  
Urban



# CALIDAD Y GARANTÍA DE EXPORTACIÓN





# DIRECTORIO CLIENTES

---

CLIENTE	TELÉFONO	RUTA
---------	----------	------

DIRECCIÓN	ESTADO
-----------	--------

CLIENTE	TELÉFONO	RUTA
---------	----------	------

DIRECCIÓN	ESTADO
-----------	--------

CLIENTE	TELÉFONO	RUTA
---------	----------	------

DIRECCIÓN	ESTADO
-----------	--------

CLIENTE	TELÉFONO	RUTA
---------	----------	------

DIRECCIÓN	ESTADO
-----------	--------

CLIENTE	TELÉFONO	RUTA
---------	----------	------

DIRECCIÓN	ESTADO
-----------	--------

CLIENTE	TELÉFONO	RUTA
---------	----------	------

DIRECCIÓN	ESTADO
-----------	--------

CLIENTE	TELÉFONO	RUTA
---------	----------	------

DIRECCIÓN	ESTADO
-----------	--------

CLIENTE	TELÉFONO	RUTA
---------	----------	------

DIRECCIÓN	ESTADO
-----------	--------

CLIENTE	TELÉFONO	RUTA
---------	----------	------

DIRECCIÓN	ESTADO
-----------	--------

CLIENTE	TELÉFONO	RUTA
---------	----------	------

DIRECCIÓN	ESTADO
-----------	--------



# **BUFALO AHM**

---

## **CATÁLOGO**



MR

**MACCHETAS**

---



# M A C H E T A S

## INDICE



<b>CHEVROLET</b> .....	<b>5</b>	<b>NISSAN</b> .....	<b>23</b>
ASTRA .....	5	ALMERA .....	23
AMERICANOS .....		APRIO .....	23
AVEO .....		CAMIONETAS AMERICANAS 4 X 4 .....	
BLAZER .....		QUEST .....	
BLAZER JIMMY .....	6	MAXIMA .....	24
CAVALIER / Z-24 .....		MICRA .....	
CAMIONETAS .....		PLATINA .....	
CELEBRITY .....		SENTRA / LUCINO .....	25
CENTURY .....	7	TIIDA .....	
CHEVY / MONZA / C2 .....		TSUBAME .....	
CITATION / X-11 .....	8	TSURU I .....	26
CORSA .....		TSURU II .....	
CUTLASS .....		TSURU III .....	
MATIZ / MATIZ G2 .....	9	X-TERRA / X-TRAIL .....	27
MERIVA .....		URBAN .....	
SAFARI .....			
TORNADO .....		PEUGEOT .....	28
VENTURE .....	10	206 .....	28
ZAFIRA .....			
		RENAULT .....	28
<b>CHRYSLER</b> .....	<b>11</b>	ALIANCE / ENCORE .....	28
ATOS .....	11	CLIO .....	
CAMIONETAS AMERICANAS .....		R-5 .....	29
CIRRUS .....		R-12 .....	
DART K .....		R-18 .....	
LEBARON .....	12	MEGANE I, II .....	
NEON .....			
NEW YORKER .....		SEAT .....	30
PHANTOM / SHADOW .....	13	ALHAMBRA .....	30
SPIRIT .....		CORDOBA .....	
STRATUS .....	14	IBIZA .....	
VERNA .....		LEÓN .....	31
VOLARE .....		TOLEDO .....	
VOYAGER .....			
		TOYOTA .....	32
<b>FORD</b> .....	<b>15</b>	CAMIONETAS PICK UP 4 X 4 .....	32
AEROSTAR .....	15	TACOMA .....	
AMERICANOS .....			
CONTOUR .....		UNIVERSALES .....	32
COUGAR .....	16	UNIVERSALES CAMIONETAS AMERICANAS .....	33
COURIER .....			
ECOSPORT .....		VOLKSWAGEN .....	33
ESCORT .....		BEETLE .....	33
EXPLORER .....	17	BORA .....	
F-150 / F-350 .....		CARIBE / ATLANTIC .....	34
FAIRMONT .....		COMBI / CARAVELLE .....	
FIESTA .....		CORSA .....	
FOCUS .....	18	DERBY .....	
GUIA .....		EUROVAN .....	35
IKON .....		EUROVAN DIESEL .....	
KA .....		GOLF A2 / JETTA A2 .....	
MONDEO .....	19	GOLF A3 / JETTA A3 .....	
MYSTIQUE .....		GOLF A4 / JETTA A4 .....	36
MUSTANG .....		GOLF VR6 / JETTA VR6 .....	
RANGER .....	20	POINTER .....	
TAURUS .....		SHARAN .....	37
TOPAZ .....		VW SEDÁN .....	
WINDSTAR .....	21		
<b>HONDA</b> .....	<b>22</b>		
ACCORD .....	22		
CIVIC .....			
CR-V .....			



MR

# CALIDAD Y GARANTÍA DE EXPORTACIÓN

**NOTA: TODAS LAS FOTOGRAFÍAS USADAS TIENEN UN FIN  
ILUSTRATIVO Y NO CORRESPONDEN AL TAMAÑO ORIGINAL.  
( PARA MAYORES INFORMES ACERCA DE CUALQUIER PRODUCTO,  
CONSULTE A SU DISTRIBUIDOR AUTORIZADO)**

ASTRA		C M				
MODELO	POSICIÓN	ESPECIFICACIÓN	Ø SUPERIOR	Ø INFERIOR	ALTURA	No. <i>BUFALO</i>
00 - 08	RUEDA	DER / IZQ	2.0	7.0	10.2	<b>MC-G-726</b>
	CAJA	DER / IZQ	2.6	6.6	9.5	<b>MC-G-727</b>



**MC-G-726**

**MC-G-727**

AMERICANOS		C M				
MODELO	POSICIÓN	ESPECIFICACIÓN	Ø SUPERIOR	Ø INFERIOR	ALTURA	No. <i>BUFALO</i>
	RUEDA	DER / IZQ / TRIPOIDE	2.7	8.7	8.9	<b>MC-G-714</b>
	CAJA	DER / IZQ / TRIPOIDE / <i>CHICO</i>	2.0	7.5	10.2	<b>MC-G-713</b>
	CAJA	DER / IZQ / TRIPOIDE / <i>MEDIANO</i>	2.5	8.5	10.8	<b>MC-G-712</b>
	CAJA	DER / IZQ / TRIPOIDE / <i>GRANDE</i>	2.4	9.3	10.1	<b>MC-G-711</b>
	CAJA	DER / IZQ / TRIPOIDE / <i>EXTRAGRANDE</i>	2.3	9.1	10.3	<b>MC-G-719</b>



**MC-G-711**

**MC-G-712**

**MC-G-713**

**MC-G-714**

**MC-G-719**

AVEO		C M				
MODELO	POSICIÓN	ESPECIFICACIÓN	Ø SUPERIOR	Ø INFERIOR	ALTURA	No. <i>BUFALO</i>
04 - 11	DIRECCIÓN	DER / IZQ	2.5	9	12.8	<b>MC-G-738</b>

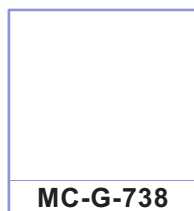

**MC-G-738**

BLAZER		C M				
MODELO	POSICIÓN	ESPECIFICACIÓN	Ø SUPERIOR	Ø INFERIOR	ALTURA	No. <i>BUFALO</i>
97 - 00	RUEDA	DER / IZQ	2.5	9	12.8	<b>MC-G-717</b>



**MC-G-717**



# CHEVROLET

**AUTOS Y CAMIONETAS**

BLAZER JIMMY			C M			No. BUFALO
MODELO	POSICIÓN	ESPECIFICACIÓN	Ø SUPERIOR	Ø INFERIOR	ALTURA	
	RUEDA	DER / IZQ	2.8	10.0	13.0	<b>MC-G-736</b>
	CAJA	DER / IZQ	2.8	9.3	13.0	<b>MC-G-737</b>



CAVALIER / Z-24			C M			No. BUFALO
MODELO	POSICIÓN	ESPECIFICACIÓN	Ø SUPERIOR	Ø INFERIOR	ALTURA	
90 - 05	RUEDA	DER / IZQ	2.3	8.0	10.0	<b>MC-G-705</b>
90 - 96	CAJA	DER / IZQ	2.3	8.3	10.6	<b>MC-G-704</b>
97 - 05	CAJA	DER / IZQ / TRIPOIDE	2.4	9.3	10.1	<b>MC-G-711</b>
90 - 05	DIRECCIÓN	CENTRAL	5.5	6.5	4.5	<b>MC-G-734</b>



CAMIONETAS			C M			No. BUFALO
MODELO	POSICIÓN	ESPECIFICACIÓN	Ø SUPERIOR	Ø INFERIOR	ALTURA	
00 - 10	RUEDA	DER / IZQ	2.5	9.0	12.8	<b>MC-G-717</b>
	DIR. HIDRA.	DER / IZQ	1.3	5.0	20.2	<b>MC-G-728</b>



CELEBRITY			C M			No. BUFALO
MODELO	POSICIÓN	ESPECIFICACIÓN	Ø SUPERIOR	Ø INFERIOR	ALTURA	
83 - 90	RUEDA	DER / IZQ	2.2	8.0	7.0	<b>MC-G-710</b>
	CAJA	DER / IZQ	2.5	6.7	11.6	<b>MC-G-709</b>
82	CAJA	DER / IZQ	2.3	8.3	10.4	<b>MC-G-700</b>
82 - 90	CAJA	DER / IZQ	2.3	8.9	10.0	<b>MC-G-701</b>
	CAJA	DER / IZQ / TRIPOIDE	2.4	9.3	10.1	<b>MC-G-711</b>
	DIR. HIDRA.	DER / IZQ	1.6	4.7	18.5	<b>MC-G-706</b>
	DIR. STD.	DER / IZQ	1.1	4.7	18.5	<b>MC-G-708</b>

CONTINÚA...

## CELEBRITY

						
<b>MC-G-700</b>	<b>MC-G-701</b>	<b>MC-G-706</b>	<b>MC-G-708</b>	<b>MC-G-709</b>	<b>MC-G-710</b>	<b>MC-G-711</b>

## CENTURY

		C M				
MODELO	POSICIÓN	ESPECIFICACIÓN	Ø SUPERIOR	Ø INFERIOR	ALTURA	No. <i>BUFALO</i>
83 - 90	RUEDA	DER / IZQ	2.2	8.0	7.0	<b>MC-G-710</b>
	CAJA	DER / IZQ	2.5	6.7	11.6	<b>MC-G-709</b>
	CAJA	DER / IZQ	2.3	8.9	10.0	<b>MC-G-701</b>
91 - 95	RUEDA	DER / IZQ	2.3	8.0	10.0	<b>MC-G-705</b>
	CAJA	DER / IZQ	2.3	8.3	10.6	<b>MC-G-704</b>

				
<b>MC-G-701</b>	<b>MC-G-704</b>	<b>MC-G-705</b>	<b>MC-G-709</b>	<b>MC-G-710</b>

## CHEVY MONZA C2 MONZA, CHEVY C2

		C M				
MODELO	POSICIÓN	ESPECIFICACIÓN	Ø SUPERIOR	Ø INFERIOR	ALTURA	No. <i>BUFALO</i>
94 - 00	RUEDA	DER / IZQ	2.4	7.9	10.4	<b>MC-G-715</b>
94 - 99	CAJA	DER / IZQ	1.9	7.6	10.4	<b>MC-G-718</b>
97 - 00	CAJA	DER / IZQ	2.2	7.0	12.0	<b>MC-G-731</b>
00 - 10	CAJA STD.	DER / IZQ / TRIPOIDE	2.0	7.5	10.2	<b>MC-G-720</b>
	CAJA AUT.	DER / IZQ / TRIPOIDE	1.9	7.6	10.4	<b>MC-G-735</b>
94 - 10	DIR. STD.	DER / IZQ	1.2	4.7	15.5	<b>MC-G-716</b>
	DIR. HIDRA.	DER / IZQ	1.3	4.9	17	<b>MC-G-729</b>
10 - 11	DIR. STD.	DER / IZQ	1.5	4.2	16	<b>MC-G-739</b>

						
<b>MC-G-715</b>	<b>MC-G-716</b>	<b>MC-G-718</b>	<b>MC-G-720</b>	<b>MC-G-729</b>	<b>MC-G-731</b>	<b>MC-G-735</b>

<b>MC-G-739</b>



# CHEVROLET

**AUTOS Y CAMIONETAS**

CITATION, X-11			C M			
MODELO	POSICIÓN	ESPECIFICACIÓN	Ø SUPERIOR	Ø INFERIOR	ALTURA	No. BUFALO
83 - 88	RUEDA	DER / IZQ	2.2	8.0	7.0	<b>MC-G-710</b>
	CAJA	DER / IZQ	2.5	6.7	11.6	<b>MC-G-709</b>
82	DIR. HIDRA.	DER / IZQ	2.3	8.3	16.4	<b>MC-G-700</b>
82 - 90	RUEDA	DER / IZQ	2.3	8.9	10.0	<b>MC-G-701</b>
	CAJA	DER / IZQ	1.6	4.7	18.5	<b>MC-G-706</b>
	CAJA	DER / IZQ	1.1	4.7	18.2	<b>MC-G-708</b>



CORSA			C M			
MODELO	POSICIÓN	ESPECIFICACIÓN	Ø SUPERIOR	Ø INFERIOR	ALTURA	No. BUFALO
02 - 08	RUEDA	DER / IZQ	2.2	7.8	11.7	<b>MC-G-724</b>
	CAJA	DER / IZQ	2.2	7.6	9.8	<b>MC-G-725</b>
	DIR. HIDRA.	DER / IZQ	1.3	4.9	17	<b>MC-G-729</b>



CUTLASS			C M			
MODELO	POSICIÓN	ESPECIFICACIÓN	Ø SUPERIOR	Ø INFERIOR	ALTURA	No. BUFALO
87 - 90	RUEDA	DER / IZQ	2.6	8.9	13.9	<b>MC-G-702</b>
	CAJA	DER / IZQ	2.3	8.9	10.0	<b>MC-G-701</b>
	CAJA	DER / IZQ	2.1	9.6	14.0	<b>MC-G-703</b>
91 - 95	RUEDA	DER / IZQ	2.3	8.0	10.0	<b>MC-G-705</b>
	CAJA	DER / IZQ	2.3	8.3	10.6	<b>MC-G-704</b>
87 - 95	DIR. HIDRA.	DER / IZQ	1.2	5.9	15.8	<b>MC-G-707</b>





MATIZ, MATIZ G2			C M			
MODELO	POSICIÓN	ESPECIFICACIÓN	Ø SUPERIOR	Ø INFERIOR	ALTURA	No. <i>BUFALO</i>
04 - 10	RUEDA	DER / IZQ	2.1	6.7	8.5	<b>MC-G-722</b>
	CAJA	DER / IZQ / TRIPOIDE	2.1	6.6	8.2	<b>MC-G-723</b>
	DIRECCIÓN	DER / IZQ	0.9	4.2	17.5	<b>MC-G-730</b>



MERIVA			C M			
MODELO	POSICIÓN	ESPECIFICACIÓN	Ø SUPERIOR	Ø INFERIOR	ALTURA	No. <i>BUFALO</i>
02 - 08	RUEDA	DER / IZQ	2.2	7.8	11.7	<b>MC-G-724</b>
	CAJA	DER / IZQ	2.6	6.6	9.5	<b>MC-G-727</b>



SAFARI			C M			
MODELO	POSICIÓN	ESPECIFICACIÓN	Ø SUPERIOR	Ø INFERIOR	ALTURA	No. <i>BUFALO</i>
	RUEDA	DER / IZQ	2.8	10.0	13.0	<b>MC-G-736</b>
	CAJA	DER / IZQ	2.8	9.3	13.0	<b>MC-G-737</b>



TORNADO			C M			
MODELO	POSICIÓN	ESPECIFICACIÓN	Ø SUPERIOR	Ø INFERIOR	ALTURA	No. <i>BUFALO</i>
04 - 11	RUEDA	DER / IZQ	2.5	13.0	13.0	<b>MC-G-732</b>
	CAJA	DER / IZQ	1.8	6.5	10.0	<b>MC-G-733</b>
	DIR. HIDRA.	DER / IZQ	1.3	4.9	17.0	<b>MC-G-729</b>





# CHEVROLET

**AUTOS Y CAMIONETAS**

VENTURE			C M			No. BUFALO
MODELO	POSICIÓN	ESPECIFICACIÓN	Ø SUPERIOR	Ø INFERIOR	ALTURA	
99 - 05	RUEDA	DER / IZQ	2.1	9.6	14.0	<b>MC-G-721</b>



ZAFIRA			C M			No. BUFALO
MODELO	POSICIÓN	ESPECIFICACIÓN	Ø SUPERIOR	Ø INFERIOR	ALTURA	
02 - 06	RUEDA	DER / IZQ	2.2	7.8	11.7	<b>MC-G-724</b>
	CAJA	DER / IZQ	2.6	6.6	9.5	<b>MC-G-727</b>



# CALIDAD Y GARANTÍA

ATOS		C M				
MODELO	POSICIÓN	ESPECIFICACIÓN	Ø SUPERIOR	Ø INFERIOR	ALTURA	No. BUFALO
00 - 11	RUEDA	DER / IZQ	2.3	7.1	8.4	<b>MC-C-419</b>
	CAJA	DER / IZQ / TRIPOIDE	2.0	6.3	8.6	<b>MC-C-420</b>
	DIRECCIÓN	DER / IZQ	1.2	4.2	17.5	<b>MC-C-421</b>



**MC-C-419**

**MC-C-420**

**MC-C-421**

CAMIONETAS AMERICANAS		C M				
MODELO	POSICIÓN	ESPECIFICACIÓN	Ø SUPERIOR	Ø INFERIOR	ALTURA	No. BUFALO
	CAJA	DER / IZQ / BOCA CHICA	4.2	7.3	10.6	<b>MC-C-416</b>
	CAJA	DER / IZQ / BOCA GRANDE	3.8	8.5	8.9	<b>MC-C-417</b>



**MC-C-416**

**MC-C-417**

CIRRUS		C M				
MODELO	POSICIÓN	ESPECIFICACIÓN	Ø SUPERIOR	Ø INFERIOR	ALTURA	No. BUFALO
	RUEDA	DER / IZQ	2.5	7.7	11.4	<b>MC-C-414</b>
	CAJA	DER / IZQ / TRIPOIDE	2.5	8.5	10.8	<b>MC-C-412</b>
95 - 06	CAJA	IZQ	2.4	7.8	10.1	<b>MC-C-413</b>
	DIR. HIDRA.	DER / IZQ	1.5	4.6	19.0	<b>MC-C-415</b>



**MC-C-412**

**MC-C-413**

**MC-C-414**

**MC-C-415**

DART K		C M				
MODELO	POSICIÓN	ESPECIFICACIÓN	Ø SUPERIOR	Ø INFERIOR	ALTURA	No. BUFALO
82 - 89	RUEDA	DER / IZQ	2.4	8.3	8.7	<b>MC-C-401</b>
	CAJA	DER	3.2	4.8	9.5	<b>MC-C-400</b>
	CAJA	IZQ	1.9	7.6	10.4	<b>MC-C-407</b>
	DIR. HIDRA.	DER / IZQ	1.2	4.5	20.8	<b>MC-C-402</b>
	DIR. STD.	DER / IZQ	1.1	4.7	15.5	<b>MC-C-404</b>



# CHEVROLET

AUTOS Y CAMIONETAS

## DART K



## LEBARON

C M

MODELO	POSICIÓN	ESPECIFICACIÓN	Ø SUPERIOR	Ø INFERIOR	ALTURA	No. BUFALO
82 - 89	RUEDA	DER / IZQ	8.7	8.3	8.7	MC-C-401
	CAJA	DER	9.5	4.8	9.5	MC-C-400
	CAJA	IZQ	10.4	7.6	10.4	MC-C-407
	DIR. HIDRA.	DER / IZQ	20.8	4.5	20.8	MC-C-402
	DIR. STD..	DER / IZQ	12.5	5.0	15.5	MC-C-403



## NEON

C M

MODELO	POSICIÓN	ESPECIFICACIÓN	Ø SUPERIOR	Ø INFERIOR	ALTURA	No. BUFALO
	RUEDA	DER / IZQ	2.2	7.7	11.1	MC-C-411
	CAJA	DER / TRIPOIDE	2.0	7.5	10.0	MC-C-409
	CAJA	IZQ	2.4	7.6	9.8	MC-C-410
00 - 07	RUEDA	DER / IZQ	2.4	8.2	9.3	MC-C-430
	CAJA	DER / IZQ / TRIPOIDE	2.1	7.2	10.5	MC-C-427



## NEW YORKER

C M

MODELO	POSICIÓN	ESPECIFICACIÓN	Ø SUPERIOR	Ø INFERIOR	ALTURA	No. BUFALO
	RUEDA	DER / IZQ	2.2	8.0	7.0	MC-C-414
	RUEDA	DER / IZQ	2.5	7.0	8.8	MC-C-412
90 - 95	CAJA	DER / IZQ	2.3	8.3	10.6	MC-C-413
	DIR. HIDRA.	DER / IZQ	1.4	4.5	16.8	MC-C-415

CONTINÚA...

# CHRYSLER

AUTOS Y CAMIONETAS



MR

## NEW YORKER



MC-C-405

MC-C-408

MC-C-418

MC-C-422

## PHANTOM, SHADOW

C M

MODELO	POSICIÓN	ESPECIFICACIÓN	Ø SUPERIOR	Ø INFERIOR	ALTURA	No. BUFALO
88 - 89	RUEDA	DER / IZQ	2.4	8.3	8.7	MC-C-401
	CAJA	DER	3.2	4.8	9.5	MC-C-400
	CAJA	IZQ	1.9	7.6	10.4	MC-C-407
	DIR. HIDRA.	DER / IZQ	1.2	4.5	20.8	MC-C-402
	DIR. STD.	DER / IZQ	1.1	5.0	12.5	MC-C-403
	RUEDA	DER / IZQ	2.2	8.0	7.0	MC-C-406
	RUEDA	DER / IZQ	2.5	7.8	8.8	MC-C-418
90 - 95	CAJA	DER / IZQ	2.3	8.3	10.6	MC-C-408
	DIR. HIDRA.	DER / IZQ	1.4	4.5	16.8	MC-C-405

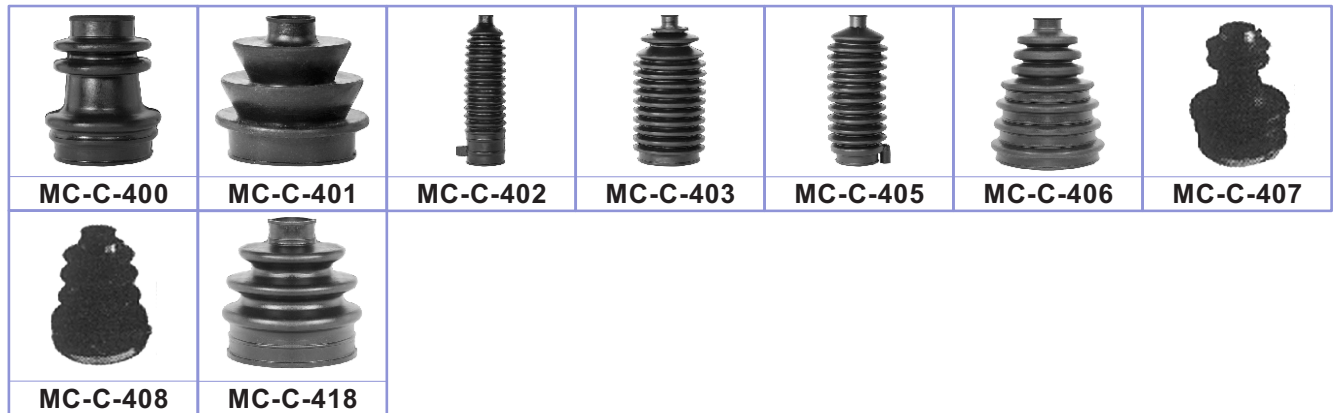

MC-C-400

MC-C-401

MC-C-402

MC-C-403

MC-C-405

MC-C-406

MC-C-407

MC-C-408

MC-C-418

## SPIRIT

C M

MODELO	POSICIÓN	ESPECIFICACIÓN	Ø SUPERIOR	Ø INFERIOR	ALTURA	No. BUFALO
88 - 89	RUEDA	DER / IZQ	2.2	8.0	7.0	MC-C-406
	RUEDA	DER / IZQ	2.5	7.8	8.8	MC-C-418
	CAJA	DER	3.2	4.8	9.5	MC-C-400
90	CAJA	IZQ	1.9	7.6	10.4	MC-C-407
	DIR. HIDRA.	DER / IZQ	1.2	4.5	20.8	MC-C-402
91 - 95	CAJA	DER / IZQ	2.3	8.3	10.6	MC-C-408
	DIR. HIDRA.	DER / IZQ	1.4	4.5	16	MC-C-405



MC-C-400

MC-C-402

MC-C-405

MC-C-406

MC-C-407

MC-C-408

MC-C-418



# CHRYSLER

**AUTOS Y CAMIONETAS**

STRATUS			C M			
MODELO	POSICIÓN	ESPECIFICACIÓN	Ø SUPERIOR	Ø INFERIOR	ALTURA	No. BUFALO
95 - 06	RUEDA	DER / IZQ	2.5	7.7	11.4	MC-C-414
	CAJA	DER / TRIPOIDE	2.5	8.5	10.8	MC-C-412
	CAJA	IZQ	2.4	7.8	10.1	MC-C-413
	DIR. HIDRA.	DER / IZQ	1.5	4.6	19.0	MC-C-415



VERNA			C M			
MODELO	POSICIÓN	ESPECIFICACIÓN	Ø SUPERIOR	Ø INFERIOR	ALTURA	No. BUFALO
04 - 06	RUEDA	DER / IZQ	2.2	7.3	8.5	MC-C-423
	CAJA STD.	DER / IZQ	2.1	6.0	8.2	MC-C-424
	CAJA AUT.	DER / IZQ	2.2	6.8	8.2	MC-C-425
	DIRECCIÓN	DER / IZQ	1.5	4.5	18.5	MC-C-426



VOLARE			C M			
MODELO	POSICIÓN	ESPECIFICACIÓN	Ø SUPERIOR	Ø INFERIOR	ALTURA	No. BUFALO
82 - 89	RUEDA	DER / IZQ	8.3	2.4	8.3	MC-C-401
	CAJA	DER	4.8	3.2	9.5	MC-C-400
	CAJA	IZQ	7.6	1.9	10.4	MC-C-407
	DIR. HIDRA.	DER / IZQ	4.5	1.2	20.8	MC-C-402
	DIR. STD.	DER / IZQ	4.7	1.1	15.5	MC-C-404



VOYAGER			C M			
MODELO	POSICIÓN	ESPECIFICACIÓN	Ø SUPERIOR	Ø INFERIOR	ALTURA	No. BUFALO
95 - 00	RUEDA	DER / IZQ	2.6	9.17	12.7	MC-C-428
	CAJA	DER / TRIPOIDE	2.5	8.5	10.8	MC-C-412
	CAJA	IZQ / TRIPOIDE	2.5	7.8	10.6	MC-C-429

CONTINÚA...

# CHRYSLER

AUTOS Y CAMIONETAS



## VOYAGER



MC-C-412

MC-C-428

MC-C-429

# FORD

AUTOS Y CAMIONETAS

## AEROSTAR

		C M				
MODELO	POSICIÓN	ESPECIFICACIÓN	Ø SUPERIOR	Ø INFERIOR	ALTURA	No. BUFALO
86 - 97	DIR. HIDRA.	DER / IZQ	1.0	5.8	18.8	MC-F-611



MC-F-611

## AMERICANOS

		C M				
MODELO	POSICIÓN	ESPECIFICACIÓN	Ø SUPERIOR	Ø INFERIOR	ALTURA	No. BUFALO
	CAJA	DER / IZQ / TRIPOIDE	2.3	7.8	8.5	MC-F-624



MC-F-624

## CONTOUR

		C M				
MODELO	POSICIÓN	ESPECIFICACIÓN	Ø SUPERIOR	Ø INFERIOR	ALTURA	No. BUFALO
85 - 00	RUEDA	DER / IZQ	2.3	8.3	9.5	MC-F-620



MC-F-620



# F O R D

**AUTOS Y CAMIONETAS**

COUGAR			C M			No. BUFALO
MODELO	POSICIÓN	ESPECIFICACIÓN	Ø SUPERIOR	Ø INFERIOR	ALTURA	
89 - 92	RUEDA	DER / IZQ	2.3	8.0	10.0	MC-F-614
	CAJA	DER / IZQ	2.3	8.3	10.6	MC-F-612
84 - 86	DIR. HIDRA.	DER / IZQ	1.1	5.3	14.8	MC-F-600
89 - 92	DIR. HIDRA.	DER / IZQ	1.2	5.5	20.2	MC-F-605



COURIER			C M			No. BUFALO
MODELO	POSICIÓN	ESPECIFICACIÓN	Ø SUPERIOR	Ø INFERIOR	ALTURA	
99 - 05	RUEDA	DER / IZQ	2.4	8.0	8.5	MC-F-622
	CAJA	DER / IZQ / TRIPOIDE	1.9	6.9	7.8	MC-F-621



ECOSPORT			C M			No. BUFALO
MODELO	POSICIÓN	ESPECIFICACIÓN	Ø SUPERIOR	Ø INFERIOR	ALTURA	
02 - 11	RUEDA	DER / IZQ	2.4	8.0	8.5	MC-F-622
	CAJA	DER / IZQ	2.0	7.5	7.8	MC-F-626
	DIRECCIÓN	DER / IZQ	1.3	5.3	19.1	MC-F-625



ESCORT			C M			No. BUFALO
MODELO	POSICIÓN	ESPECIFICACIÓN	Ø SUPERIOR	Ø INFERIOR	ALTURA	
97 - 02	CAJA	DER / IZQ	2.2	7.3	9.5	MC-F-616
	RUEDA	DER / IZQ	1.9	6.8	8.5	MC-F-617





EXPLORER		C M				No. BUFALO
MODELO	POSICIÓN	ESPECIFICACIÓN	Ø SUPERIOR	Ø INFERIOR	ALTURA	
96 - 07	DIR. HIDRA.	DER / IZQ	1.3	6.8	19.3	<b>MC-F-628</b>



**MC-F-628**

F-150, F-350		C M				No. BUFALO
MODELO	POSICIÓN	ESPECIFICACIÓN	Ø SUPERIOR	Ø INFERIOR	ALTURA	
04 - 11	DIR. HIDRA.	DER / IZQ	1.6	5.5	22.9	<b>MC-F-627</b>
	DIR. HIDRA.	DER / IZQ / 4 X 4	8.0	6.5	21.0	<b>MC-F-629</b>



**MC-F-627**

**MC-F-629**

FAIRMONT		C M				No. BUFALO
MODELO	POSICIÓN	ESPECIFICACIÓN	Ø SUPERIOR	Ø INFERIOR	ALTURA	
74 - 77	DIR. HIDRA.	DER / IZQ	1.1	4.6	12.4	<b>MC-F-602</b>
78 - 83	DIR. HIDRA.	DER / IZQ	1.1	5.3	14.8	<b>MC-F-600</b>
	DIR. STD	DER / IZQ	1.0	4.5	15.4	<b>MC-F-608</b>



**MC-F-600**

**MC-F-602**

**MC-F-608**

FIESTA		C M				No. BUFALO
MODELO	POSICIÓN	ESPECIFICACIÓN	Ø SUPERIOR	Ø INFERIOR	ALTURA	
98 - 01	CAJA	DER / IZQ / TRIPOIDE	2.5	7.5	12.0	<b>MC-F-618</b>
01 - 06	RUEDA	DER / IZQ	2.4	8	8.5	<b>MC-F-622</b>
	CAJA	DER / IZQ / TRIPOIDE	1.9	6.9	7.8	<b>MC-F-621</b>



**MC-F-618**

**MC-F-621**

**MC-F-622**



# F O R D

**AUTOS Y CAMIONETAS**

FOCUS			C M			No. BUFALO
MODELO	POSICIÓN	ESPECIFICACIÓN	Ø SUPERIOR	Ø INFERIOR	ALTURA	
00 - 05	RUEDA	DER / IZQ	2.4	8.0	8.5	<b>MC-F-622</b>
	CAJA	DER / IZQ / TRIPOIDE	2.5	8.2	10.4	<b>MC-F-623</b>
	DIRECCIÓN	DER / IZQ	1.3	5.3	19.1	<b>MC-F-624</b>
	RUEDA	DER / IZQ	2.5	7.5	10.5	<b>MC-F-631</b>



GUIA			C M			No. BUFALO
MODELO	POSICIÓN	ESPECIFICACIÓN	Ø SUPERIOR	Ø INFERIOR	ALTURA	
91	RUEDA	DER / IZQ	2.2	8.5	7.0	<b>MC-F-610</b>
	CAJA	DER / IZQ	2.5	6.7	12.2	<b>MC-F-609</b>
92 - 94	RUEDA	DER / IZQ	2.3	8.0	10.0	<b>MC-F-614</b>
	CAJA	DER / IZQ	2.3	8.3	10.2	<b>MC-F-612</b>
91 - 94	DIR. HIDRA.	DER / IZQ	1.0	5.8	18.8	<b>MC-F-611</b>



IKON			C M			No. BUFALO
MODELO	POSICIÓN	ESPECIFICACIÓN	Ø SUPERIOR	Ø INFERIOR	ALTURA	
01 - 06	RUEDA	DER / IZQ	2.4	8.0	8.5	<b>MC-F-622</b>
	CAJA	DER / IZQ / TRIPOIDE	1.9	6.9	7.8	<b>MC-F-621</b>



KA			C M			No. BUFALO
MODELO	POSICIÓN	ESPECIFICACIÓN	Ø SUPERIOR	Ø INFERIOR	ALTURA	
01 - 06	RUEDA	DER / IZQ	2.4	8.0	8.5	<b>MC-F-622</b>
	CAJA	DER / IZQ / TRIPOIDE	1.9	6.9	7.8	<b>MC-F-621</b>

CONTINÚA...

# F O R D

**AUTOS Y CAMIONETAS**



**KA**



**MC-F-621**



**MC-F-622**

**MONDEO**

C M

MODELO	POSICIÓN	ESPECIFICACIÓN	Ø SUPERIOR	Ø INFERIOR	ALTURA	No. <i>BUFALO</i>
99 - 05	RUEDA	DER / IZQ	2.4	8.0	8.5	<b>MC-F-622</b>
	CAJA	DER / IZQ / TRIPOIDE	2.5	8.2	10.4	<b>MC-F-623</b>
	DIRECCIÓN	DER / IZQ	1.3	5.3	19.1	<b>MC-F-625</b>



**MC-F-622**



**MC-F-623**



**MC-F-625**

**MYSTIQUE**

C M

MODELO	POSICIÓN	ESPECIFICACIÓN	Ø SUPERIOR	Ø INFERIOR	ALTURA	No. <i>BUFALO</i>
95 - 00	RUEDA	DER / IZQ	2.3	8.3	9.5	<b>MC-F-620</b>



**MC-F-620**

**MUSTANG**

C M

MODELO	POSICIÓN	ESPECIFICACIÓN	Ø SUPERIOR	Ø INFERIOR	ALTURA	No. <i>BUFALO</i>
74 - 77	DIRECCIÓN	DER / IZQ	1.1	4.6	12.4	<b>MC-F-602</b>
78 - 83	DIR. HIDRA.	DER / IZQ	1.2	4.6	19.5	<b>MC-F-601</b>



**MC-F-601**



**MC-F-602**



# F O R D

**AUTOS Y CAMIONETAS**

RANGER		C M				No. BUFALO
MODELO	POSICIÓN	ESPECIFICACIÓN	Ø SUPERIOR	Ø INFERIOR	ALTURA	
96 - 07	DIR. HIDRA.	DER / IZQ	1.3	6.8	19.3	<b>MC-F-628</b>



TAURUS		C M				No. BUFALO
MODELO	POSICIÓN	ESPECIFICACIÓN	Ø SUPERIOR	Ø INFERIOR	ALTURA	
88 - 91	RUEDA	DER / IZQ	2.3	8.0	10.0	<b>MC-F-614</b>
	CAJA	DER / IZQ	2.3	8.3	10.6	<b>MC-F-612</b>
	DIR. HIDRA.	DER / IZQ	1.2	5.5	20.2	<b>MC-F-605</b>



TOPAZ		C M				No. BUFALO
MODELO	POSICIÓN	ESPECIFICACIÓN	Ø SUPERIOR	Ø INFERIOR	ALTURA	
84 - 90	RUEDA	DER / IZQ	2.2	8.5	7.0	<b>MC-F-610</b>
	CAJA	DER / IZQ	2.5	6.7	12.2	<b>MC-F-609</b>
	DIR. STD.	DER / IZQ	1.2	3.0	17.2	<b>MC-F-603</b>
	DIR. STD.	DER / IZQ	1.1	4.5	14.9	<b>MC-F-607</b>
	DIR. HIDRA.	DER / IZQ	1.0	4.4	21.2	<b>MC-F-604</b>
91 - 94	RUEDA	DER / IZQ	2.2	7.2	7.9	<b>MC-F-613</b>
	CAJA	DER / IZQ	2.6	8.9	11.9	<b>MC-F-615</b>
	DIR. HIDRA.	DER / IZQ	1.0	5.8	18.8	<b>MC-F-611</b>



# F O R D

**AUTOS Y CAMIONETAS**



WINDSTAR		C M				No. <i>BUFALO</i>
MODELO	POSICIÓN	ESPECIFICACIÓN	Ø SUPERIOR	Ø INFERIOR	ALTURA	
95 - 00	RUEDA	DER / IZQ	2.15	8.7	2.16	<b>MC-F-630</b>
	CAJA	DER / IZQ	2.3	6.7	10.6	<b>MC-F-612</b>
95 - 03	DIR. HIDRA.	DER / IZQ	1.0	5.8	18.8	<b>MC-F-611</b>
04 - 08	DIR. HIDRA.	DER / IZQ	1.3	6.8	19.3	<b>MC-F-628</b>

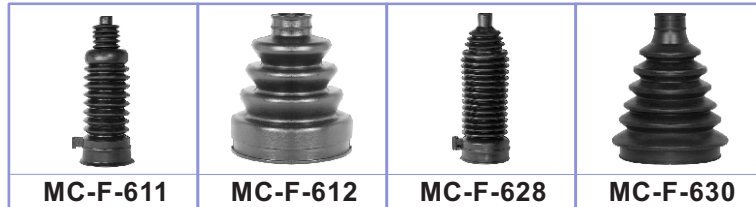

# CALIDAD Y GARANTÍA DE EXPORTACIÓN



# H O N D A

**AUTOS Y CAMIONETAS**

ACCORD			C M			
MODELO	POSICIÓN	ESPECIFICACIÓN	Ø SUPERIOR	Ø INFERIOR	ALTURA	No. BUFALO
97 - 02	RUEDA	DER / IZQ	2.4	7.9	10.4	<b>MC-H-801</b>
	CAJA	DER / IZQ / TRIPOIDE	2.4	7.8	8.8	<b>MC-H-800</b>
03 - 06	RUEDA	DER / IZQ	2.4	8.6	11.6	<b>MC-H-805</b>
	CAJA	DER / IZQ / TRIPOIDE	2.1	7.4	8.2	<b>MC-H-803</b>
97 - 06	DIR. HIDRA.	DER / IZQ	1.0	4.0	16.5	<b>MC-H-802</b>
	DIRECCIÓN	DER / IZA / CORTA	0.9	4.0	14.0	<b>MC-H-804</b>



CIVIC			C M			
MODELO	POSICIÓN	ESPECIFICACIÓN	Ø SUPERIOR	Ø INFERIOR	ALTURA	No. BUFALO
97 - 02	RUEDA	DER / IZQ	2.4	7.9	10.4	<b>MC-H-801</b>
	CAJA	DER / IZQ / TRIPOIDE	2.4	7.8	8.8	<b>MC-H-800</b>
97 - 06	CAJA	DER / IZQ / TRIPOIDE	2.1	7.4	8.2	<b>MC-H-803</b>
	DIR. HIDRA.	DER / IZQ	1.0	4.0	16.5	<b>MC-H-802</b>
	DIRECCIÓN	DER / IZQ / CORTA	0.9	4.0	14.0	<b>MC-H-804</b>



CR - V			C M			
MODELO	POSICIÓN	ESPECIFICACIÓN	Ø SUPERIOR	Ø INFERIOR	ALTURA	No. BUFALO
03 - 06	RUEDA	DER / IZQ	2.3	8.3	9.5	<b>MC-H-807</b>
	CAJA	DER / IZQ / TRIPOIDE	2.1	8.5	8.2	<b>MC-H-808</b>



ALMERA		C M				No. BUFALO
MODELO	POSICIÓN	ESPECIFICACIÓN	Ø SUPERIOR	Ø INFERIOR	ALTURA	
02 - 05	CAJA	DER / IZQ	2.1	7.8	8.6	<b>MC-N-223</b>

**MC-N-223**

APRIO		C M				No. BUFALO
MODELO	POSICIÓN	ESPECIFICACIÓN	Ø SUPERIOR	Ø INFERIOR	ALTURA	
07 - 10	CAJA	DER / IZQ	4.1	7.6	7.2	<b>MC-N-229</b>
	DIRECCIÓN	DER / IZQ	0.9	4.1	14.5	<b>MC-N-232</b>

**MC-N-229**

**MC-N-232**

CAMIONETAS AMERICANAS 4 X 4		C M				No. BUFALO
MODELO	POSICIÓN	ESPECIFICACIÓN	Ø SUPERIOR	Ø INFERIOR	ALTURA	
	RUEDA	DER / IZQ	2.3	8.0	8.0	<b>MC-N-228</b>
	CAJA	DER / IZQ	2.5	8.4	9.4	<b>MC-N-224</b>

**MC-N-224**

**MC-N-228**

QUEST		C M				No. BUFALO
MODELO	POSICIÓN	ESPECIFICACIÓN	Ø SUPERIOR	Ø INFERIOR	ALTURA	
93 - 04	RUEDA	DER / IZQ	2.3	8.0	8.0	<b>MC-N-228</b>
	DIRECCIÓN	DER / IZQ	1.4	5.2	20	<b>MC-N-233</b>

**MC-N-228**

**MC-N-233**



# N I S S A N

**AUTOS Y CAMIONETAS**

MAXIMA			C M			
MODELO	POSICIÓN	ESPECIFICACIÓN	Ø SUPERIOR	Ø INFERIOR	ALTURA	No. BUFALO
	RUEDA	DER / IZQ	2.5	9.8	8.0	<b>MC-N-218</b>
	DIRECCIÓN	DER / IZQ	1.4	5.0	14.8	<b>MC-N-234</b>



**MC-N-218**

**MC-N-234**

MICRA			C M			
MODELO	POSICIÓN	ESPECIFICACIÓN	Ø SUPERIOR	Ø INFERIOR	ALTURA	No. BUFALO
<b>04 - 07</b>	RUEDA	DER / IZQ	2.5	8.3	10.0	<b>MC-N-225</b>
	CAJA	DER / IZQ	2.3	8.0	8.6	<b>MC-N-226</b>
	DIRECCIÓN	DER / IZQ	1.5	4.5	18.4	<b>MC-N-227</b>



**MC-N-225**

**MC-N-226**

**MC-N-227**

PLATINA			C M			
MODELO	POSICIÓN	ESPECIFICACIÓN	Ø SUPERIOR	Ø INFERIOR	ALTURA	No. BUFALO
<b>02 - 08</b>	RUEDA	DER / IZQ / STD	2.5	8.2	11.5	<b>MC-N-217</b>
	RUEDA	DER / IZQ / AUT	2.5	8.3	10	<b>MC-N-220</b>
	CAJA	DER / IZQ / STD	4.1	8.6	8.8	<b>MC-N-216</b>
	CAJA	DER / IZQ / AUT	7.4	2.5	9.2	<b>MC-N-219</b>
	DIRECCIÓN	DER / IZQ	4.3	1.1	16.3	<b>MC-N-221</b>



**MC-N-216**

**MC-N-217**

**MC-N-219**

**MC-N-220**

**MC-N-221**

# CALIDAD Y GARANTÍA



SENTRA, LUCINO			C M			
MODELO	POSICIÓN	ESPECIFICACIÓN	Ø SUPERIOR	Ø INFERIOR	ALTURA	No. <i>BUFALO</i>
96 - 98	RUEDA	DER / IZQ	2.3	8.5	8.9	<b>MC-N-205</b>
	CAJA	DER / IZQ	1.9	7.6	10.4	<b>MC-N-206</b>
	DIRECCIÓN	DER / IZQ / <i>HIDRÁULICA</i>	1.2	4.5	18.5	<b>MC-N-208</b>
	DIRECCIÓN	DER / STD	1.2	3.6	14.6	<b>MC-N-210</b>
	DIRECCIÓN	IZQ / STD	1.3	3.2	20.0	<b>MC-N-209</b>
98 - 04	RUEDA	DER / IZQ	2.4	7.7	10.4	<b>MC-N-213</b>
	CAJA	DER / IZQ	2.1	7.8	8.6	<b>MC-N-214</b>
	DIRECCIÓN	DER / IZQ	1.5	4.5	18.4	<b>MC-N-227</b>
05 - 09	RUEDA	DER / IZQ	2.4	8.2	9.3	<b>MC-N-231</b>
	CAJA	DER / IZQ / <i>TRIPOIDE</i>	2.5	9.0	8.5	<b>MC-N-236</b>
	DIRECCIÓN	DER / IZQ	1.5	5.0	16.0	<b>MC-N-237</b>



TIIDA			C M			
MODELO	POSICIÓN	ESPECIFICACIÓN	Ø SUPERIOR	Ø INFERIOR	ALTURA	No. <i>BUFALO</i>
06 - 11	RUEDA	DER / IZQ	2.4	8.2	9.3	<b>MC-N-231</b>
	DIRECCIÓN	DER / IZQ	0.9	4.1	14.5	<b>MC-N-232</b>



TSUBAME			C M			
MODELO	POSICIÓN	ESPECIFICACIÓN	Ø SUPERIOR	Ø INFERIOR	ALTURA	No. <i>BUFALO</i>
94 - 04	RUEDA	DER / IZQ	2.3	8.3	8.5	<b>MC-N-212</b>
	CAJA	DER / IZQ	1.6	7.2	10.9	<b>MC-N-211</b>
	CAJA	DER / IZQ / <i>TRIPOIDE</i>	2.4	8.1	8.7	<b>MC-N-215</b>
	DIRECCIÓN	IZQ / STD	1.2	3.6	14.6	<b>MC-N-210</b>
	DIRECCIÓN	DER / STD	1.3	3.2	20.0	<b>MC-N-209</b>
	DIRECCIÓN	DER / IZQ / <i>HIDRÁULICA</i>	1.2	4.5	18.5	<b>MC-N-208</b>



# N I S S A N

**AUTOS Y CAMIONETAS**

## TSUBAME

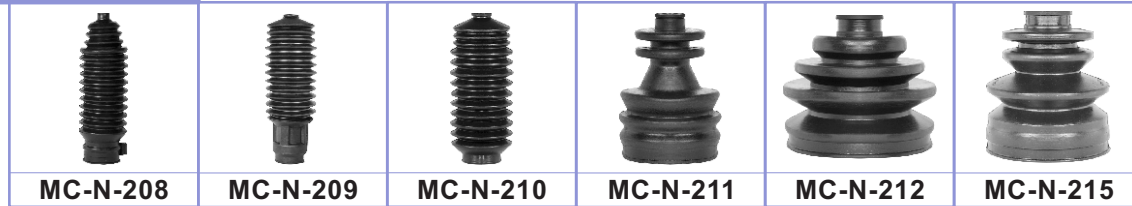

## TSURU I

C M

MODELO	POSICIÓN	ESPECIFICACIÓN	Ø SUPERIOR	Ø INFERIOR	ALTURA	No. BUFALO
84 - 87	RUEDA	DER / IZQ	2.0	7.9	8.0	<b>MC-N-204</b>
	CAJA	DER / IZQ	2.5	6.7	11.6	<b>MC-N-203</b>
	DIRECCIÓN	IZQ / STD	1.2	3.3	14.4	<b>MC-N-200</b>
	DIRECCIÓN	DER / STD	1.2	3.2	19.6	<b>MC-N-201</b>
	DIRECCIÓN	IZQ / HIDRÁULICA	1.2	3.9	13.6	<b>MC-N-207</b>
	DIRECCIÓN	DER / HIDRÁULICA	1.2	4.6	14.4	<b>MC-N-202</b>

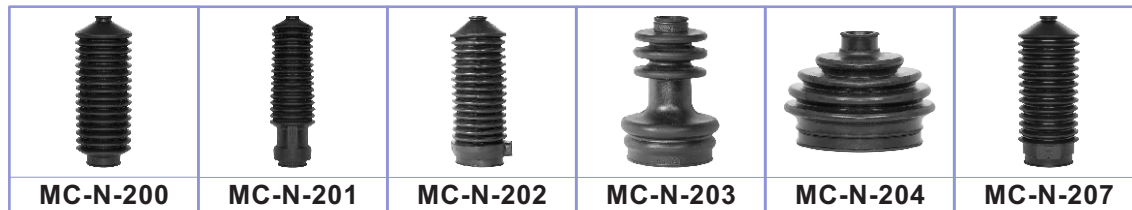

## TSURU II

C M

MODELO	POSICIÓN	ESPECIFICACIÓN	Ø SUPERIOR	Ø INFERIOR	ALTURA	No. BUFALO
88 - 91	RUEDA	DER / IZQ	2.3	8.5	8.9	<b>MC-N-205</b>
	CAJA	DER / IZQ	1.9	7.6	10.4	<b>MC-N-206</b>
	DIRECCIÓN	IZQ / STD	1.2	3.3	14.4	<b>MC-N-200</b>
	DIRECCIÓN	DER / STD	1.2	3.2	19.6	<b>MC-N-201</b>
	DIRECCIÓN	IZQ / HIDRÁULICA	1.2	3.9	13.6	<b>MC-N-207</b>
	DIRECCIÓN	DER / HIDRÁULICA	1.2	4.6	14.4	<b>MC-N-202</b>

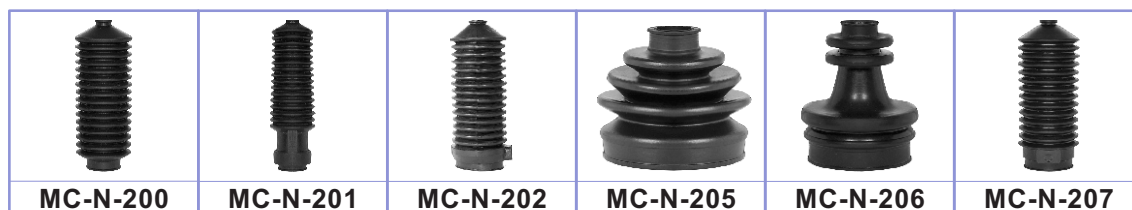

## TSURU III

C M

MODELO	POSICIÓN	ESPECIFICACIÓN	Ø SUPERIOR	Ø INFERIOR	ALTURA	No. BUFALO
92 - 05	RUEDA	DER / IZQ	2.3	8.3	8.5	<b>MC-N-212</b>
	CAJA	DER / IZQ	1.6	7.2	10.9	<b>MC-N-211</b>
GS	CAJA	DER / IZQ / TRIPOIDE	2.4	8.1	8.7	<b>MC-N-215</b>
	DIRECCIÓN	DER / IZQ / STD	1.2	3.6	14.6	<b>MC-N-210</b>
	DIRECCIÓN	DER / IZQ / STD	1.3	3.2	20.0	<b>MC-N-209</b>
	DIRECCIÓN	DER / IZQ	1.2	4.5	18.5	<b>MC-N-208</b>

CONTINÚA...

# N I S S A N

**AUTOS Y CAMIONETAS**



TSURU III		C M					
MODELO	POSICIÓN	ESPECIFICACIÓN	Ø SUPERIOR	Ø INFERIOR	ALTURA	No. <i>BUFALO</i>	
05 - 11	RUEDA	DER / IZQ	2.4	8.2	9.3	<b>MC-N-231</b>	
	CAJA	DER / IZQ / TRIPOIDE	2.5	7.8	10.6	<b>MC-N-230</b>	



X-TERRA, X-TRAIL		C M					
MODELO	POSICIÓN	ESPECIFICACIÓN	Ø SUPERIOR	Ø INFERIOR	ALTURA	No. <i>BUFALO</i>	
00 - 07	RUEDA	DER / IZQ	2.8	9.6	11	<b>MC-N-235</b>	
	CAJA	DER / IZQ / TRIPOIDE	2.5	9.0	8.5	<b>MC-N-236</b>	
	DIRECCIÓN	DER / IZQ	1.5	5.0	16	<b>MC-N-237</b>	



URVAN		C M					
MODELO	POSICIÓN	ESPECIFICACIÓN	Ø SUPERIOR	Ø INFERIOR	ALTURA	No. <i>BUFALO</i>	
00 - 11	DIRECCIÓN	DER / IZQ	2.1	5.0	17.5	<b>MC-N-222</b>	



# CALIDAD Y GARANTÍA



# PEUGEOT

AUTOS Y CAMIONETAS

206		C M					
MODELO	POSICIÓN	ESPECIFICACIÓN	Ø SUPERIOR	Ø INFERIOR	ALTURA	No. BUFALO	
00 - 08	RUEDA	DER / IZQ	3.7	7.5	10.6	MC-P-1000	
	CAJA	DER / IZQ / STD	2.7	7.2	7.9	MC-P-1001	
	CAJA	DER / IZQ / AUT	3.3	7.6	9.3	MC-P-1002	
	DIRECCIÓN	DER / IZQ / HIDRÁULICA	1.6	5.9	18.0	MC-P-1003	



# RENAULT

AUTOS Y CAMIONETAS

ALIANCE, ENCORE		C M					
MODELO	POSICIÓN	ESPECIFICACIÓN	Ø SUPERIOR	Ø INFERIOR	ALTURA	No. BUFALO	
85 - 86	RUEDA	DER / IZQ	2.9	8.2	11.2	MC-R-313	
	CAJA	DER / IZQ	3.4	8.4	10.3	MC-R-312	

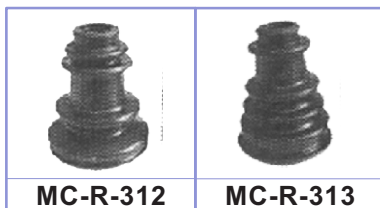

CLIO		C M					
MODELO	POSICIÓN	ESPECIFICACIÓN	Ø SUPERIOR	Ø INFERIOR	ALTURA	No. BUFALO	
02 - 08	RUEDA	DER / IZQ / STD	2.5	8.7	11.5	MC-R-320	
	RUEDA	DER / IZQ / AUT	2.5	8.3	10.0	MC-R-322	
	CAJA	DER / IZQ / STD	4.1	8.6	8.8	MC-R-319	
	CAJA	DER / IZQ / AUT / TRIPOIDE	2.5	7.4	9.2	MC-R-321	
	DIRECCIÓN	DER / IZQ	1.1	4.3	16.3	MC-R-323	



R-5		C M				
MODELO	POSICIÓN	ESPECIFICACIÓN	Ø SUPERIOR	Ø INFERIOR	ALTURA	No. BUFALO
74 - 84	RUEDA	DER / IZQ	2.1	7.4	9.4	<b>MC-R-303</b>
	CAJA	DER / IZQ	1.8	7.1	12.3	<b>MC-R-302</b>
	DIRECCIÓN	DER / IZQ / STD	1.1	3.4	14.6	<b>MC-R-300</b>



R-12		C M				
MODELO	POSICIÓN	ESPECIFICACIÓN	Ø SUPERIOR	Ø INFERIOR	ALTURA	No. BUFALO
74 - 84	RUEDA	DER / IZQ	2.1	7.4	9.4	<b>MC-R-303</b>
	CAJA	DER / IZQ	1.6	8.1	9.8	<b>MC-R-306</b>
	CAJA	DER / IZQ	2.0	7.8	10.8	<b>MC-R-307</b>
	DIRECCIÓN	DER / IZQ / STD	1.1	3.4	14.8	<b>MC-R-300</b>



R-18		C M				
MODELO	POSICIÓN	ESPECIFICACIÓN	Ø SUPERIOR	Ø INFERIOR	ALTURA	No. BUFALO
74 - 84	RUEDA	DER / IZQ / 2 LTS.	2.1	7.4	9.4	<b>MC-R-303</b>
	RUEDA	DER / IZQ / 2 LTS / NACIONAL	2.5	6.7	11.6	<b>MC-R-304</b>
	RUEDA	DER / IZQ / FRANCES ESPECIAL	3.5	8.0	11.0	<b>MC-R-310</b>
	CAJA	DER / IZQ / 2 LTS.	1.8	7.1	12.3	<b>MC-R-302</b>
	CAJA	DER / IZQ / 2 LTS / NACIONAL	2.2	8.0	7.0	<b>MC-R-305</b>
	CAJA	DER / IZQ / FRANCES	3.4	8.4	10.3	<b>MC-R-308</b>
	DIRECCIÓN	DER / IZQ / STD	1.1	3.4	14.6	<b>MC-R-300</b>



MEGANE I, II		C M				
MODELO	POSICIÓN	ESPECIFICACIÓN	Ø SUPERIOR	Ø INFERIOR	ALTURA	No. BUFALO
01 - 09	RUEDA	DER / IZQ	2.5	8.0	10.0	<b>MC-R-324</b>
	RUEDA	DER / IZQ	2.5	7.5	9.5	<b>MC-R-325</b>

CONTINÚA...



# RENAULT

AUTOS Y CAMIONETAS

## MEGANE I, II



MC-R-324

MC-R-325

# SEAT

AUTOS Y CAMIONETAS

## ALHAMBRA

C M

MODELO	POSICIÓN	ESPECIFICACIÓN	Ø SUPERIOR	Ø INFERIOR	ALTURA	No. BUFALO
02 - 08	CAJA	DER / IZQ / TRIPOIDE	2.4	8.2	8.5	MC-S-904



MC-S-904

## CORDOBA

C M

MODELO	POSICIÓN	ESPECIFICACIÓN	Ø SUPERIOR	Ø INFERIOR	ALTURA	No. BUFALO
02 - 05	RUEDA	DER / IZQ	2.3	8.3	9.5	MC-S-901
	CAJA	DER / IZQ	2.4	6.8	11.7	MC-S-902
	DIRECCIÓN	DER / IZQ / HIDRÁULICA	1.3	4.1	17.5	MC-S-903



MC-S-901

MC-S-902

MC-S-903

## IBIZA

C M

MODELO	POSICIÓN	ESPECIFICACIÓN	Ø SUPERIOR	Ø INFERIOR	ALTURA	No. BUFALO
01 - 05	RUEDA	DER / IZQ	2.0	7.8	8.4	MC-S-900
	CAJA	DER / IZQ	2.4	6.8	11.7	MC-S-902
	DIRECCIÓN	DER / IZQ / HIDRÁULICA	1.3	4.1	17.5	MC-S-903



MC-S-900

MC-S-902

MC-S-903

LEÓN			C M			
MODELO	POSICIÓN	ESPECIFICACIÓN	Ø SUPERIOR	Ø INFERIOR	ALTURA	No. <i>BUFALO</i>
01 - 05	RUEDA	DER / IZQ	2.0	7.8	8.4	<b>MC-S-900</b>
02 - 08	CAJA	DER / IZQ	2.4	6.8	11.7	<b>MC-S-902</b>
01 - 05	DIRECCIÓN	DER / IZQ / <i>HIDRÁULICA</i>	1.3	4.1	17.5	<b>MC-S-903</b>
06 - 08	RUEDA	DER / IZQ / STD	2.3	8.3	9.5	<b>MC-S-901</b>



TOLEDO			C M			
MODELO	POSICIÓN	ESPECIFICACIÓN	Ø SUPERIOR	Ø INFERIOR	ALTURA	No. <i>BUFALO</i>
01 - 05	RUEDA	DER / IZQ	2.0	7.8	8.4	<b>MC-S-900</b>
02 - 08	CAJA	DER / IZQ	2.4	6.8	11.7	<b>MC-S-902</b>
01 - 05	DIRECCIÓN	DER / IZQ / <i>HIDRÁULICA</i>	1.3	4.1	17.5	<b>MC-S-903</b>
06 - 08	RUEDA	DER / IZQ / STD	2.3	8.3	9.5	<b>MC-S-901</b>





MR

# TOYOTA

AUTOS Y CAMIONETAS

CAMIONETAS PICK UP 4 X 4			C M			
MODELO	POSICIÓN	ESPECIFICACIÓN	Ø SUPERIOR	Ø INFERIOR	ALTURA	No. BUFALO
84 - 05	RUEDA	DER / IZQ	2.8	9.5	10.1	MC-T-1100
	RUEDA	DER / IZQ	2.6	9.0	8.2	MC-T-1101
	CAJA	DER / IZQ	2.7	8.4	10.4	MC-T-1102



TACOMA			C M			
MODELO	POSICIÓN	ESPECIFICACIÓN	Ø SUPERIOR	Ø INFERIOR	ALTURA	No. BUFALO
98 - 09	RUEDA	DER / IZQ	2.5	9.1	10.5	MC-T-1104
	CAJA	DER / IZQ / TRIPOIDE	2.2	8.7	9.9	MC-T-1105
00 - 04	DIRECCIÓN	DER / IZQ	2.8	5.7	20.4	MC-T-1103
	DIRECCIÓN	DER / IZQ / CORTA	1.4	4.4	16.2	MC-T-1106



# UNIVERSALES

AUTOS Y CAMIONETAS

UNIVERSALES			C M			
MODELO	POSICIÓN	ESPECIFICACIÓN	Ø SUPERIOR	Ø INFERIOR	ALTURA	No. BUFALO
VARIOS	RUEDA	DER / IZQ / BOCA GRANDE	2.5	8.0	7.0	MC-UA-501
	RUEDA	DER / IZQ	2.2	8.0	7.0	MC-UA-501-A
	CAJA	DER / IZQ / STD	2.5	6.7	11.6	MC-UA-500
	CAJA	DER / IZQ / BOCA GRANDE	2.2	7.1	10.9	MC-UA-500-A
	RUEDA	DER / IZQ / GRANDE	2.3	10.8	15.3	MC-UA-503

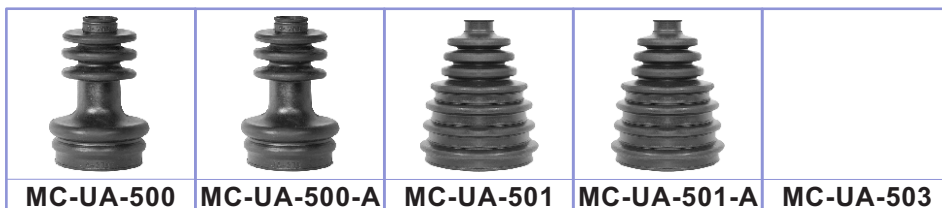



UNIVERSALES CAMIONETAS AMERICANAS			C M			No. BUFALO
MODELO	POSICIÓN	ESPECIFICACIÓN	Ø SUPERIOR	Ø INFERIOR	ALTURA	
VARIOS	RUEDA	DER / IZQ	3.3	11.3	10.8	<b>MC-UA-502</b>



**MC-UA-502**

# VOLKSWAGEN

AUTOS Y CAMIONETAS

BEETLE			C M			No. BUFALO
MODELO	POSICIÓN	ESPECIFICACIÓN	Ø SUPERIOR	Ø INFERIOR	ALTURA	
98 - 08	RUEDA	DER / IZQ	2.3	8.3	9.5	<b>MC-V-111</b>
	CAJA	DER / IZQ / STD	2.2	6.7	10.2	<b>MC-V-118</b>
	CAJA	DER / IZQ / AUT	2.2	8.3	9.1	<b>MC-V-117</b>
	DIRECCIÓN	DER / IZQ / HIDRÁULICA	1.3	4.1	17.5	<b>MC-V-104</b>

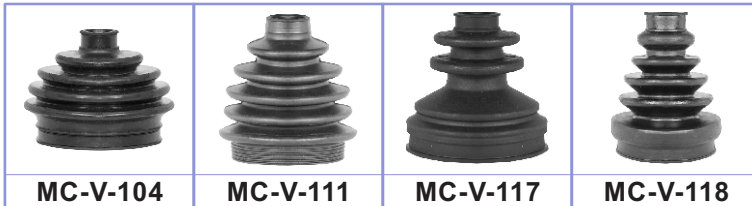

**MC-V-104**

**MC-V-111**

**MC-V-117**

**MC-V-118**

BORA			C M			No. BUFALO
MODELO	POSICIÓN	ESPECIFICACIÓN	Ø SUPERIOR	Ø INFERIOR	ALTURA	
06 - 07	RUEDA	DER / IZQ	2.5	8.8	9.6	<b>MC-V-122</b>
	CAJA	DER / IZQ	2.4	8.4	10.0	<b>MC-V-123</b>
	CAJA	DER / IZQ	2.4	8.4	11.5	<b>MC-V-124</b>
08 - 10	RUEDA	DER / IZQ	3.1	9.9	11.4	<b>MC-V-125</b>
	CAJA	DER / IZQ	2.4	8.2	10.5	<b>MC-V-121</b>



**MC-V-121**

**MC-V-122**

**MC-V-123**

**MC-V-124**

**MC-V-125**



# VOLKSWAGEN

**AUTOS Y CAMIONETAS**

## CARIBE, ATLANTIC

MODELO	POSICIÓN	ESPECIFICACIÓN	Ø SUPERIOR	Ø INFERIOR	ALTURA	No. BUFALO
77 - 87	RUEDA	DER / IZQ	2.0	7.8	8.4	<b>MC-V-104</b>
	CAJA	DER / IZQ	2.4	5.9	8.8	<b>MC-V-105</b>
	DIRECCIÓN	DER / IZQ	2.5	4.1	14.0	<b>MC-V-100</b>
	DIRECCIÓN	DER / IZQ	2.5	3.5	14.0	<b>MC-V-101</b>

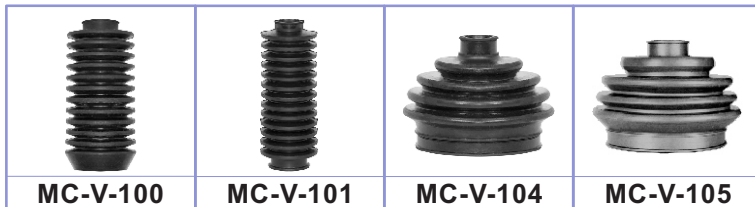

## COMBI, CARAVELLE

MODELO	POSICIÓN	ESPECIFICACIÓN	Ø SUPERIOR	Ø INFERIOR	ALTURA	No. BUFALO
70 - 01	CAJA	DER / IZQ	2.0	6.8	9.6	<b>MC-V-108</b>

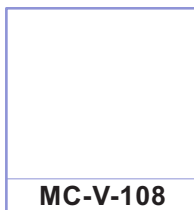

## CORSA

MODELO	POSICIÓN	ESPECIFICACIÓN	Ø SUPERIOR	Ø INFERIOR	ALTURA	No. BUFALO
85 - 87	RUEDA	DER / IZQ	2.0	7.8	8.4	<b>MC-V-104</b>
	CAJA	DER / IZQ	2.4	5.9	8.8	<b>MC-V-105</b>



## DERBY

MODELO	POSICIÓN	ESPECIFICACIÓN	Ø SUPERIOR	Ø INFERIOR	ALTURA	No. BUFALO
95 - 09	RUEDA	DER / IZQ	2.3	8.3	9.5	<b>MC-V-111</b>
	CAJA	DER / IZQ	3.7	6.8	11.0	<b>MC-V-110</b>

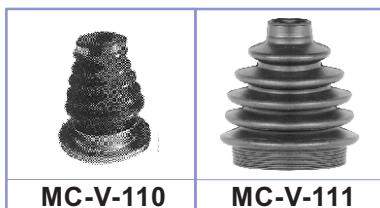

## EUROVAN

MODELO	POSICIÓN	ESPECIFICACIÓN	Ø SUPERIOR	Ø INFERIOR	ALTURA	No. BUFALO
00 - 09	RUEDA	DER / IZQ	2.9	9.4	12.9	<b>MC-V-114</b>
	CAJA	DER / IZQ	2.5	5.7	9.6	<b>MC-V-115</b>
	DIRECCIÓN	DER / IZQ	2.5	5.4	13.4	<b>MC-V-116</b>

## EUROVAN DIESEL

MODELO	POSICIÓN	ESPECIFICACIÓN	Ø SUPERIOR	Ø INFERIOR	ALTURA	No. BUFALO
	RUEDA	DER / IZQ	2.9	10.0	13.5	<b>MC-V-127</b>



**MC-V-114**

**MC-V-115**

**MC-V-116**



**MC-V-127**

## GOLF A2, JETTA A2

MODELO	POSICIÓN	ESPECIFICACIÓN	Ø SUPERIOR	Ø INFERIOR	ALTURA	No. BUFALO
87 - 92	RUEDA	DER / IZQ	2.2	7.8	8.1	<b>MC-V-106</b>
	CAJA	DER / IZQ	2.4	5.9	8.8	<b>MC-V-105</b>
	DIRECCIÓN	DER / IZQ / STD	2.5	3.9	12.1	<b>MC-V-102</b>
	DIRECCIÓN	DER / IZQ / HIDRÁULICA	1.3	4.1	17.5	<b>MC-V-103</b>

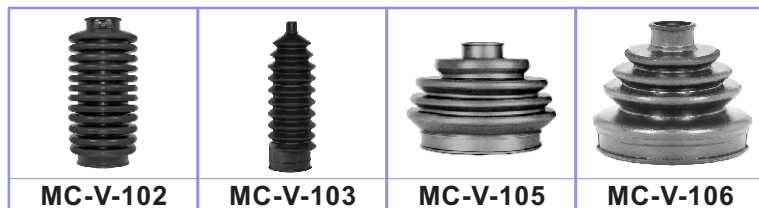

**MC-V-102**

**MC-V-103**

**MC-V-105**

**MC-V-106**

## GOLF A3, JETTA A3

MODELO	POSICIÓN	ESPECIFICACIÓN	Ø SUPERIOR	Ø INFERIOR	ALTURA	No. BUFALO
92 - 99	RUEDA	DER / IZQ	2.3	8.3	9.5	<b>MC-V-111</b>
	CAJA	IZQ	2.4	6.8	11.7	<b>MC-V-112</b>
	CAJA	DER	3.7	6.8	11.0	<b>MC-V-110</b>
	DIRECCIÓN	DER / IZQ / STD	2.5	3.9	12.1	<b>MC-V-102</b>
	DIRECCIÓN	DER / IZQ / HIDRÁULICA	1.3	4.1	17.5	<b>MC-V-103</b>



**MC-V-102**

**MC-V-103**

**MC-V-110**

**MC-V-111**

**MC-V-112**



# VOLKSWAGEN

**AUTOS Y CAMIONETAS**

GOLF A4, JETTA A4			C M			No. BUFALO
MODELO	POSICIÓN	ESPECIFICACIÓN	Ø SUPERIOR	Ø INFERIOR	ALTURA	
98 - 10	RUEDA	DER / IZQ	2.3	8.3	9.5	<b>MC-V-111</b>
98 - 06	CAJA	DER / IZQ / STD	2.2	6.7	10.2	<b>MC-V-118</b>
	CAJA	DER / IZQ / AUT	2.2	8.3	9.1	<b>MC-V-117</b>
07 - 10	CAJA	DER / IZQ / TRIPOIDE	2.4	8.2	10.5	<b>MC-V-121</b>
	CAJA	DER / IZQ	3.7	6.8	11.0	<b>MC-V-110</b>
	CAJA	DER / IZQ / CORTA	2.4	6.8	11.7	<b>MC-V-112</b>
98 - 04	DIRECCIÓN	DER / IZQ / CORTA	1.3	4.9	16.6	<b>MC-V-113</b>
05 - 09	DIRECCIÓN	DER / IZQ / CORTA	1.5	4.5	18.4	<b>MC-V-119</b>



GOLF VR6, JETTA VR6			C M			No. BUFALO
MODELO	POSICIÓN	ESPECIFICACIÓN	Ø SUPERIOR	Ø INFERIOR	ALTURA	
96 - 04	RUEDA	DER / IZQ	2.3	8.3	9.5	<b>MC-V-111</b>
	CAJA	IZQ	2.1	6.8	11.6	<b>MC-V-109</b>
	CAJA	IZQ	2.4	6.8	11.7	<b>MC-V-112</b>
	CAJA	DER	3.7	6.0	11.0	<b>MC-V-110</b>
96 - 99	DIRECCIÓN	DER / IZQ / STD	2.5	3.9	12.1	<b>MC-V-102</b>
00 - 04	DIRECCIÓN	DER / IZQ / HIDRÁULICA	1.3	4.1	17.5	<b>MC-V-103</b>
	DIRECCIÓN	DER / IZQ	1.3	4.9	16.6	<b>MC-V-113</b>



POINTER			C M			No. BUFALO
MODELO	POSICIÓN	ESPECIFICACIÓN	Ø SUPERIOR	Ø INFERIOR	ALTURA	
97 - 09	RUEDA	DER / IZQ	2.0	7.8	8.4	<b>MC-V-104</b>
	CAJA	IZQ	2.4	5.9	8.8	<b>MC-V-105</b>
	DIRECCIÓN	DER / IZQ	2.3	4.2	14.0	<b>MC-V-120</b>

CONTINÚA...

## POINTER



MC-V-104

MC-V-105

MC-V-120

## SHARAN

		C M				
MODELO	POSICIÓN	ESPECIFICACIÓN	Ø SUPERIOR	Ø INFERIOR	ALTURA	No. <i>BUFALO</i>
02 - 08	CAJA	DER / IZQ / TRIPOIDE	2.4	8.2	8.5	<b>MC-V-124</b>



MC-V-124

## VW SEDAN

		C M				
MODELO	POSICIÓN	ESPECIFICACIÓN	Ø SUPERIOR	Ø INFERIOR	ALTURA	No. <i>BUFALO</i>
70 - 04	CAJA	DER / IZQ	4.6	8.5	12.9	<b>MC-V-107</b>



MC-V-107

# **BUFALO AHM**

---

## **CATÁLOGO**



MR

**MACCHETAS**

---



# M A C H E T A S

## INDICE



<b>CHEVROLET</b> .....	<b>5</b>	<b>NISSAN</b> .....	<b>23</b>
ASTRA .....	5	ALMERA .....	23
AMERICANOS .....		APRIO .....	23
AVEO .....		CAMIONETAS AMERICANAS 4 X 4 .....	
BLAZER .....		QUEST .....	
BLAZER JIMMY .....	6	MAXIMA .....	24
CAVALIER / Z-24 .....		MICRA .....	
CAMIONETAS .....		PLATINA .....	
CELEBRITY .....		SENTRA / LUCINO .....	25
CENTURY .....	7	TIIDA .....	
CHEVY / MONZA / C2 .....		TSUBAME .....	
CITATION / X-11 .....	8	TSURU I .....	26
CORSA .....		TSURU II .....	
CUTLASS .....		TSURU III .....	
MATIZ / MATIZ G2 .....	9	X-TERRA / X-TRAIL .....	27
MERIVA .....		URBAN .....	
SAFARI .....			
TORNADO .....		PEUGEOT .....	28
VENTURE .....	10	206 .....	28
ZAFIRA .....			
		RENAULT .....	28
<b>CHRYSLER</b> .....	<b>11</b>	ALIANCE / ENCORE .....	28
ATOS .....	11	CLIO .....	
CAMIONETAS AMERICANAS .....		R-5 .....	29
CIRRUS .....		R-12 .....	
DART K .....		R-18 .....	
LEBARON .....	12	MEGANE I, II .....	
NEON .....			
NEW YORKER .....		SEAT .....	30
PHANTOM / SHADOW .....	13	ALHAMBRA .....	30
SPIRIT .....		CORDOBA .....	
STRATUS .....	14	IBIZA .....	
VERNA .....		LEÓN .....	31
VOLARE .....		TOLEDO .....	
VOYAGER .....			
		TOYOTA .....	32
<b>FORD</b> .....	<b>15</b>	CAMIONETAS PICK UP 4 X 4 .....	32
AEROSTAR .....	15	TACOMA .....	
AMERICANOS .....			
CONTOUR .....		UNIVERSALES .....	32
COUGAR .....	16	UNIVERSALES CAMIONETAS AMERICANAS .....	33
COURIER .....			
ECOSPORT .....		VOLKSWAGEN .....	33
ESCORT .....		BEETLE .....	33
EXPLORER .....	17	BORA .....	
F-150 / F-350 .....		CARIBE / ATLANTIC .....	34
FAIRMONT .....		COMBI / CARAVELLE .....	
FIESTA .....		CORSA .....	
FOCUS .....	18	DERBY .....	
GUIA .....		EUROVAN .....	35
IKON .....		EUROVAN DIESEL .....	
KA .....		GOLF A2 / JETTA A2 .....	
MONDEO .....	19	GOLF A3 / JETTA A3 .....	
MYSTIQUE .....		GOLF A4 / JETTA A4 .....	36
MUSTANG .....		GOLF VR6 / JETTA VR6 .....	
RANGER .....	20	POINTER .....	
TAURUS .....		SHARAN .....	37
TOPAZ .....		VW SEDÁN .....	
WINDSTAR .....	21		
<b>HONDA</b> .....	<b>22</b>		
ACCORD .....	22		
CIVIC .....			
CR-V .....			





MR

# CALIDAD Y GARANTÍA DE EXPORTACIÓN

**NOTA: TODAS LAS FOTOGRAFÍAS USADAS TIENEN UN FIN  
ILUSTRATIVO Y NO CORRESPONDEN AL TAMAÑO ORIGINAL.  
( PARA MAYORES INFORMES ACERCA DE CUALQUIER PRODUCTO,  
CONSULTE A SU DISTRIBUIDOR AUTORIZADO)**

ASTRA		C M				
MODELO	POSICIÓN	ESPECIFICACIÓN	Ø SUPERIOR	Ø INFERIOR	ALTURA	No. <i>BUFALO</i>
00 - 08	RUEDA	DER / IZQ	2.0	7.0	10.2	<b>MC-G-726</b>
	CAJA	DER / IZQ	2.6	6.6	9.5	<b>MC-G-727</b>



**MC-G-726**

**MC-G-727**

AMERICANOS		C M				
MODELO	POSICIÓN	ESPECIFICACIÓN	Ø SUPERIOR	Ø INFERIOR	ALTURA	No. <i>BUFALO</i>
	RUEDA	DER / IZQ / TRIPOIDE	2.7	8.7	8.9	<b>MC-G-714</b>
	CAJA	DER / IZQ / TRIPOIDE / <i>CHICO</i>	2.0	7.5	10.2	<b>MC-G-713</b>
	CAJA	DER / IZQ / TRIPOIDE / <i>MEDIANO</i>	2.5	8.5	10.8	<b>MC-G-712</b>
	CAJA	DER / IZQ / TRIPOIDE / <i>GRANDE</i>	2.4	9.3	10.1	<b>MC-G-711</b>
	CAJA	DER / IZQ / TRIPOIDE / <i>EXTRAGRANDE</i>	2.3	9.1	10.3	<b>MC-G-719</b>



**MC-G-711**

**MC-G-712**

**MC-G-713**

**MC-G-714**

**MC-G-719**

AVEO		C M				
MODELO	POSICIÓN	ESPECIFICACIÓN	Ø SUPERIOR	Ø INFERIOR	ALTURA	No. <i>BUFALO</i>
04 - 11	DIRECCIÓN	DER / IZQ	2.5	9	12.8	<b>MC-G-738</b>

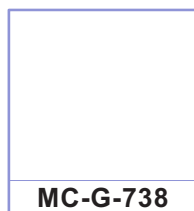

**MC-G-738**

BLAZER		C M				
MODELO	POSICIÓN	ESPECIFICACIÓN	Ø SUPERIOR	Ø INFERIOR	ALTURA	No. <i>BUFALO</i>
97 - 00	RUEDA	DER / IZQ	2.5	9	12.8	<b>MC-G-717</b>



**MC-G-717**



# CHEVROLET

**AUTOS Y CAMIONETAS**

BLAZER JIMMY			C M			No. BUFALO
MODELO	POSICIÓN	ESPECIFICACIÓN	Ø SUPERIOR	Ø INFERIOR	ALTURA	
	RUEDA	DER / IZQ	2.8	10.0	13.0	<b>MC-G-736</b>
	CAJA	DER / IZQ	2.8	9.3	13.0	<b>MC-G-737</b>



CAVALIER / Z-24			C M			No. BUFALO
MODELO	POSICIÓN	ESPECIFICACIÓN	Ø SUPERIOR	Ø INFERIOR	ALTURA	
90 - 05	RUEDA	DER / IZQ	2.3	8.0	10.0	<b>MC-G-705</b>
90 - 96	CAJA	DER / IZQ	2.3	8.3	10.6	<b>MC-G-704</b>
97 - 05	CAJA	DER / IZQ / TRIPOIDE	2.4	9.3	10.1	<b>MC-G-711</b>
90 - 05	DIRECCIÓN	CENTRAL	5.5	6.5	4.5	<b>MC-G-734</b>



CAMIONETAS			C M			No. BUFALO
MODELO	POSICIÓN	ESPECIFICACIÓN	Ø SUPERIOR	Ø INFERIOR	ALTURA	
00 - 10	RUEDA	DER / IZQ	2.5	9.0	12.8	<b>MC-G-717</b>
	DIR. HIDRA.	DER / IZQ	1.3	5.0	20.2	<b>MC-G-728</b>



CELEBRITY			C M			No. BUFALO
MODELO	POSICIÓN	ESPECIFICACIÓN	Ø SUPERIOR	Ø INFERIOR	ALTURA	
83 - 90	RUEDA	DER / IZQ	2.2	8.0	7.0	<b>MC-G-710</b>
	CAJA	DER / IZQ	2.5	6.7	11.6	<b>MC-G-709</b>
82	CAJA	DER / IZQ	2.3	8.3	10.4	<b>MC-G-700</b>
82 - 90	CAJA	DER / IZQ	2.3	8.9	10.0	<b>MC-G-701</b>
	CAJA	DER / IZQ / TRIPOIDE	2.4	9.3	10.1	<b>MC-G-711</b>
	DIR. HIDRA.	DER / IZQ	1.6	4.7	18.5	<b>MC-G-706</b>
	DIR. STD.	DER / IZQ	1.1	4.7	18.5	<b>MC-G-708</b>

CONTINÚA...

## CELEBRITY

						
<b>MC-G-700</b>	<b>MC-G-701</b>	<b>MC-G-706</b>	<b>MC-G-708</b>	<b>MC-G-709</b>	<b>MC-G-710</b>	<b>MC-G-711</b>

## CENTURY

		C M				
MODELO	POSICIÓN	ESPECIFICACIÓN	Ø SUPERIOR	Ø INFERIOR	ALTURA	No. <i>BUFALO</i>
83 - 90	RUEDA	DER / IZQ	2.2	8.0	7.0	<b>MC-G-710</b>
	CAJA	DER / IZQ	2.5	6.7	11.6	<b>MC-G-709</b>
	CAJA	DER / IZQ	2.3	8.9	10.0	<b>MC-G-701</b>
91 - 95	RUEDA	DER / IZQ	2.3	8.0	10.0	<b>MC-G-705</b>
	CAJA	DER / IZQ	2.3	8.3	10.6	<b>MC-G-704</b>

				
<b>MC-G-701</b>	<b>MC-G-704</b>	<b>MC-G-705</b>	<b>MC-G-709</b>	<b>MC-G-710</b>

## CHEVY MONZA C2 MONZA, CHEVY C2

		C M				
MODELO	POSICIÓN	ESPECIFICACIÓN	Ø SUPERIOR	Ø INFERIOR	ALTURA	No. <i>BUFALO</i>
94 - 00	RUEDA	DER / IZQ	2.4	7.9	10.4	<b>MC-G-715</b>
94 - 99	CAJA	DER / IZQ	1.9	7.6	10.4	<b>MC-G-718</b>
97 - 00	CAJA	DER / IZQ	2.2	7.0	12.0	<b>MC-G-731</b>
00 - 10	CAJA STD.	DER / IZQ / TRIPOIDE	2.0	7.5	10.2	<b>MC-G-720</b>
	CAJA AUT.	DER / IZQ / TRIPOIDE	1.9	7.6	10.4	<b>MC-G-735</b>
94 - 10	DIR. STD.	DER / IZQ	1.2	4.7	15.5	<b>MC-G-716</b>
	DIR. HIDRA.	DER / IZQ	1.3	4.9	17	<b>MC-G-729</b>
10 - 11	DIR. STD.	DER / IZQ	1.5	4.2	16	<b>MC-G-739</b>

						
<b>MC-G-715</b>	<b>MC-G-716</b>	<b>MC-G-718</b>	<b>MC-G-720</b>	<b>MC-G-729</b>	<b>MC-G-731</b>	<b>MC-G-735</b>

<b>MC-G-739</b>



# CHEVROLET

AUTOS Y CAMIONETAS

CITATION, X-11			C M			
MODELO	POSICIÓN	ESPECIFICACIÓN	Ø SUPERIOR	Ø INFERIOR	ALTURA	No. BUFALO
83 - 88	RUEDA	DER / IZQ	2.2	8.0	7.0	<b>MC-G-710</b>
	CAJA	DER / IZQ	2.5	6.7	11.6	<b>MC-G-709</b>
82	DIR. HIDRA.	DER / IZQ	2.3	8.3	16.4	<b>MC-G-700</b>
82 - 90	RUEDA	DER / IZQ	2.3	8.9	10.0	<b>MC-G-701</b>
	CAJA	DER / IZQ	1.6	4.7	18.5	<b>MC-G-706</b>
	CAJA	DER / IZQ	1.1	4.7	18.2	<b>MC-G-708</b>



CORSA			C M			
MODELO	POSICIÓN	ESPECIFICACIÓN	Ø SUPERIOR	Ø INFERIOR	ALTURA	No. BUFALO
02 - 08	RUEDA	DER / IZQ	2.2	7.8	11.7	<b>MC-G-724</b>
	CAJA	DER / IZQ	2.2	7.6	9.8	<b>MC-G-725</b>
	DIR. HIDRA.	DER / IZQ	1.3	4.9	17	<b>MC-G-729</b>



CUTLASS			C M			
MODELO	POSICIÓN	ESPECIFICACIÓN	Ø SUPERIOR	Ø INFERIOR	ALTURA	No. BUFALO
87 - 90	RUEDA	DER / IZQ	2.6	8.9	13.9	<b>MC-G-702</b>
	CAJA	DER / IZQ	2.3	8.9	10.0	<b>MC-G-701</b>
	CAJA	DER / IZQ	2.1	9.6	14.0	<b>MC-G-703</b>
91 - 95	RUEDA	DER / IZQ	2.3	8.0	10.0	<b>MC-G-705</b>
	CAJA	DER / IZQ	2.3	8.3	10.6	<b>MC-G-704</b>
87 - 95	DIR. HIDRA.	DER / IZQ	1.2	5.9	15.8	<b>MC-G-707</b>



MATIZ, MATIZ G2			C M			
MODELO	POSICIÓN	ESPECIFICACIÓN	Ø SUPERIOR	Ø INFERIOR	ALTURA	No. <i>BUFALO</i>
04 - 10	RUEDA	DER / IZQ	2.1	6.7	8.5	<b>MC-G-722</b>
	CAJA	DER / IZQ / TRIPOIDE	2.1	6.6	8.2	<b>MC-G-723</b>
	DIRECCIÓN	DER / IZQ	0.9	4.2	17.5	<b>MC-G-730</b>



MERIVA			C M			
MODELO	POSICIÓN	ESPECIFICACIÓN	Ø SUPERIOR	Ø INFERIOR	ALTURA	No. <i>BUFALO</i>
02 - 08	RUEDA	DER / IZQ	2.2	7.8	11.7	<b>MC-G-724</b>
	CAJA	DER / IZQ	2.6	6.6	9.5	<b>MC-G-727</b>



SAFARI			C M			
MODELO	POSICIÓN	ESPECIFICACIÓN	Ø SUPERIOR	Ø INFERIOR	ALTURA	No. <i>BUFALO</i>
	RUEDA	DER / IZQ	2.8	10.0	13.0	<b>MC-G-736</b>
	CAJA	DER / IZQ	2.8	9.3	13.0	<b>MC-G-737</b>



TORNADO			C M			
MODELO	POSICIÓN	ESPECIFICACIÓN	Ø SUPERIOR	Ø INFERIOR	ALTURA	No. <i>BUFALO</i>
04 - 11	RUEDA	DER / IZQ	2.5	13.0	13.0	<b>MC-G-732</b>
	CAJA	DER / IZQ	1.8	6.5	10.0	<b>MC-G-733</b>
	DIR. HIDRA.	DER / IZQ	1.3	4.9	17.0	<b>MC-G-729</b>





# CHEVROLET

**AUTOS Y CAMIONETAS**

VENTURE			C M			No. BUFALO
MODELO	POSICIÓN	ESPECIFICACIÓN	Ø SUPERIOR	Ø INFERIOR	ALTURA	
99 - 05	RUEDA	DER / IZQ	2.1	9.6	14.0	<b>MC-G-721</b>



ZAFIRA			C M			No. BUFALO
MODELO	POSICIÓN	ESPECIFICACIÓN	Ø SUPERIOR	Ø INFERIOR	ALTURA	
02 - 06	RUEDA	DER / IZQ	2.2	7.8	11.7	<b>MC-G-724</b>
	CAJA	DER / IZQ	2.6	6.6	9.5	<b>MC-G-727</b>



# CALIDAD Y GARANTÍA

ATOS		C M				
MODELO	POSICIÓN	ESPECIFICACIÓN	Ø SUPERIOR	Ø INFERIOR	ALTURA	No. BUFALO
00 - 11	RUEDA	DER / IZQ	2.3	7.1	8.4	<b>MC-C-419</b>
	CAJA	DER / IZQ / TRIPOIDE	2.0	6.3	8.6	<b>MC-C-420</b>
	DIRECCIÓN	DER / IZQ	1.2	4.2	17.5	<b>MC-C-421</b>



**MC-C-419**

**MC-C-420**

**MC-C-421**

CAMIONETAS AMERICANAS		C M				
MODELO	POSICIÓN	ESPECIFICACIÓN	Ø SUPERIOR	Ø INFERIOR	ALTURA	No. BUFALO
	CAJA	DER / IZQ / BOCA CHICA	4.2	7.3	10.6	<b>MC-C-416</b>
	CAJA	DER / IZQ / BOCA GRANDE	3.8	8.5	8.9	<b>MC-C-417</b>



**MC-C-416**

**MC-C-417**

CIRRUS		C M				
MODELO	POSICIÓN	ESPECIFICACIÓN	Ø SUPERIOR	Ø INFERIOR	ALTURA	No. BUFALO
	RUEDA	DER / IZQ	2.5	7.7	11.4	<b>MC-C-414</b>
	CAJA	DER / IZQ / TRIPOIDE	2.5	8.5	10.8	<b>MC-C-412</b>
95 - 06	CAJA	IZQ	2.4	7.8	10.1	<b>MC-C-413</b>
	DIR. HIDRA.	DER / IZQ	1.5	4.6	19.0	<b>MC-C-415</b>



**MC-C-412**

**MC-C-413**

**MC-C-414**

**MC-C-415**

DART K		C M				
MODELO	POSICIÓN	ESPECIFICACIÓN	Ø SUPERIOR	Ø INFERIOR	ALTURA	No. BUFALO
82 - 89	RUEDA	DER / IZQ	2.4	8.3	8.7	<b>MC-C-401</b>
	CAJA	DER	3.2	4.8	9.5	<b>MC-C-400</b>
	CAJA	IZQ	1.9	7.6	10.4	<b>MC-C-407</b>
	DIR. HIDRA.	DER / IZQ	1.2	4.5	20.8	<b>MC-C-402</b>
	DIR. STD.	DER / IZQ	1.1	4.7	15.5	<b>MC-C-404</b>





# CHEVROLET

AUTOS Y CAMIONETAS

## DART K



## LEBARON

C M

MODELO	POSICIÓN	ESPECIFICACIÓN	Ø SUPERIOR	Ø INFERIOR	ALTURA	No. BUFALO
82 - 89	RUEDA	DER / IZQ	8.7	8.3	8.7	MC-C-401
	CAJA	DER	9.5	4.8	9.5	MC-C-400
	CAJA	IZQ	10.4	7.6	10.4	MC-C-407
	DIR. HIDRA.	DER / IZQ	20.8	4.5	20.8	MC-C-402
	DIR. STD..	DER / IZQ	12.5	5.0	15.5	MC-C-403



## NEON

C M

MODELO	POSICIÓN	ESPECIFICACIÓN	Ø SUPERIOR	Ø INFERIOR	ALTURA	No. BUFALO
	RUEDA	DER / IZQ	2.2	7.7	11.1	MC-C-411
	CAJA	DER / TRIPOIDE	2.0	7.5	10.0	MC-C-409
	CAJA	IZQ	2.4	7.6	9.8	MC-C-410
00 - 07	RUEDA	DER / IZQ	2.4	8.2	9.3	MC-C-430
	CAJA	DER / IZQ / TRIPOIDE	2.1	7.2	10.5	MC-C-427



## NEW YORKER

C M

MODELO	POSICIÓN	ESPECIFICACIÓN	Ø SUPERIOR	Ø INFERIOR	ALTURA	No. BUFALO
	RUEDA	DER / IZQ	2.2	8.0	7.0	MC-C-414
	RUEDA	DER / IZQ	2.5	7.0	8.8	MC-C-412
90 - 95	CAJA	DER / IZQ	2.3	8.3	10.6	MC-C-413
	DIR. HIDRA.	DER / IZQ	1.4	4.5	16.8	MC-C-415

CONTINÚA...

# CHRYSLER

AUTOS Y CAMIONETAS



MR

## NEW YORKER



MC-C-405

MC-C-408

MC-C-418

MC-C-422

## PHANTOM, SHADOW

C M

MODELO	POSICIÓN	ESPECIFICACIÓN	Ø SUPERIOR	Ø INFERIOR	ALTURA	No. BUFALO
88 - 89	RUEDA	DER / IZQ	2.4	8.3	8.7	MC-C-401
	CAJA	DER	3.2	4.8	9.5	MC-C-400
	CAJA	IZQ	1.9	7.6	10.4	MC-C-407
	DIR. HIDRA.	DER / IZQ	1.2	4.5	20.8	MC-C-402
	DIR. STD.	DER / IZQ	1.1	5.0	12.5	MC-C-403
	RUEDA	DER / IZQ	2.2	8.0	7.0	MC-C-406
	RUEDA	DER / IZQ	2.5	7.8	8.8	MC-C-418
90 - 95	CAJA	DER / IZQ	2.3	8.3	10.6	MC-C-408
	DIR. HIDRA.	DER / IZQ	1.4	4.5	16.8	MC-C-405

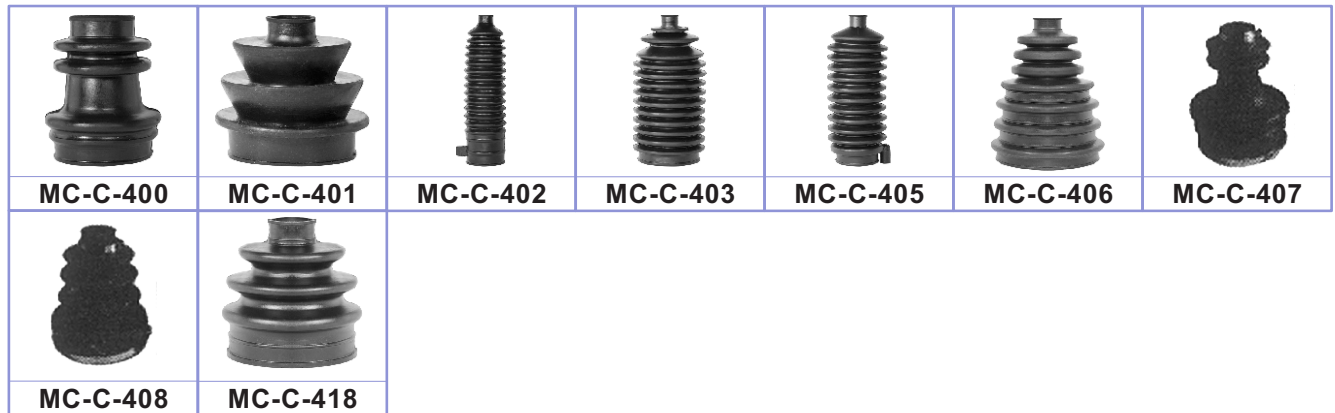

MC-C-400

MC-C-401

MC-C-402

MC-C-403

MC-C-405

MC-C-406

MC-C-407

MC-C-408

MC-C-418

## SPIRIT

C M

MODELO	POSICIÓN	ESPECIFICACIÓN	Ø SUPERIOR	Ø INFERIOR	ALTURA	No. BUFALO
88 - 89	RUEDA	DER / IZQ	2.2	8.0	7.0	MC-C-406
	RUEDA	DER / IZQ	2.5	7.8	8.8	MC-C-418
	CAJA	DER	3.2	4.8	9.5	MC-C-400
90	CAJA	IZQ	1.9	7.6	10.4	MC-C-407
	DIR. HIDRA.	DER / IZQ	1.2	4.5	20.8	MC-C-402
91 - 95	CAJA	DER / IZQ	2.3	8.3	10.6	MC-C-408
	DIR. HIDRA.	DER / IZQ	1.4	4.5	16	MC-C-405



MC-C-400

MC-C-402

MC-C-405

MC-C-406

MC-C-407

MC-C-408

MC-C-418



# CHRYSLER

**AUTOS Y CAMIONETAS**

STRATUS			C M			
MODELO	POSICIÓN	ESPECIFICACIÓN	Ø SUPERIOR	Ø INFERIOR	ALTURA	No. BUFALO
95 - 06	RUEDA	DER / IZQ	2.5	7.7	11.4	MC-C-414
	CAJA	DER / TRIPOIDE	2.5	8.5	10.8	MC-C-412
	CAJA	IZQ	2.4	7.8	10.1	MC-C-413
	DIR. HIDRA.	DER / IZQ	1.5	4.6	19.0	MC-C-415



VERNA			C M			
MODELO	POSICIÓN	ESPECIFICACIÓN	Ø SUPERIOR	Ø INFERIOR	ALTURA	No. BUFALO
04 - 06	RUEDA	DER / IZQ	2.2	7.3	8.5	MC-C-423
	CAJA STD.	DER / IZQ	2.1	6.0	8.2	MC-C-424
	CAJA AUT.	DER / IZQ	2.2	6.8	8.2	MC-C-425
	DIRECCIÓN	DER / IZQ	1.5	4.5	18.5	MC-C-426



VOLARE			C M			
MODELO	POSICIÓN	ESPECIFICACIÓN	Ø SUPERIOR	Ø INFERIOR	ALTURA	No. BUFALO
82 - 89	RUEDA	DER / IZQ	8.3	2.4	8.3	MC-C-401
	CAJA	DER	4.8	3.2	9.5	MC-C-400
	CAJA	IZQ	7.6	1.9	10.4	MC-C-407
	DIR. HIDRA.	DER / IZQ	4.5	1.2	20.8	MC-C-402
	DIR. STD.	DER / IZQ	4.7	1.1	15.5	MC-C-404



VOYAGER			C M			
MODELO	POSICIÓN	ESPECIFICACIÓN	Ø SUPERIOR	Ø INFERIOR	ALTURA	No. BUFALO
95 - 00	RUEDA	DER / IZQ	2.6	9.17	12.7	MC-C-428
	CAJA	DER / TRIPOIDE	2.5	8.5	10.8	MC-C-412
	CAJA	IZQ / TRIPOIDE	2.5	7.8	10.6	MC-C-429

CONTINÚA...

# CHRYSLER

AUTOS Y CAMIONETAS



## VOYAGER



MC-C-412

MC-C-428

MC-C-429

# FORD

AUTOS Y CAMIONETAS

## AEROSTAR

		C M				
MODELO	POSICIÓN	ESPECIFICACIÓN	Ø SUPERIOR	Ø INFERIOR	ALTURA	No. BUFALO
86 - 97	DIR. HIDRA.	DER / IZQ	1.0	5.8	18.8	MC-F-611



MC-F-611

## AMERICANOS

		C M				
MODELO	POSICIÓN	ESPECIFICACIÓN	Ø SUPERIOR	Ø INFERIOR	ALTURA	No. BUFALO
	CAJA	DER / IZQ / TRIPOIDE	2.3	7.8	8.5	MC-F-624



MC-F-624

## CONTOUR

		C M				
MODELO	POSICIÓN	ESPECIFICACIÓN	Ø SUPERIOR	Ø INFERIOR	ALTURA	No. BUFALO
85 - 00	RUEDA	DER / IZQ	2.3	8.3	9.5	MC-F-620



MC-F-620



# F O R D

**AUTOS Y CAMIONETAS**

COUGAR			C M			No. BUFALO
MODELO	POSICIÓN	ESPECIFICACIÓN	Ø SUPERIOR	Ø INFERIOR	ALTURA	
89 - 92	RUEDA	DER / IZQ	2.3	8.0	10.0	MC-F-614
	CAJA	DER / IZQ	2.3	8.3	10.6	MC-F-612
84 - 86	DIR. HIDRA.	DER / IZQ	1.1	5.3	14.8	MC-F-600
89 - 92	DIR. HIDRA.	DER / IZQ	1.2	5.5	20.2	MC-F-605



COURIER			C M			No. BUFALO
MODELO	POSICIÓN	ESPECIFICACIÓN	Ø SUPERIOR	Ø INFERIOR	ALTURA	
99 - 05	RUEDA	DER / IZQ	2.4	8.0	8.5	MC-F-622
	CAJA	DER / IZQ / TRIPOIDE	1.9	6.9	7.8	MC-F-621



ECOSPORT			C M			No. BUFALO
MODELO	POSICIÓN	ESPECIFICACIÓN	Ø SUPERIOR	Ø INFERIOR	ALTURA	
02 - 11	RUEDA	DER / IZQ	2.4	8.0	8.5	MC-F-622
	CAJA	DER / IZQ	2.0	7.5	7.8	MC-F-626
	DIRECCIÓN	DER / IZQ	1.3	5.3	19.1	MC-F-625



ESCORT			C M			No. BUFALO
MODELO	POSICIÓN	ESPECIFICACIÓN	Ø SUPERIOR	Ø INFERIOR	ALTURA	
97 - 02	CAJA	DER / IZQ	2.2	7.3	9.5	MC-F-616
	RUEDA	DER / IZQ	1.9	6.8	8.5	MC-F-617



EXPLORER		C M				No. BUFALO
MODELO	POSICIÓN	ESPECIFICACIÓN	Ø SUPERIOR	Ø INFERIOR	ALTURA	
96 - 07	DIR. HIDRA.	DER / IZQ	1.3	6.8	19.3	MC-F-628



MC-F-628

F-150, F-350		C M				No. BUFALO
MODELO	POSICIÓN	ESPECIFICACIÓN	Ø SUPERIOR	Ø INFERIOR	ALTURA	
04 - 11	DIR. HIDRA.	DER / IZQ	1.6	5.5	22.9	MC-F-627
	DIR. HIDRA.	DER / IZQ / 4 X 4	8.0	6.5	21.0	MC-F-629



MC-F-627

MC-F-629

FAIRMONT		C M				No. BUFALO
MODELO	POSICIÓN	ESPECIFICACIÓN	Ø SUPERIOR	Ø INFERIOR	ALTURA	
74 - 77	DIR. HIDRA.	DER / IZQ	1.1	4.6	12.4	MC-F-602
78 - 83	DIR. HIDRA.	DER / IZQ	1.1	5.3	14.8	MC-F-600
	DIR. STD	DER / IZQ	1.0	4.5	15.4	MC-F-608



MC-F-600

MC-F-602

MC-F-608

FIESTA		C M				No. BUFALO
MODELO	POSICIÓN	ESPECIFICACIÓN	Ø SUPERIOR	Ø INFERIOR	ALTURA	
98 - 01	CAJA	DER / IZQ / TRIPOIDE	2.5	7.5	12.0	MC-F-618
01 - 06	RUEDA	DER / IZQ	2.4	8	8.5	MC-F-622
	CAJA	DER / IZQ / TRIPOIDE	1.9	6.9	7.8	MC-F-621



MC-F-618

MC-F-621

MC-F-622



# F O R D

**AUTOS Y CAMIONETAS**

FOCUS			C M			No. BUFALO
MODELO	POSICIÓN	ESPECIFICACIÓN	Ø SUPERIOR	Ø INFERIOR	ALTURA	
00 - 05	RUEDA	DER / IZQ	2.4	8.0	8.5	<b>MC-F-622</b>
	CAJA	DER / IZQ / TRIPOIDE	2.5	8.2	10.4	<b>MC-F-623</b>
	DIRECCIÓN	DER / IZQ	1.3	5.3	19.1	<b>MC-F-624</b>
	RUEDA	DER / IZQ	2.5	7.5	10.5	<b>MC-F-631</b>



GUIA			C M			No. BUFALO
MODELO	POSICIÓN	ESPECIFICACIÓN	Ø SUPERIOR	Ø INFERIOR	ALTURA	
91	RUEDA	DER / IZQ	2.2	8.5	7.0	<b>MC-F-610</b>
	CAJA	DER / IZQ	2.5	6.7	12.2	<b>MC-F-609</b>
92 - 94	RUEDA	DER / IZQ	2.3	8.0	10.0	<b>MC-F-614</b>
	CAJA	DER / IZQ	2.3	8.3	10.2	<b>MC-F-612</b>
91 - 94	DIR. HIDRA.	DER / IZQ	1.0	5.8	18.8	<b>MC-F-611</b>



IKON			C M			No. BUFALO
MODELO	POSICIÓN	ESPECIFICACIÓN	Ø SUPERIOR	Ø INFERIOR	ALTURA	
01 - 06	RUEDA	DER / IZQ	2.4	8.0	8.5	<b>MC-F-622</b>
	CAJA	DER / IZQ / TRIPOIDE	1.9	6.9	7.8	<b>MC-F-621</b>



KA			C M			No. BUFALO
MODELO	POSICIÓN	ESPECIFICACIÓN	Ø SUPERIOR	Ø INFERIOR	ALTURA	
01 - 06	RUEDA	DER / IZQ	2.4	8.0	8.5	<b>MC-F-622</b>
	CAJA	DER / IZQ / TRIPOIDE	1.9	6.9	7.8	<b>MC-F-621</b>

CONTINÚA...

# F O R D

**AUTOS Y CAMIONETAS**



**KA**



**MC-F-621**



**MC-F-622**

**MONDEO**

C M

MODELO	POSICIÓN	ESPECIFICACIÓN	Ø SUPERIOR	Ø INFERIOR	ALTURA	No. <i>BUFALO</i>
99 - 05	RUEDA	DER / IZQ	2.4	8.0	8.5	<b>MC-F-622</b>
	CAJA	DER / IZQ / TRIPOIDE	2.5	8.2	10.4	<b>MC-F-623</b>
	DIRECCIÓN	DER / IZQ	1.3	5.3	19.1	<b>MC-F-625</b>



**MC-F-622**



**MC-F-623**



**MC-F-625**

**MYSTIQUE**

C M

MODELO	POSICIÓN	ESPECIFICACIÓN	Ø SUPERIOR	Ø INFERIOR	ALTURA	No. <i>BUFALO</i>
95 - 00	RUEDA	DER / IZQ	2.3	8.3	9.5	<b>MC-F-620</b>



**MC-F-620**

**MUSTANG**

C M

MODELO	POSICIÓN	ESPECIFICACIÓN	Ø SUPERIOR	Ø INFERIOR	ALTURA	No. <i>BUFALO</i>
74 - 77	DIRECCIÓN	DER / IZQ	1.1	4.6	12.4	<b>MC-F-602</b>
78 - 83	DIR. HIDRA.	DER / IZQ	1.2	4.6	19.5	<b>MC-F-601</b>



**MC-F-601**



**MC-F-602**





# F O R D

**AUTOS Y CAMIONETAS**

RANGER			C M			No. BUFALO
MODELO	POSICIÓN	ESPECIFICACIÓN	Ø SUPERIOR	Ø INFERIOR	ALTURA	
96 - 07	DIR. HIDRA.	DER / IZQ	1.3	6.8	19.3	<b>MC-F-628</b>



TAURUS			C M			No. BUFALO
MODELO	POSICIÓN	ESPECIFICACIÓN	Ø SUPERIOR	Ø INFERIOR	ALTURA	
88 - 91	RUEDA	DER / IZQ	2.3	8.0	10.0	<b>MC-F-614</b>
	CAJA	DER / IZQ	2.3	8.3	10.6	<b>MC-F-612</b>
	DIR. HIDRA.	DER / IZQ	1.2	5.5	20.2	<b>MC-F-605</b>



TOPAZ			C M			No. BUFALO
MODELO	POSICIÓN	ESPECIFICACIÓN	Ø SUPERIOR	Ø INFERIOR	ALTURA	
84 - 90	RUEDA	DER / IZQ	2.2	8.5	7.0	<b>MC-F-610</b>
	CAJA	DER / IZQ	2.5	6.7	12.2	<b>MC-F-609</b>
	DIR. STD.	DER / IZQ	1.2	3.0	17.2	<b>MC-F-603</b>
	DIR. STD.	DER / IZQ	1.1	4.5	14.9	<b>MC-F-607</b>
	DIR. HIDRA.	DER / IZQ	1.0	4.4	21.2	<b>MC-F-604</b>
91 - 94	RUEDA	DER / IZQ	2.2	7.2	7.9	<b>MC-F-613</b>
	CAJA	DER / IZQ	2.6	8.9	11.9	<b>MC-F-615</b>
	DIR. HIDRA.	DER / IZQ	1.0	5.8	18.8	<b>MC-F-611</b>



# F O R D

**AUTOS Y CAMIONETAS**



WINDSTAR		C M					No. <i>BUFALO</i>
MODELO	POSICIÓN	ESPECIFICACIÓN	Ø SUPERIOR	Ø INFERIOR	ALTURA		
95 - 00	RUEDA	DER / IZQ	2.15	8.7	2.16	<b>MC-F-630</b>	
	CAJA	DER / IZQ	2.3	6.7	10.6	<b>MC-F-612</b>	
95 - 03	DIR. HIDRA.	DER / IZQ	1.0	5.8	18.8	<b>MC-F-611</b>	
04 - 08	DIR. HIDRA.	DER / IZQ	1.3	6.8	19.3	<b>MC-F-628</b>	



# CALIDAD Y GARANTÍA DE EXPORTACIÓN



# H O N D A

**AUTOS Y CAMIONETAS**

ACCORD			C M			
MODELO	POSICIÓN	ESPECIFICACIÓN	Ø SUPERIOR	Ø INFERIOR	ALTURA	No. BUFALO
97 - 02	RUEDA	DER / IZQ	2.4	7.9	10.4	<b>MC-H-801</b>
	CAJA	DER / IZQ / TRIPOIDE	2.4	7.8	8.8	<b>MC-H-800</b>
03 - 06	RUEDA	DER / IZQ	2.4	8.6	11.6	<b>MC-H-805</b>
	CAJA	DER / IZQ / TRIPOIDE	2.1	7.4	8.2	<b>MC-H-803</b>
97 - 06	DIR. HIDRA.	DER / IZQ	1.0	4.0	16.5	<b>MC-H-802</b>
	DIRECCIÓN	DER / IZA / CORTA	0.9	4.0	14.0	<b>MC-H-804</b>



CIVIC			C M			
MODELO	POSICIÓN	ESPECIFICACIÓN	Ø SUPERIOR	Ø INFERIOR	ALTURA	No. BUFALO
97 - 02	RUEDA	DER / IZQ	2.4	7.9	10.4	<b>MC-H-801</b>
	CAJA	DER / IZQ / TRIPOIDE	2.4	7.8	8.8	<b>MC-H-800</b>
97 - 06	CAJA	DER / IZQ / TRIPOIDE	2.1	7.4	8.2	<b>MC-H-803</b>
	DIR. HIDRA.	DER / IZQ	1.0	4.0	16.5	<b>MC-H-802</b>
	DIRECCIÓN	DER / IZQ / CORTA	0.9	4.0	14.0	<b>MC-H-804</b>



CR - V			C M			
MODELO	POSICIÓN	ESPECIFICACIÓN	Ø SUPERIOR	Ø INFERIOR	ALTURA	No. BUFALO
03 - 06	RUEDA	DER / IZQ	2.3	8.3	9.5	<b>MC-H-807</b>
	CAJA	DER / IZQ / TRIPOIDE	2.1	8.5	8.2	<b>MC-H-808</b>



ALMERA		C M				No. BUFALO
MODELO	POSICIÓN	ESPECIFICACIÓN	Ø SUPERIOR	Ø INFERIOR	ALTURA	
02 - 05	CAJA	DER / IZQ	2.1	7.8	8.6	<b>MC-N-223</b>



**MC-N-223**

APRIO		C M				No. BUFALO
MODELO	POSICIÓN	ESPECIFICACIÓN	Ø SUPERIOR	Ø INFERIOR	ALTURA	
07 - 10	CAJA	DER / IZQ	4.1	7.6	7.2	<b>MC-N-229</b>
	DIRECCIÓN	DER / IZQ	0.9	4.1	14.5	<b>MC-N-232</b>



**MC-N-229**

**MC-N-232**

CAMIONETAS AMERICANAS 4 X 4		C M				No. BUFALO
MODELO	POSICIÓN	ESPECIFICACIÓN	Ø SUPERIOR	Ø INFERIOR	ALTURA	
	RUEDA	DER / IZQ	2.3	8.0	8.0	<b>MC-N-228</b>
	CAJA	DER / IZQ	2.5	8.4	9.4	<b>MC-N-224</b>



**MC-N-224**

**MC-N-228**

QUEST		C M				No. BUFALO
MODELO	POSICIÓN	ESPECIFICACIÓN	Ø SUPERIOR	Ø INFERIOR	ALTURA	
93 - 04	RUEDA	DER / IZQ	2.3	8.0	8.0	<b>MC-N-228</b>
	DIRECCIÓN	DER / IZQ	1.4	5.2	20	<b>MC-N-233</b>



**MC-N-228**

**MC-N-233**



# N I S S A N

**AUTOS Y CAMIONETAS**

MAXIMA			C M			No. BUFALO
MODELO	POSICIÓN	ESPECIFICACIÓN	Ø SUPERIOR	Ø INFERIOR	ALTURA	
	RUEDA	DER / IZQ	2.5	9.8	8.0	<b>MC-N-218</b>
	DIRECCIÓN	DER / IZQ	1.4	5.0	14.8	<b>MC-N-234</b>



**MC-N-218**

**MC-N-234**

MICRA			C M			No. BUFALO
MODELO	POSICIÓN	ESPECIFICACIÓN	Ø SUPERIOR	Ø INFERIOR	ALTURA	
04 - 07	RUEDA	DER / IZQ	2.5	8.3	10.0	<b>MC-N-225</b>
	CAJA	DER / IZQ	2.3	8.0	8.6	<b>MC-N-226</b>
	DIRECCIÓN	DER / IZQ	1.5	4.5	18.4	<b>MC-N-227</b>



**MC-N-225**

**MC-N-226**

**MC-N-227**

PLATINA			C M			No. BUFALO
MODELO	POSICIÓN	ESPECIFICACIÓN	Ø SUPERIOR	Ø INFERIOR	ALTURA	
02 - 08	RUEDA	DER / IZQ / STD	2.5	8.2	11.5	<b>MC-N-217</b>
	RUEDA	DER / IZQ / AUT	2.5	8.3	10	<b>MC-N-220</b>
	CAJA	DER / IZQ / STD	4.1	8.6	8.8	<b>MC-N-216</b>
	CAJA	DER / IZQ / AUT	7.4	2.5	9.2	<b>MC-N-219</b>
	DIRECCIÓN	DER / IZQ	4.3	1.1	16.3	<b>MC-N-221</b>



**MC-N-216**

**MC-N-217**

**MC-N-219**

**MC-N-220**

**MC-N-221**

# CALIDAD Y GARANTÍA

SENTRA, LUCINO			C M			
MODELO	POSICIÓN	ESPECIFICACIÓN	Ø SUPERIOR	Ø INFERIOR	ALTURA	No. <i>BUFALO</i>
96 - 98	RUEDA	DER / IZQ	2.3	8.5	8.9	<b>MC-N-205</b>
	CAJA	DER / IZQ	1.9	7.6	10.4	<b>MC-N-206</b>
	DIRECCIÓN	DER / IZQ / <i>HIDRÁULICA</i>	1.2	4.5	18.5	<b>MC-N-208</b>
	DIRECCIÓN	DER / STD	1.2	3.6	14.6	<b>MC-N-210</b>
	DIRECCIÓN	IZQ / STD	1.3	3.2	20.0	<b>MC-N-209</b>
98 - 04	RUEDA	DER / IZQ	2.4	7.7	10.4	<b>MC-N-213</b>
	CAJA	DER / IZQ	2.1	7.8	8.6	<b>MC-N-214</b>
	DIRECCIÓN	DER / IZQ	1.5	4.5	18.4	<b>MC-N-227</b>
05 - 09	RUEDA	DER / IZQ	2.4	8.2	9.3	<b>MC-N-231</b>
	CAJA	DER / IZQ / <i>TRIPOIDE</i>	2.5	9.0	8.5	<b>MC-N-236</b>
	DIRECCIÓN	DER / IZQ	1.5	5.0	16.0	<b>MC-N-237</b>



TIIDA			C M			
MODELO	POSICIÓN	ESPECIFICACIÓN	Ø SUPERIOR	Ø INFERIOR	ALTURA	No. <i>BUFALO</i>
06 - 11	RUEDA	DER / IZQ	2.4	8.2	9.3	<b>MC-N-231</b>
	DIRECCIÓN	DER / IZQ	0.9	4.1	14.5	<b>MC-N-232</b>



TSUBAME			C M			
MODELO	POSICIÓN	ESPECIFICACIÓN	Ø SUPERIOR	Ø INFERIOR	ALTURA	No. <i>BUFALO</i>
94 - 04	RUEDA	DER / IZQ	2.3	8.3	8.5	<b>MC-N-212</b>
	CAJA	DER / IZQ	1.6	7.2	10.9	<b>MC-N-211</b>
	CAJA	DER / IZQ / <i>TRIPOIDE</i>	2.4	8.1	8.7	<b>MC-N-215</b>
	DIRECCIÓN	IZQ / STD	1.2	3.6	14.6	<b>MC-N-210</b>
	DIRECCIÓN	DER / STD	1.3	3.2	20.0	<b>MC-N-209</b>
	DIRECCIÓN	DER / IZQ / <i>HIDRÁULICA</i>	1.2	4.5	18.5	<b>MC-N-208</b>



# N I S S A N

**AUTOS Y CAMIONETAS**

## TSUBAME

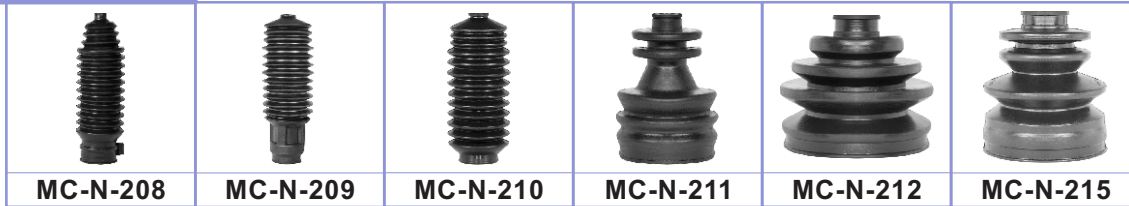

## TSURU I

C M

MODELO	POSICIÓN	ESPECIFICACIÓN	Ø SUPERIOR	Ø INFERIOR	ALTURA	No. BUFALO
84 - 87	RUEDA	DER / IZQ	2.0	7.9	8.0	<b>MC-N-204</b>
	CAJA	DER / IZQ	2.5	6.7	11.6	<b>MC-N-203</b>
	DIRECCIÓN	IZQ / STD	1.2	3.3	14.4	<b>MC-N-200</b>
	DIRECCIÓN	DER / STD	1.2	3.2	19.6	<b>MC-N-201</b>
	DIRECCIÓN	IZQ / HIDRÁULICA	1.2	3.9	13.6	<b>MC-N-207</b>
	DIRECCIÓN	DER / HIDRÁULICA	1.2	4.6	14.4	<b>MC-N-202</b>

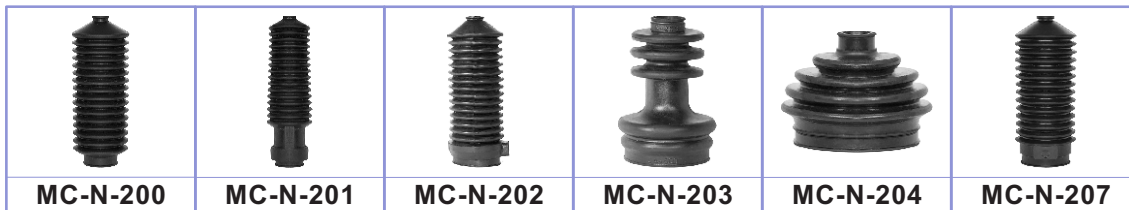

## TSURU II

C M

MODELO	POSICIÓN	ESPECIFICACIÓN	Ø SUPERIOR	Ø INFERIOR	ALTURA	No. BUFALO
88 - 91	RUEDA	DER / IZQ	2.3	8.5	8.9	<b>MC-N-205</b>
	CAJA	DER / IZQ	1.9	7.6	10.4	<b>MC-N-206</b>
	DIRECCIÓN	IZQ / STD	1.2	3.3	14.4	<b>MC-N-200</b>
	DIRECCIÓN	DER / STD	1.2	3.2	19.6	<b>MC-N-201</b>
	DIRECCIÓN	IZQ / HIDRÁULICA	1.2	3.9	13.6	<b>MC-N-207</b>
	DIRECCIÓN	DER / HIDRÁULICA	1.2	4.6	14.4	<b>MC-N-202</b>



## TSURU III

C M

MODELO	POSICIÓN	ESPECIFICACIÓN	Ø SUPERIOR	Ø INFERIOR	ALTURA	No. BUFALO
92 - 05	RUEDA	DER / IZQ	2.3	8.3	8.5	<b>MC-N-212</b>
	CAJA	DER / IZQ	1.6	7.2	10.9	<b>MC-N-211</b>
GS	CAJA	DER / IZQ / TRIPOIDE	2.4	8.1	8.7	<b>MC-N-215</b>
	DIRECCIÓN	DER / IZQ / STD	1.2	3.6	14.6	<b>MC-N-210</b>
	DIRECCIÓN	DER / IZQ / STD	1.3	3.2	20.0	<b>MC-N-209</b>
	DIRECCIÓN	DER / IZQ	1.2	4.5	18.5	<b>MC-N-208</b>

CONTINÚA...

# N I S S A N

**AUTOS Y CAMIONETAS**



TSURU III		C M				
MODELO	POSICIÓN	ESPECIFICACIÓN	Ø SUPERIOR	Ø INFERIOR	ALTURA	No. BUFALO
05 - 11	RUEDA	DER / IZQ	2.4	8.2	9.3	<b>MC-N-231</b>
	CAJA	DER / IZQ / TRIPOIDE	2.5	7.8	10.6	<b>MC-N-230</b>



X-TERRA, X-TRAIL		C M				
MODELO	POSICIÓN	ESPECIFICACIÓN	Ø SUPERIOR	Ø INFERIOR	ALTURA	No. BUFALO
00 - 07	RUEDA	DER / IZQ	2.8	9.6	11	<b>MC-N-235</b>
	CAJA	DER / IZQ / TRIPOIDE	2.5	9.0	8.5	<b>MC-N-236</b>
	DIRECCIÓN	DER / IZQ	1.5	5.0	16	<b>MC-N-237</b>



URVAN		C M				
MODELO	POSICIÓN	ESPECIFICACIÓN	Ø SUPERIOR	Ø INFERIOR	ALTURA	No. BUFALO
00 - 11	DIRECCIÓN	DER / IZQ	2.1	5.0	17.5	<b>MC-N-222</b>



# CALIDAD Y GARANTÍA





# PEUGEOT

AUTOS Y CAMIONETAS

206		C M				
MODELO	POSICIÓN	ESPECIFICACIÓN	Ø SUPERIOR	Ø INFERIOR	ALTURA	No. BUFALO
00 - 08	RUEDA	DER / IZQ	3.7	7.5	10.6	MC-P-1000
	CAJA	DER / IZQ / STD	2.7	7.2	7.9	MC-P-1001
	CAJA	DER / IZQ / AUT	3.3	7.6	9.3	MC-P-1002
	DIRECCIÓN	DER / IZQ / HIDRÁULICA	1.6	5.9	18.0	MC-P-1003



# RENAULT

AUTOS Y CAMIONETAS

ALIANCE, ENCORE		C M				
MODELO	POSICIÓN	ESPECIFICACIÓN	Ø SUPERIOR	Ø INFERIOR	ALTURA	No. BUFALO
85 - 86	RUEDA	DER / IZQ	2.9	8.2	11.2	MC-R-313
	CAJA	DER / IZQ	3.4	8.4	10.3	MC-R-312

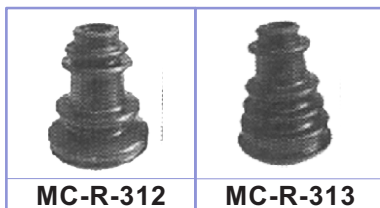

CLIO		C M				
MODELO	POSICIÓN	ESPECIFICACIÓN	Ø SUPERIOR	Ø INFERIOR	ALTURA	No. BUFALO
02 - 08	RUEDA	DER / IZQ / STD	2.5	8.7	11.5	MC-R-320
	RUEDA	DER / IZQ / AUT	2.5	8.3	10.0	MC-R-322
	CAJA	DER / IZQ / STD	4.1	8.6	8.8	MC-R-319
	CAJA	DER / IZQ / AUT / TRIPOIDE	2.5	7.4	9.2	MC-R-321
	DIRECCIÓN	DER / IZQ	1.1	4.3	16.3	MC-R-323



R-5		C M				
MODELO	POSICIÓN	ESPECIFICACIÓN	Ø SUPERIOR	Ø INFERIOR	ALTURA	No. BUFALO
74 - 84	RUEDA	DER / IZQ	2.1	7.4	9.4	<b>MC-R-303</b>
	CAJA	DER / IZQ	1.8	7.1	12.3	<b>MC-R-302</b>
	DIRECCIÓN	DER / IZQ / STD	1.1	3.4	14.6	<b>MC-R-300</b>



R-12		C M				
MODELO	POSICIÓN	ESPECIFICACIÓN	Ø SUPERIOR	Ø INFERIOR	ALTURA	No. BUFALO
74 - 84	RUEDA	DER / IZQ	2.1	7.4	9.4	<b>MC-R-303</b>
	CAJA	DER / IZQ	1.6	8.1	9.8	<b>MC-R-306</b>
	CAJA	DER / IZQ	2.0	7.8	10.8	<b>MC-R-307</b>
	DIRECCIÓN	DER / IZQ / STD	1.1	3.4	14.8	<b>MC-R-300</b>



R-18		C M				
MODELO	POSICIÓN	ESPECIFICACIÓN	Ø SUPERIOR	Ø INFERIOR	ALTURA	No. BUFALO
74 - 84	RUEDA	DER / IZQ / 2 LTS.	2.1	7.4	9.4	<b>MC-R-303</b>
	RUEDA	DER / IZQ / 2 LTS / NACIONAL	2.5	6.7	11.6	<b>MC-R-304</b>
	RUEDA	DER / IZQ / FRANCES ESPECIAL	3.5	8.0	11.0	<b>MC-R-310</b>
	CAJA	DER / IZQ / 2 LTS.	1.8	7.1	12.3	<b>MC-R-302</b>
	CAJA	DER / IZQ / 2 LTS / NACIONAL	2.2	8.0	7.0	<b>MC-R-305</b>
	CAJA	DER / IZQ / FRANCES	3.4	8.4	10.3	<b>MC-R-308</b>
	DIRECCIÓN	DER / IZQ / STD	1.1	3.4	14.6	<b>MC-R-300</b>



MEGANE I, II		C M				
MODELO	POSICIÓN	ESPECIFICACIÓN	Ø SUPERIOR	Ø INFERIOR	ALTURA	No. BUFALO
01 - 09	RUEDA	DER / IZQ	2.5	8.0	10.0	<b>MC-R-324</b>
	RUEDA	DER / IZQ	2.5	7.5	9.5	<b>MC-R-325</b>

CONTINÚA...



# RENAULT

AUTOS Y CAMIONETAS

## MEGANE I, II



MC-R-324

MC-R-325

# SEAT

AUTOS Y CAMIONETAS

## ALHAMBRA

C M

MODELO	POSICIÓN	ESPECIFICACIÓN	Ø SUPERIOR	Ø INFERIOR	ALTURA	No. BUFALO
02 - 08	CAJA	DER / IZQ / TRIPOIDE	2.4	8.2	8.5	MC-S-904



MC-S-904

## CORDOBA

C M

MODELO	POSICIÓN	ESPECIFICACIÓN	Ø SUPERIOR	Ø INFERIOR	ALTURA	No. BUFALO
02 - 05	RUEDA	DER / IZQ	2.3	8.3	9.5	MC-S-901
	CAJA	DER / IZQ	2.4	6.8	11.7	MC-S-902
	DIRECCIÓN	DER / IZQ / HIDRÁULICA	1.3	4.1	17.5	MC-S-903



MC-S-901

MC-S-902

MC-S-903

## IBIZA

C M

MODELO	POSICIÓN	ESPECIFICACIÓN	Ø SUPERIOR	Ø INFERIOR	ALTURA	No. BUFALO
01 - 05	RUEDA	DER / IZQ	2.0	7.8	8.4	MC-S-900
	CAJA	DER / IZQ	2.4	6.8	11.7	MC-S-902
	DIRECCIÓN	DER / IZQ / HIDRÁULICA	1.3	4.1	17.5	MC-S-903



MC-S-900

MC-S-902

MC-S-903

LEÓN			C M			
MODELO	POSICIÓN	ESPECIFICACIÓN	Ø SUPERIOR	Ø INFERIOR	ALTURA	No. <i>BUFALO</i>
01 - 05	RUEDA	DER / IZQ	2.0	7.8	8.4	<b>MC-S-900</b>
02 - 08	CAJA	DER / IZQ	2.4	6.8	11.7	<b>MC-S-902</b>
01 - 05	DIRECCIÓN	DER / IZQ / <i>HIDRÁULICA</i>	1.3	4.1	17.5	<b>MC-S-903</b>
06 - 08	RUEDA	DER / IZQ / STD	2.3	8.3	9.5	<b>MC-S-901</b>



TOLEDO			C M			
MODELO	POSICIÓN	ESPECIFICACIÓN	Ø SUPERIOR	Ø INFERIOR	ALTURA	No. <i>BUFALO</i>
01 - 05	RUEDA	DER / IZQ	2.0	7.8	8.4	<b>MC-S-900</b>
02 - 08	CAJA	DER / IZQ	2.4	6.8	11.7	<b>MC-S-902</b>
01 - 05	DIRECCIÓN	DER / IZQ / <i>HIDRÁULICA</i>	1.3	4.1	17.5	<b>MC-S-903</b>
06 - 08	RUEDA	DER / IZQ / STD	2.3	8.3	9.5	<b>MC-S-901</b>



MR



MR

# TOYOTA

AUTOS Y CAMIONETAS

CAMIONETAS PICK UP 4 X 4			C M			
MODELO	POSICIÓN	ESPECIFICACIÓN	Ø SUPERIOR	Ø INFERIOR	ALTURA	No. BUFALO
84 - 05	RUEDA	DER / IZQ	2.8	9.5	10.1	MC-T-1100
	RUEDA	DER / IZQ	2.6	9.0	8.2	MC-T-1101
	CAJA	DER / IZQ	2.7	8.4	10.4	MC-T-1102



TACOMA			C M			
MODELO	POSICIÓN	ESPECIFICACIÓN	Ø SUPERIOR	Ø INFERIOR	ALTURA	No. BUFALO
98 - 09	RUEDA	DER / IZQ	2.5	9.1	10.5	MC-T-1104
	CAJA	DER / IZQ / TRIPOIDE	2.2	8.7	9.9	MC-T-1105
00 - 04	DIRECCIÓN	DER / IZQ	2.8	5.7	20.4	MC-T-1103
	DIRECCIÓN	DER / IZQ / CORTA	1.4	4.4	16.2	MC-T-1106



# UNIVERSALES

AUTOS Y CAMIONETAS

UNIVERSALES			C M			
MODELO	POSICIÓN	ESPECIFICACIÓN	Ø SUPERIOR	Ø INFERIOR	ALTURA	No. BUFALO
VARIOS	RUEDA	DER / IZQ / BOCA GRANDE	2.5	8.0	7.0	MC-UA-501
	RUEDA	DER / IZQ	2.2	8.0	7.0	MC-UA-501-A
	CAJA	DER / IZQ / STD	2.5	6.7	11.6	MC-UA-500
	CAJA	DER / IZQ / BOCA GRANDE	2.2	7.1	10.9	MC-UA-500-A
	RUEDA	DER / IZQ / GRANDE	2.3	10.8	15.3	MC-UA-503

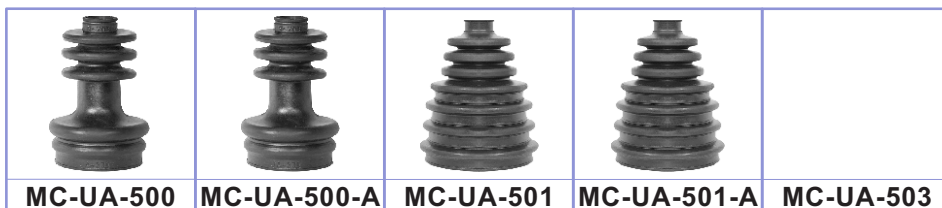

UNIVERSALES CAMIONETAS AMERICANAS			C M			No. BUFALO
MODELO	POSICIÓN	ESPECIFICACIÓN	Ø SUPERIOR	Ø INFERIOR	ALTURA	
VARIOS	RUEDA	DER / IZQ	3.3	11.3	10.8	<b>MC-UA-502</b>



**MC-UA-502**

# VOLKSWAGEN

AUTOS Y CAMIONETAS

BEETLE		C M			No. BUFALO	
MODELO	POSICIÓN	ESPECIFICACIÓN	Ø SUPERIOR	Ø INFERIOR	ALTURA	
98 - 08	RUEDA	DER / IZQ	2.3	8.3	9.5	<b>MC-V-111</b>
	CAJA	DER / IZQ / STD	2.2	6.7	10.2	<b>MC-V-118</b>
	CAJA	DER / IZQ / AUT	2.2	8.3	9.1	<b>MC-V-117</b>
	DIRECCIÓN	DER / IZQ / HIDRÁULICA	1.3	4.1	17.5	<b>MC-V-104</b>



**MC-V-104**

**MC-V-111**

**MC-V-117**

**MC-V-118**

BORA		C M			No. BUFALO	
MODELO	POSICIÓN	ESPECIFICACIÓN	Ø SUPERIOR	Ø INFERIOR	ALTURA	
06 - 07	RUEDA	DER / IZQ	2.5	8.8	9.6	<b>MC-V-122</b>
	CAJA	DER / IZQ	2.4	8.4	10.0	<b>MC-V-123</b>
	CAJA	DER / IZQ	2.4	8.4	11.5	<b>MC-V-124</b>
08 - 10	RUEDA	DER / IZQ	3.1	9.9	11.4	<b>MC-V-125</b>
	CAJA	DER / IZQ	2.4	8.2	10.5	<b>MC-V-121</b>



**MC-V-121**

**MC-V-122**

**MC-V-123**

**MC-V-124**

**MC-V-125**



# VOLKSWAGEN

**AUTOS Y CAMIONETAS**

## CARIBE, ATLANTIC

MODELO	POSICIÓN	ESPECIFICACIÓN	Ø SUPERIOR	Ø INFERIOR	ALTURA	No. BUFALO
77 - 87	RUEDA	DER / IZQ	2.0	7.8	8.4	<b>MC-V-104</b>
	CAJA	DER / IZQ	2.4	5.9	8.8	<b>MC-V-105</b>
	DIRECCIÓN	DER / IZQ	2.5	4.1	14.0	<b>MC-V-100</b>
	DIRECCIÓN	DER / IZQ	2.5	3.5	14.0	<b>MC-V-101</b>



## COMBI, CARAVELLE

MODELO	POSICIÓN	ESPECIFICACIÓN	Ø SUPERIOR	Ø INFERIOR	ALTURA	No. BUFALO
70 - 01	CAJA	DER / IZQ	2.0	6.8	9.6	<b>MC-V-108</b>

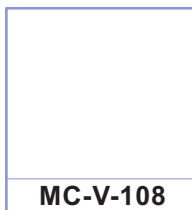

## CORSA

MODELO	POSICIÓN	ESPECIFICACIÓN	Ø SUPERIOR	Ø INFERIOR	ALTURA	No. BUFALO
85 - 87	RUEDA	DER / IZQ	2.0	7.8	8.4	<b>MC-V-104</b>
	CAJA	DER / IZQ	2.4	5.9	8.8	<b>MC-V-105</b>



## DERBY

MODELO	POSICIÓN	ESPECIFICACIÓN	Ø SUPERIOR	Ø INFERIOR	ALTURA	No. BUFALO
95 - 09	RUEDA	DER / IZQ	2.3	8.3	9.5	<b>MC-V-111</b>
	CAJA	DER / IZQ	3.7	6.8	11.0	<b>MC-V-110</b>

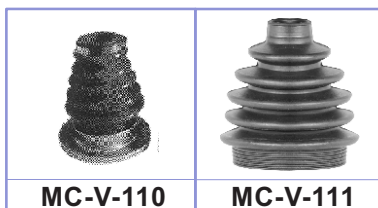

## EUROVAN

MODELO	POSICIÓN	ESPECIFICACIÓN	Ø SUPERIOR	Ø INFERIOR	ALTURA	No. <i>BUFALO</i>
00 - 09	RUEDA	DER / IZQ	2.9	9.4	12.9	<b>MC-V-114</b>
	CAJA	DER / IZQ	2.5	5.7	9.6	<b>MC-V-115</b>
	DIRECCIÓN	DER / IZQ	2.5	5.4	13.4	<b>MC-V-116</b>

## EUROVAN DIESEL

MODELO	POSICIÓN	ESPECIFICACIÓN	Ø SUPERIOR	Ø INFERIOR	ALTURA	No. <i>BUFALO</i>
	RUEDA	DER / IZQ	2.9	10.0	13.5	<b>MC-V-127</b>



**MC-V-114**

**MC-V-115**

**MC-V-116**



**MC-V-127**

## GOLF A2, JETTA A2

MODELO	POSICIÓN	ESPECIFICACIÓN	Ø SUPERIOR	Ø INFERIOR	ALTURA	No. <i>BUFALO</i>
87 - 92	RUEDA	DER / IZQ	2.2	7.8	8.1	<b>MC-V-106</b>
	CAJA	DER / IZQ	2.4	5.9	8.8	<b>MC-V-105</b>
	DIRECCIÓN	DER / IZQ / STD	2.5	3.9	12.1	<b>MC-V-102</b>
	DIRECCIÓN	DER / IZQ / HIDRÁULICA	1.3	4.1	17.5	<b>MC-V-103</b>

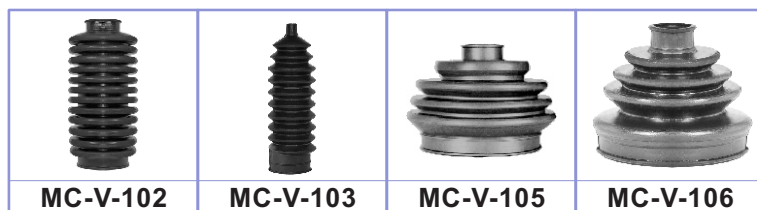

**MC-V-102**

**MC-V-103**

**MC-V-105**

**MC-V-106**

## GOLF A3, JETTA A3

MODELO	POSICIÓN	ESPECIFICACIÓN	Ø SUPERIOR	Ø INFERIOR	ALTURA	No. <i>BUFALO</i>
92 - 99	RUEDA	DER / IZQ	2.3	8.3	9.5	<b>MC-V-111</b>
	CAJA	IZQ	2.4	6.8	11.7	<b>MC-V-112</b>
	CAJA	DER	3.7	6.8	11.0	<b>MC-V-110</b>
	DIRECCIÓN	DER / IZQ / STD	2.5	3.9	12.1	<b>MC-V-102</b>
	DIRECCIÓN	DER / IZQ / HIDRÁULICA	1.3	4.1	17.5	<b>MC-V-103</b>



**MC-V-102**

**MC-V-103**

**MC-V-110**

**MC-V-111**

**MC-V-112**





# VOLKSWAGEN

**AUTOS Y CAMIONETAS**

GOLF A4, JETTA A4			C M			No. BUFALO
MODELO	POSICIÓN	ESPECIFICACIÓN	Ø SUPERIOR	Ø INFERIOR	ALTURA	
98 - 10	RUEDA	DER / IZQ	2.3	8.3	9.5	MC-V-111
98 - 06	CAJA	DER / IZQ / STD	2.2	6.7	10.2	MC-V-118
	CAJA	DER / IZQ / AUT	2.2	8.3	9.1	MC-V-117
07 - 10	CAJA	DER / IZQ / TRIPOIDE	2.4	8.2	10.5	MC-V-121
	CAJA	DER / IZQ	3.7	6.8	11.0	MC-V-110
	CAJA	DER / IZQ / CORTA	2.4	6.8	11.7	MC-V-112
98 - 04	DIRECCIÓN	DER / IZQ / CORTA	1.3	4.9	16.6	MC-V-113
05 - 09	DIRECCIÓN	DER / IZQ / CORTA	1.5	4.5	18.4	MC-V-119



GOLF VR6, JETTA VR6			C M			No. BUFALO
MODELO	POSICIÓN	ESPECIFICACIÓN	Ø SUPERIOR	Ø INFERIOR	ALTURA	
96 - 04	RUEDA	DER / IZQ	2.3	8.3	9.5	MC-V-111
	CAJA	IZQ	2.1	6.8	11.6	MC-V-109
	CAJA	IZQ	2.4	6.8	11.7	MC-V-112
	CAJA	DER	3.7	6.0	11.0	MC-V-110
96 - 99	DIRECCIÓN	DER / IZQ / STD	2.5	3.9	12.1	MC-V-102
00 - 04	DIRECCIÓN	DER / IZQ / HIDRÁULICA	1.3	4.1	17.5	MC-V-103
	DIRECCIÓN	DER / IZQ	1.3	4.9	16.6	MC-V-113



POINTER			C M			No. BUFALO
MODELO	POSICIÓN	ESPECIFICACIÓN	Ø SUPERIOR	Ø INFERIOR	ALTURA	
97 - 09	RUEDA	DER / IZQ	2.0	7.8	8.4	MC-V-104
	CAJA	IZQ	2.4	5.9	8.8	MC-V-105
	DIRECCIÓN	DER / IZQ	2.3	4.2	14.0	MC-V-120

CONTINÚA...

## POINTER



MC-V-104

MC-V-105

MC-V-120

## SHARAN

		C M				
MODELO	POSICIÓN	ESPECIFICACIÓN	Ø SUPERIOR	Ø INFERIOR	ALTURA	No. <i>BUFALO</i>
02 - 08	CAJA	DER / IZQ / TRIPOIDE	2.4	8.2	8.5	<b>MC-V-124</b>



MC-V-124

## VW SEDAN

		C M				
MODELO	POSICIÓN	ESPECIFICACIÓN	Ø SUPERIOR	Ø INFERIOR	ALTURA	No. <i>BUFALO</i>
70 - 04	CAJA	DER / IZQ	4.6	8.5	12.9	<b>MC-V-107</b>



MC-V-107